

NORTH
ENTRANCE

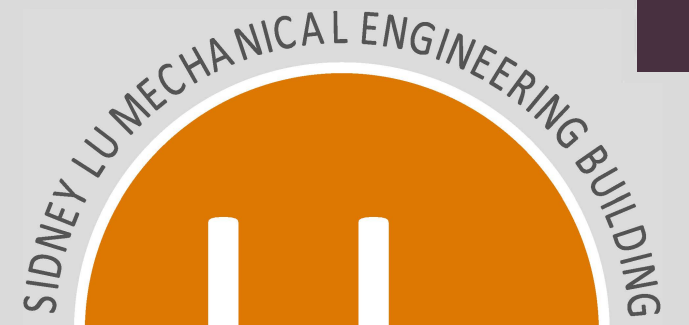

EAST
ENTRANCE

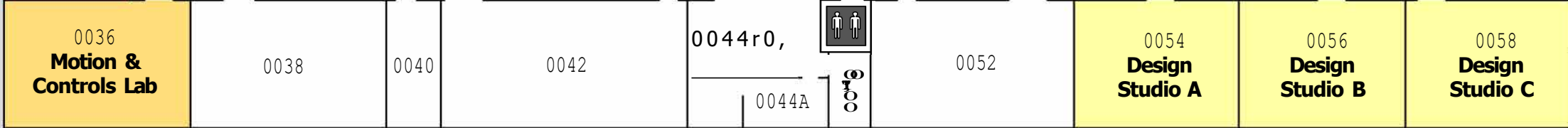

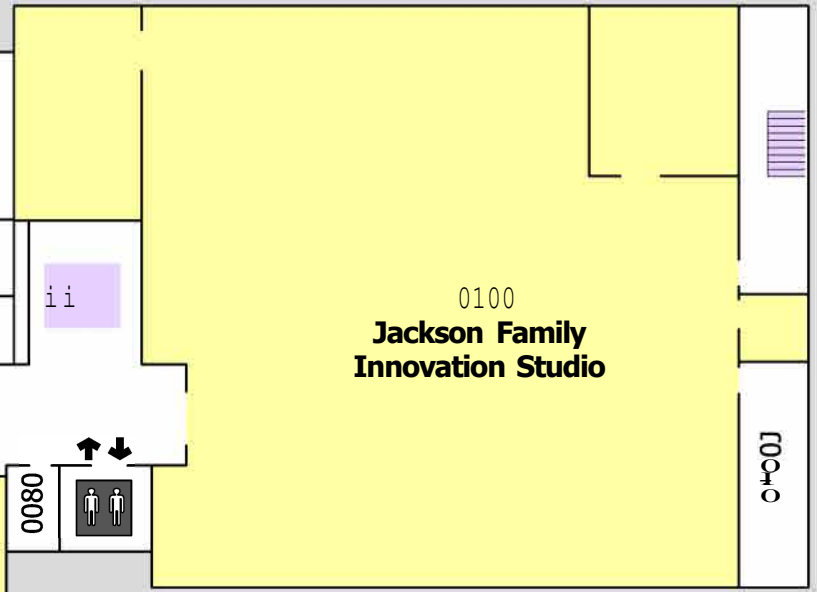
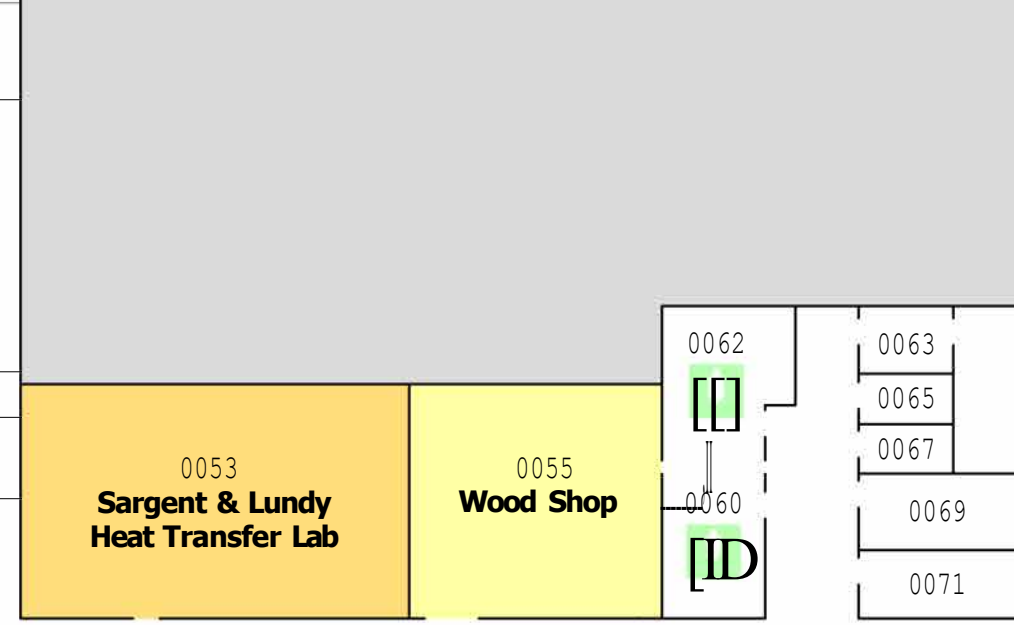
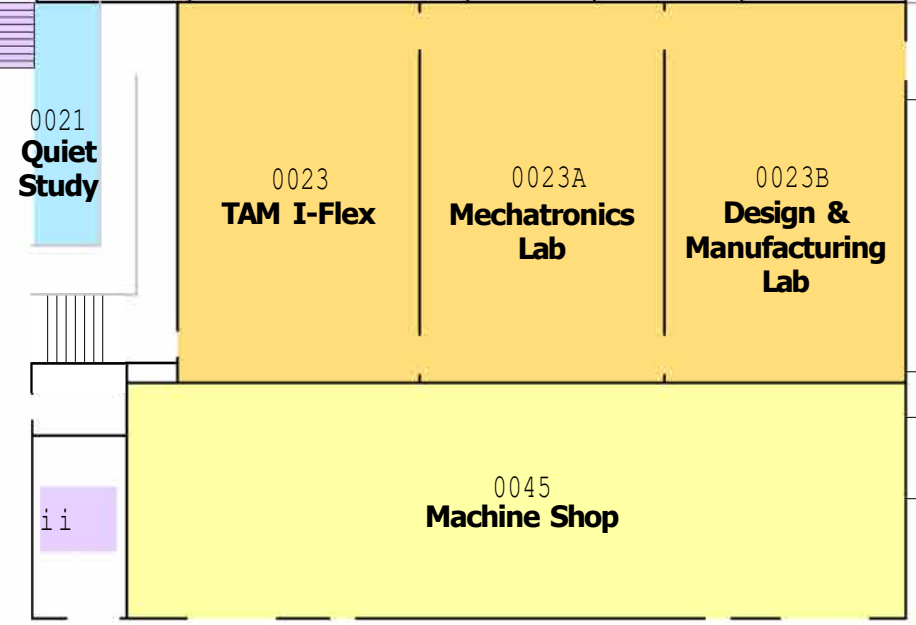
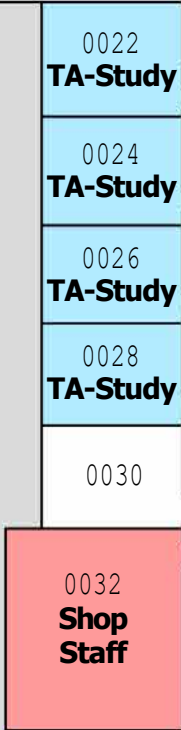
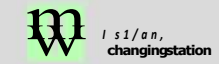

SIDNEY LU MECHANICAL ENGINEERING BUILDING

1

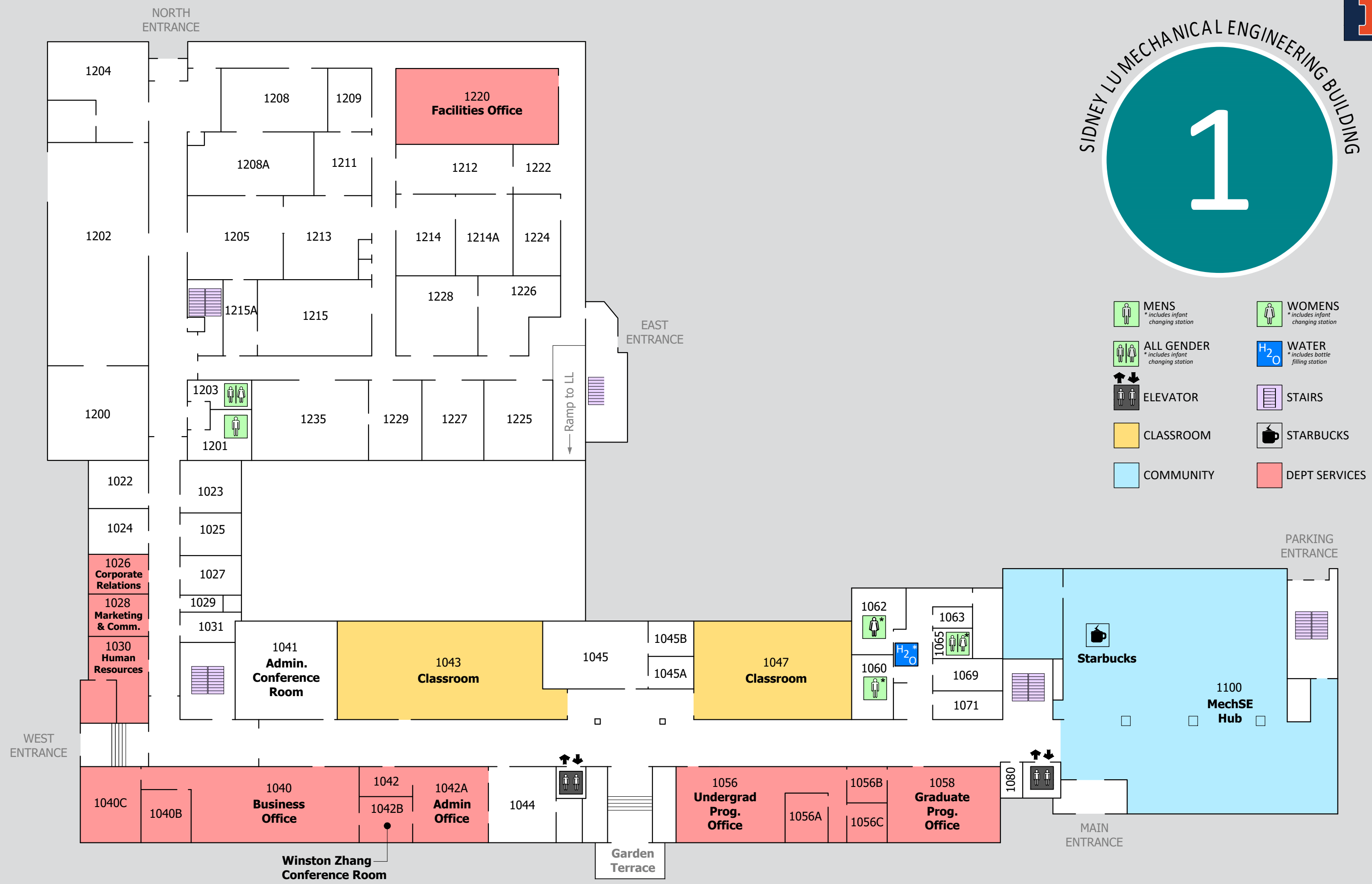







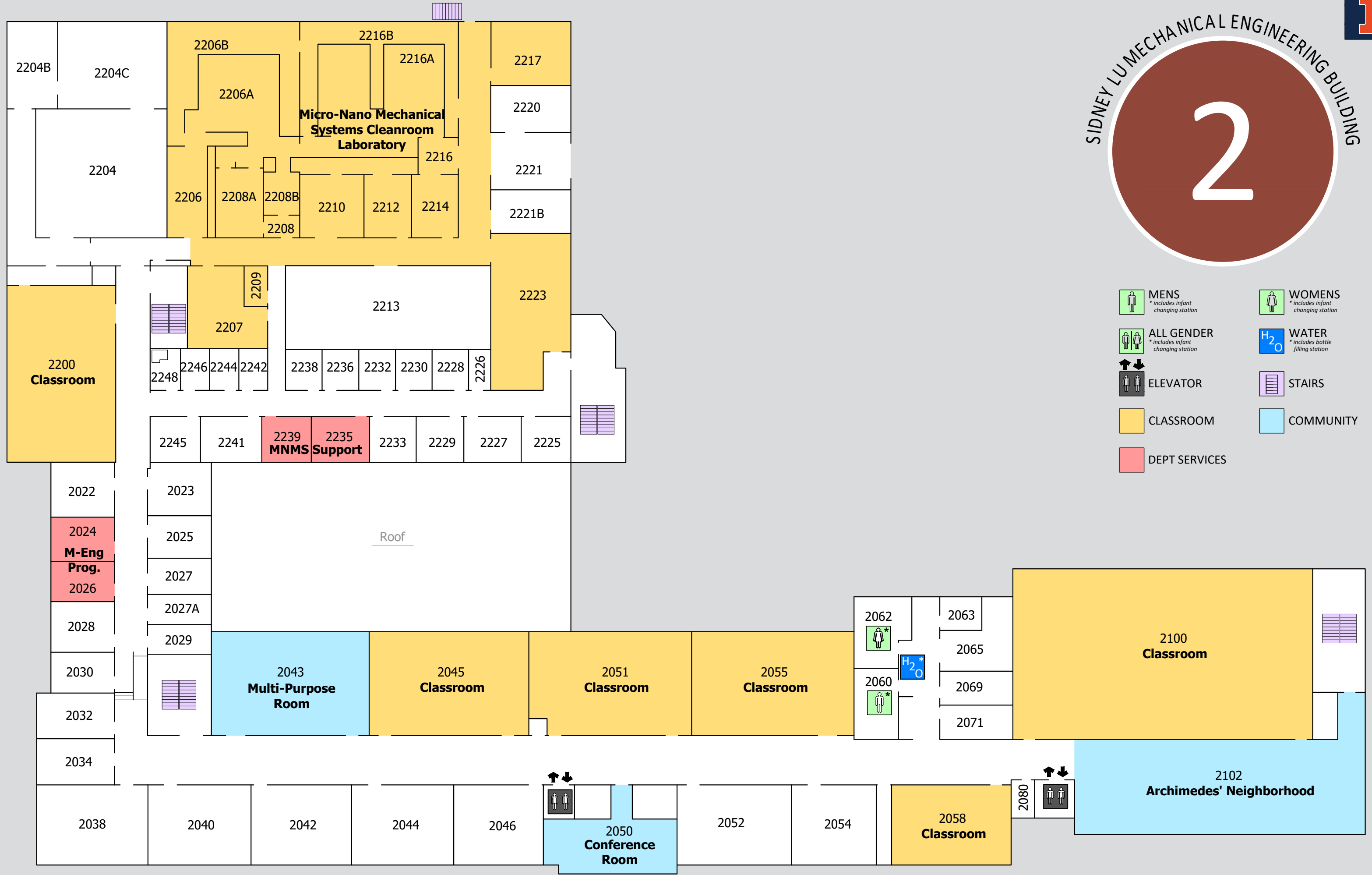



SIDNEY LU MECHANICAL ENGINEERING BUILDING

2









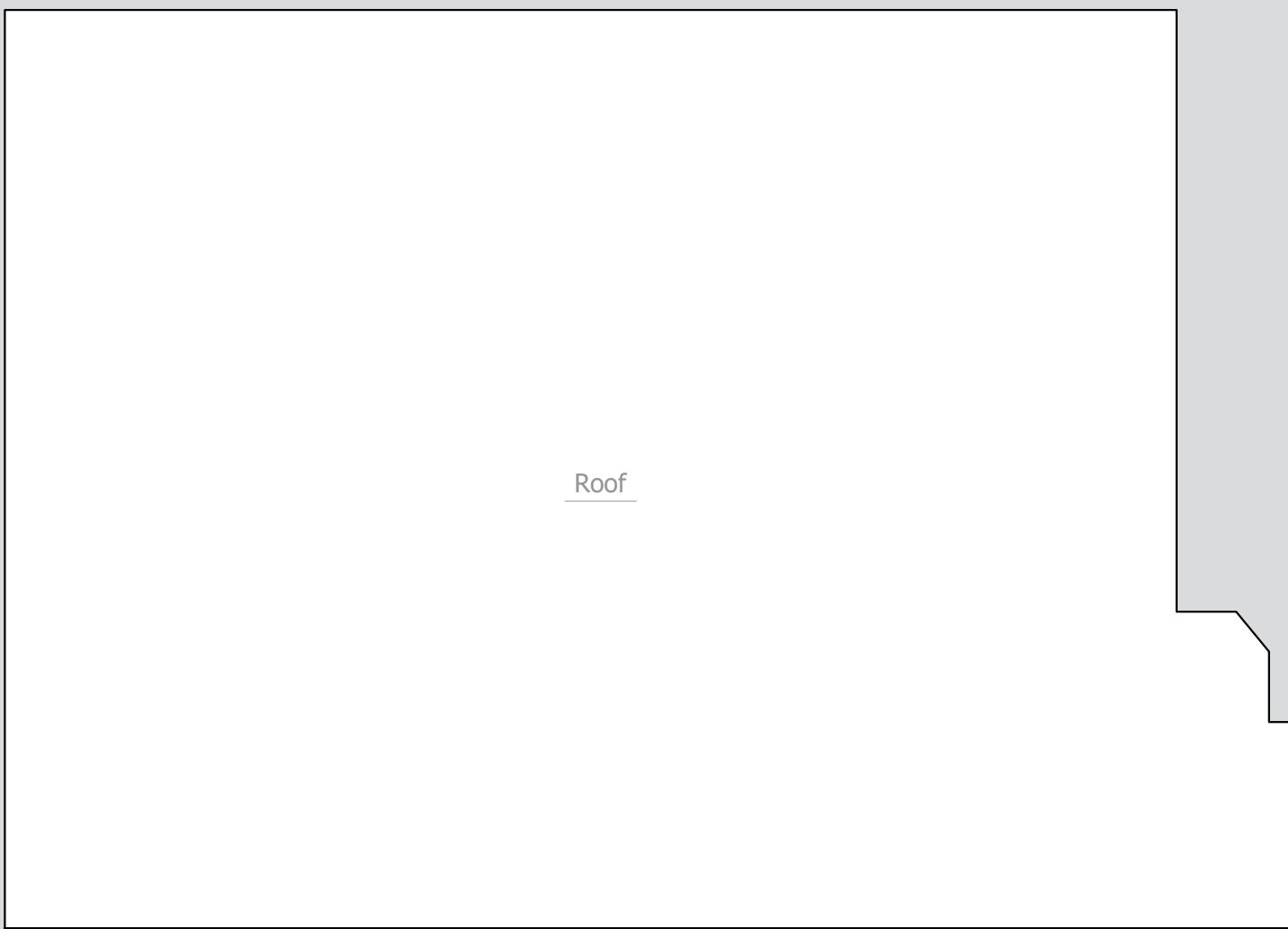

-  **MENS**
* includes infant changing station
-  **WOMENS**
* includes infant changing station
-  **ALL GENDER**
* includes infant changing station
-  **WATER**
* includes bottle filling station
-  **ELEVATOR**
-  **STAIRS**
-  **CLASSROOM**
-  **COMMUNITY**
-  **DEPT SERVICES**



SIDNEY LU MECHANICAL ENGINEERING BUILDING

3



-  **MENS**
* includes infant changing station
-  **WOMENS**
* includes infant changing station
-  **ALL GENDER**
* includes infant changing station
-  **WATER**
* includes bottle filling station
-  **ELEVATOR**
-  **STAIRS**
-  **CLASSROOM**
-  **COMMUNITY**

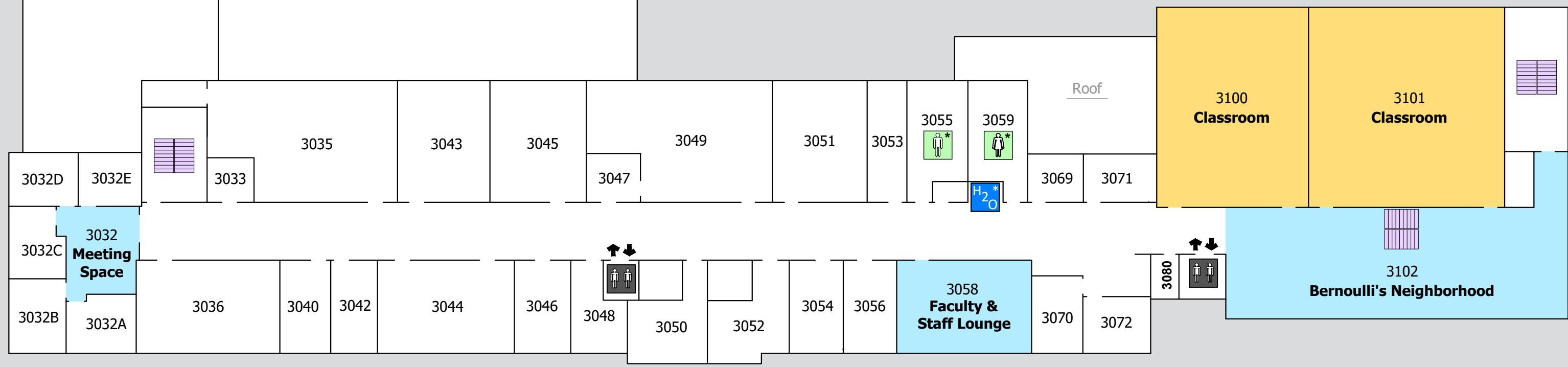



SIDNEY LU MECHANICAL ENGINEERING BUILDING

4

