

University of Illinois at Urbana-Champaign
**A History of the Department
of General Engineering**
1868–1995

by Jerry S. Dobrovolny, P.E.

The University of Illinois at Urbana-Champaign is an
equal opportunity and affirmative action institution.

Produced by the Engineering Publications Office,
112 Engineering Hall, 1308 W. Green St., Urbana, IL 61801 USA.
Designed by Richard F. Maul.

(4M)8/96

Contents

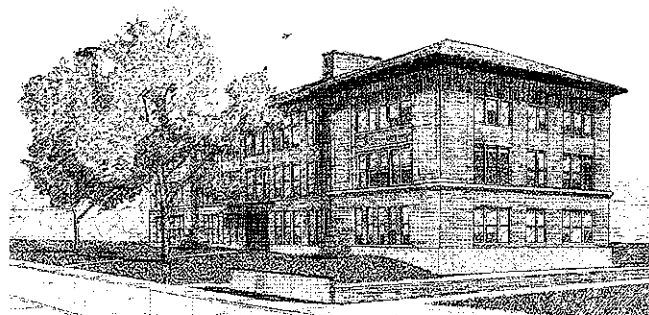

Foreword	ii
Chapter 1. The Department of General Engineering, An Historical Perspective	1
Chapter 2. Curriculum Development	11
Chapter 3. Master of Science in General Engineering	37
Chapter 4. Computer-aided Instruction and Laboratories	43
Chapter 5. Grants and Research Funding	57
Chapter 6. Student and Alumni Activities	67
Chapter 7. Contributions to Engineering Technology Education	75
Chapter 8. Members of the Faculty, 1911–95	85
Appendix	125

Foreword

The 75 years since Harvey H. Jordan took the reins of the newly designated Department of General Engineering Drawing have seen positive, dramatic changes that have resulted in the preparation of increasingly professional engineers who successfully specialize in many diverse fields. As you read through this history, you will be struck, as I was, that the mission of the department is more relevant today than ever before.

Technically trained individuals who also have a good grasp of business principles have traditionally been advanced into management positions in industry. For most of its history, the Department of General Engineering has been preparing this type of individual. We have used many unique and innovative programs along the way to meet the needs of the rapidly changing corporate world. Our curriculum is current, our senior design program is award-winning, and our laboratories incorporate the latest technology. Our concept of secondary fields has allowed our students the maximum choice in designing their own specialized segment of the curriculum.

As we look into the future, we are poised to become a leader in producing engineers who will meet the needs of society as we prepare to enter the next century. We are grateful to the many faculty and staff who, through the years, have brought us to where we are today. We are especially indebted to former Department Head Jerry S. Dobrovolny for his painstaking work in preparing this history, so that we can learn from our past and build upon it for our future.

Thomas F. Conry
Head, Department of General Engineering
June 1996

Acknowledgments

There were many people who provided the author with expertise in the various subject matter areas included in the text. A special thanks to Marilyn A. Butler, who transcribed the handwritten manuscript to readable type, and to Robert W. Evans, who assisted in the initial editing and compilation of photographs.

Others who assisted in the typing were Sheryl A. Hembrey, Michelle D. Tipsword, and Peggy R. Hills. Then, of course, thanks for the editing and final manuscript preparation go to Maureen D. Krauss and Ann R. Sapoznik.

A special recognition is due Dean W. L. Everitt and Dean Daniel C. Drucker, for without their support the Department of General Engineering would not be what it is today.

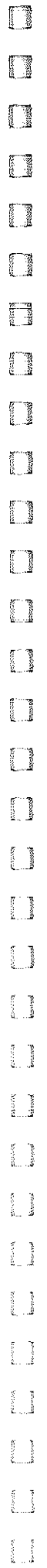

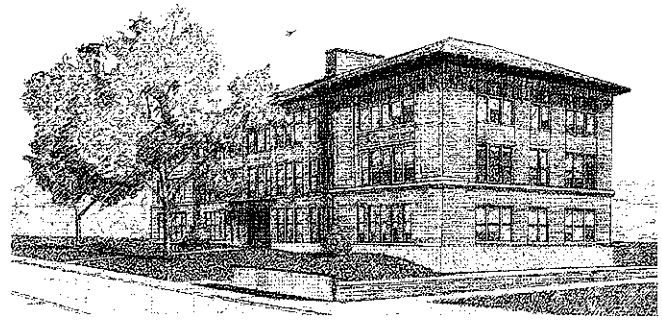

Chapter 1

The Department of General Engineering, An Historical Perspective

Prelude

This history is in two parts. The first will cover the period from 1868 to 1945. The material is based on the "History of the College of Engineering of the University of Illinois 1868-1945" written by Ira O. Baker, CE '74 and Everett E. King. Also included are items given orally to the writer by his senior colleagues.

The material covered since 1945 is based on the personal knowledge and records of the writer who holds a BS in general engineering.

In the Beginning (1868-1917)

To fully appreciate the evolution of both the Department of General Engineering and its general engineering curriculum, it is necessary to start from the early days of the College of Engineering. Three main elements had an interrelated impact upon the development of the department. They are the curricular developments in the College of Engineering, the personalities involved, and the commitment of physical facilities to the program.

The instructional program in engineering began in 1870 with the establishment of four so-called pioneer departments: Mechanical Science and Art, Civil Engineering, Mining Engineering and Metallurgy, and Architecture and Fine Arts. Many of the early courses were essentially manual in content and included work in the shop, mechanical drawing, and surveying. In the teaching of mechanical drawing, the classroom instruction was supplemented by the use of drawing problems called plates and models coordinated with shop practice; the machines so designed in the drafting room were later built in the shop by the students. From the beginning there has been a strong dedication to undergraduate teaching. Prior to 1893, mechanical drawing was taught at the freshman level and descriptive geometry at the junior level. These subjects were taught by various instructors. At times one subject was supervised by one person, the other by someone else, with no apparent coordination.

Some of the senior faculty who had supervised the courses for short periods felt it was important not only to teach the subject matter well but also to use the opportunity to provide a role model for the freshmen in engineering. These faculty members included such stalwart professors as Nathan C. Ricker, Ira O. Baker, S. W. Stratton, and Arthur N. Talbot.

As a result of their concerns, James David Phillips (Arch. 1893) was designated to be in charge of the program. His rank was assistant professor of engineering drawing. He was in charge from September 1893 to June 1902. Phillips organized the course work into two semesters in the freshman year. He also prepared a mimeographed text that produced significant improvement in both the quantity and the quality of student work. In his capacity as a role model, he had an outstanding reputation with the students for providing advice and counsel. As a result of his fine work, he was lured by the University of Wisconsin, to the assistant deanship of the College of Engineering and Mechanics and business manager of the university.

After Phillips left in 1902, a number of persons taught general engineering drawing. Between 1902 and 1904, the courses were taught by recent graduates of the college, namely, Robert C. Matthews (1902-05) and Hammond W. Whitsitt (1903-05). In 1904, Victor Tyson Wilson came on the staff as an assistant professor in charge of general engineering drawing and served in that capacity until 1907, when he resigned to become professor of engineering drawing at Pennsylvania State College. Charles Lenox McMaster then taught general engineering drawing from 1905 to 1910 and was in charge during the period 1907 to 1908.



An engineering drawing class at the turn of the century.

To further reflect the belief of the College of Engineering faculty in the importance of engineering drawing and descriptive geometry, the responsibility for the courses was vested in the Office of the Associate Dean when Assistant Dean Fred Duane Crawshaw assumed responsibility from 1908 to 1910.



Harry W. Miller

The next person to make a significant contribution to the pedagogic base of general engineering drawing was Harry W. Miller, who was in charge from 1910 to 1917. Miller was recognized for his administrative ability in organizing the subject matter efficiently. In 1912, with the help of the staff, he published two textbooks, *Mechanical Drafting* and *Descriptive Geometry*. He also published yearly specifications that assigned problems to be completed during each semester. He had a great interest in students and was noted for his helpfulness to them in their career orientations. He also served as assistant dean of the college from 1912 to 1917, and from May to August 1917 he was technical director of the School of Military Aeronautics. In August 1917 he resigned to enter military service in the Ordnance Division of the War Department. After a distinguished service record, he resigned with the rank of lieutenant colonel in 1921 and became professor of mechanical and engineering drawing at the University of Michigan.



Engineering Hall, 1903

In the early days prior to 1909, the space assigned to general engineering drawing was on the top floor of University Hall. Later that year, the teaching of engineering drawing was transferred to room 319 Engineering Hall, which occupied the entire third floor. The administrative office was in 218 Engineering Hall. When the Transportation Building was completed in 1912, the third floor was assigned to engineering drawing.

Transportation Building

The Transportation Building is located at 104 South Mathews Avenue, Urbana, facing west between Springfield Avenue and the Boneyard Creek. It has an interesting history in its own right. At the turn of the century, as the enrollment in the College of Engineering increased, the need for classrooms, offices, and drafting rooms was pressing. In particular, space was needed for the Department of Railway Engineering, which had been established in 1906. It had three distinct curricula: railway civil engineering, railway electrical engineering, and railway mechanical engineering.

The Transportation Building was designed by W. C. Zimmerman, state architect and designer of the Armory. The three-story building was designed with a pavilion on each end with a center section. The 45 feet of land on which the north pavilion would sit was part of a parcel known as the Conkle estate, tied up in litigation with no settlement in sight at the time of construction. Because of the pressing classroom space needs, the architect gave approval to construct the building omitting the north pavilion until the land could be obtained, at which time construction would be completed as planned.

In May 1912, the contract was awarded to low-bidder V. Jobst and Sons for construction of the first stage omitting the north pavilion. The work was completed in four months at a cost of \$86,000 and was open in time

for registration on September 16-17, 1912. The original building was dedicated on May 8 and 9, 1913, with addresses by Samuel Insul, President of Commonwealth Edison of Chicago, and other prominent men in the railway field.

The completion of the first stage of the building left the north end unfinished, with a gable and blank wall randomly sectioned by exposed masonry structural members. World War I delayed work on the second stage until 1921, when the north pavilion was completed to achieve the symmetry of the building. The work was completed by the same contractor who had the original building, this time supervised by the new state architect, James M. White. The total cost of the building as completed was \$168,000.

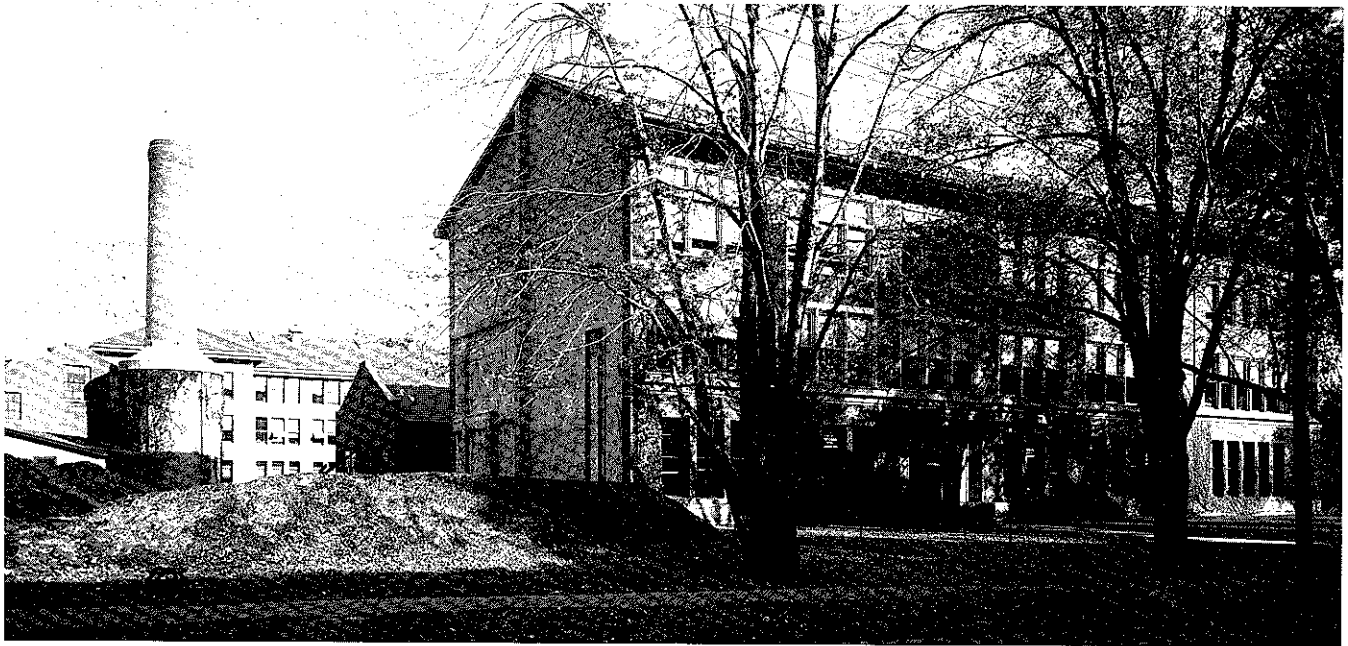

Transportation Building, circa 1912, without the north portion of the building.

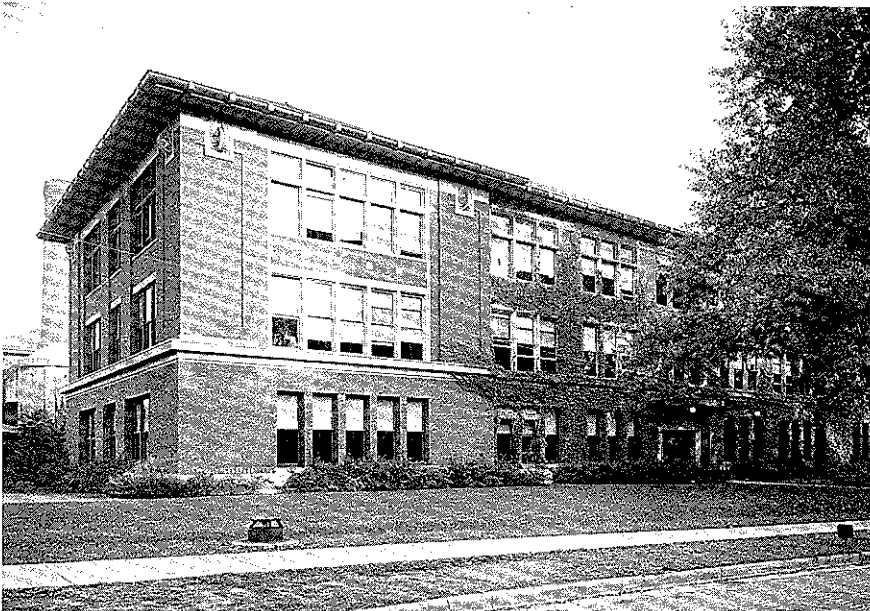

Transportation Building after 1921 when the second (north) stage of the building was completed.

The railway motif of the Transportation Building is seen over the main entrance, in the stone winged locomotive wheels mounted on the fascias, on the top of the newel posts, and in the banister grillwork.

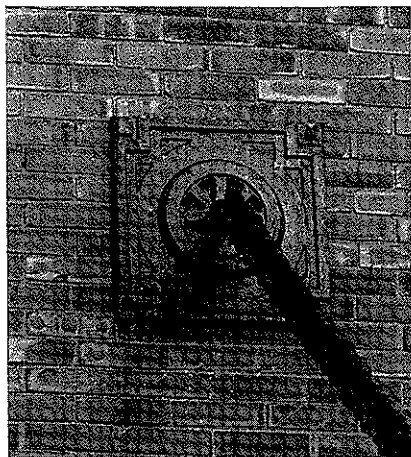

A unique character of the building is the railway motif that is introduced at various places. The main entrance has a wood and iron overhang suspended by two ornamental square-link chains, anchored in the second story wall by two iron anchor plates suggestive of locomotive wheels. The railway motif is repeated on the pavilions in seven winged locomotive wheels carved in stone and mounted on the fascias. Symmetry would suggest that the southeast corner should have an eighth, but early photographs reveal it never existed, although one exists on the northwest corner of the 1921 addition.

The hand rails on the stairway are supported by iron end posts, each topped with a locomotive wheel design. The motif of the banister grillwork is comprised of par-

allelagrams linked with circles, suggesting boxcars on rails. Down through the years, the Transportation Building has maintained its architectural integrity.

In 1912, the first floor was assigned to the Department of Railway Engineering and the second floor to the Department of Mining Engineering. The third floor housed general engineering drawing courses. When the north wing of the building was completed in 1921, the first and second floors of the north wing were assigned to the Department of Mechanical Engineering and the balance of the third floor was assigned to the newly established Department of General Engineering Drawing (1921). The Department of Railway Engineering and its curriculum were disbanded in 1940. When the Mechanical Engineering Building was completed in 1949, its space was taken over by the Department of General Engineering Drawing.

When the Department of Aeronautical Engineering was established in 1943, it was assigned space in the Transportation Building. The remaining offices that were still used by other departments were gradually vacated and by 1959 the entire building was assigned to the Department of Aeronautical Engineering and the Depart-

ment of General Engineering. In 1993, the Department of Aeronautical and Astronautical Engineering moved to Talbot Laboratory, leaving the Transportation Building to be totally occupied by the Department of General Engineering

Originally the General Engineering Drawing Departmental Office was in room 304. When R. P. Hoelscher (joined the department in 1918) became department head, the office was moved to rooms 201 and 201a. Later on they were moved to rooms 113 and 114. In 1959, classroom 112 was taken over as the departmental administrative office for the Department of General Engineering and room 114 was made a conference room with room 113 the department head's office.

Another occupant of the building was the electricians section of the university's Operation and Maintenance Division. It occupied the basement of the original building in 1928. The very south end had been excavated; however, the center section of the original building had only a crawl space. When the electricians moved out in 1963, the basement was completely excavated and an elevator was installed from the basement to the fourth floor. The excavated basement was converted into offices shared by the departments of General Engineering and Aeronautical and Astronautical Engineering.

In the 1960s, a student lounge was established on the second floor in a former classroom. Several other areas also were remodeled in the early 1960s to provide office space. In April 1960, funding was approved for limited remodeling on the south end of the first-floor corridor and for what became several faculty offices at the south end of the second-floor corridor. In July 1960, additional funding was approved in the amount of \$2,610 to partition room 308 and the end of the third floor hall for graduate assistant and faculty offices. In 1993, when the offices of the Department of Aeronautical and Astronautical Engineering moved to Talbot Laboratory, room 308 was converted to a senior design studio and the majority of graduate student offices were moved to the basement.

The fourth floor has a history of its own. When the north wing of the building was built in 1921, it was built on a slab without a basement. However, it did have an attic as did the rest of the original building. The north attic had a stairway to the fourth floor and was finished off into several rooms that were used by the Department of General Engineering Drawing for making blueprints. There was a blueprint machine, washing facilities for the blueprints, and drying racks. One room had a printing press. This was used to print descriptive geometry plates (as problems were called) until 1953, when it was decided to use workbooks.

Part of the fourth floor attic of the original building was floored but unfinished. It was used for storage and a complete woodshop. In the woodshop, wooden models were made and used as teaching aids in the descriptive geometry course. Many of these were made by students in the 1930s under a federal work-study program.

Beginning in 1948, Howard C. Nelson (joined the department in 1945) began a program of designing and making teaching models out of plastic. After World War II, the University of Illinois established several lower division centers, one being in Galesburg, Illinois. When it closed in 1948, the people teaching there were given the opportunity to transfer to the Urbana campus. Nelson taught engineering drawing at Galesburg and decided to come to Urbana and was assigned to the Department of General Engineering Drawing.

After the introduction of workbooks and the elimination of blueprinting, the north wing of the fourth floor was converted into the Atmospheric Research Laboratory in June 1961 under the direction of John E. Pearson (joined the department in 1939). He conducted some of the pioneering research in the measurement of radon gas in the atmosphere. At one time in 1963, plans were drawn up to finish the remainder of the fourth floor by



Between 1921 and 1953, north fourth floor attic rooms were used for making blueprints. In this room the press was used to print descriptive geometry plates.

raising the east half of the roof to a shed-type dormer with an air-sampling platform on top of it. This was never done.

The Atmospheric Science Laboratory (as the Atmospheric Research Lab was later called) was disbanded when Pearson retired in 1974 and the new Department of Atmospheric Sciences was established. Most of the laboratory equipment was transferred to the new department.

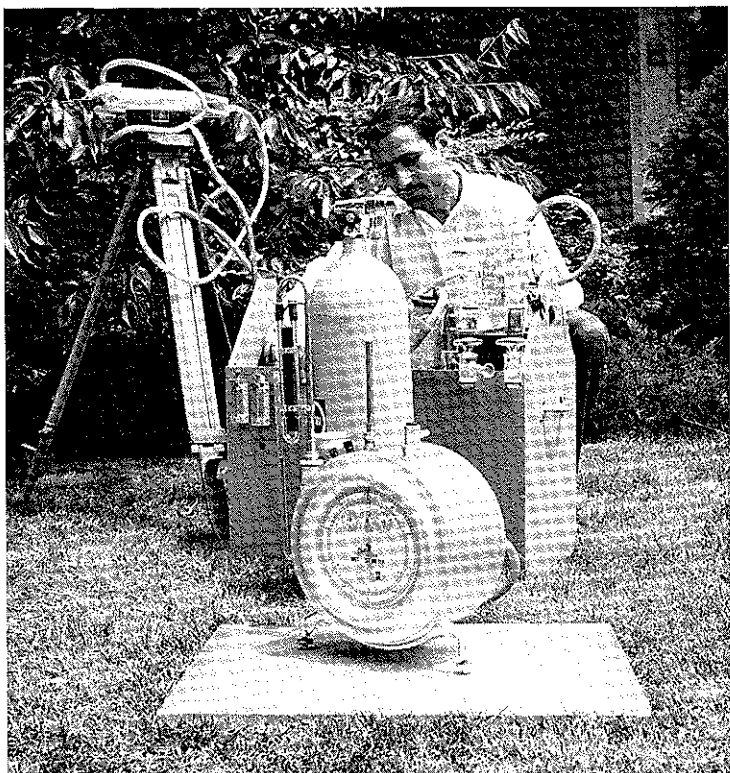

Pioneering work in the measurement of radon gas was done in the department in the 1960s.

The next use for the Atmospheric Science Laboratory space was a computer donated by the Woodward Governor Company of Rockford, Illinois, through the efforts of Louis Wozniak (joined the department in 1966). With the advent of computers, the need for additional space in the building was critical. Attention was again focused on the unfloored and unfinished portions of the central sections of the fourth floor. Approaches were made to obtain funds to finish the space. Even though the elevator went to the fourth floor, the safety codes required two stairway exits. Only the north stairway was in place.

In May 1981, Jerry S. Dobrovolny (joined the department in 1948) was chatting with the director of the Engineering Experiment Station, Ross J. Martin, when Martin indicated that the college was getting some unexpected funds from central administration and he was not sure how to use the funds. Dobrovolny suggested they be used to install a south stairway to the fourth floor of the Transportation Building, which would enable the remainder of the fourth floor to be used for computer laboratories. Martin agreed, and the work proceeded immediately as the funds had to be spent by September 1.

The storage space that had been used by the Department of General Engineering was being eliminated with the remodeling that followed for the computer laboratories. There remained the south part of the fourth floor. However, there was a problem with a 3-foot horizontal beam close to the new entrance making it difficult to use the space efficiently. Dobrovolny met with the structural engineers of the Operations and Maintenance Division and convinced them to redesign the floor structure to carry the load being carried by the 3-foot beam. There was great excitement when the beam was cut and the redesigned floor structure held. The fourth floor is now occupied by several laboratories.

The Harvey H. Jordan Era (1917–53)

Harvey Herbert Jordan received his BS in civil engineering from the University of Maine in 1910. He served as an assistant in civil engineering at the University of Maine during 1910–11. In 1911 he joined the faculty at the University of Illinois to teach general engineering



*Harvey H. Jordan
Department Head, 1921–49*

drawing. When Harry W. Miller left in 1917, Jordan was named acting head of the general engineering drawing program as well as assistant dean of the College of Engineering. In 1921, after an extensive study of the curriculum of the College of Engineering, its faculty felt the importance of general engineering drawing warranted the establishment of the Department of General Engineering Drawing. Jordan was promoted to full professor and named department head; he served in that capacity until September 1949. He continued as an assistant dean of the College of Engineering until 1934 when he was named associate dean of the college and served in that capacity until his retirement in 1953.

After World War I, there was a significant increase in the enrollment of the College of Engineering resulting in an increase in registration in general engineering drawing. From 1918 to 1926, a number of key faculty members who had a significant impact on the development of the Department of General Engineering Drawing and later on the Department of General Engineering joined the faculty. Among these were Randolph P. Hoelscher, Clifford H. Springer, Stanley H. Pierce, Bernt O. Larson, John E. Pearson, and others who stayed only a short time. A similar increase in faculty also occurred after World War II.

The Establishment of the Department of General Engineering, 1953

In 1949, Randolph P. Hoelscher was named head of the Department of General Engineering Drawing. Hoelscher obtained his BS degree in civil engineering in 1912 from Purdue University and his MS in civil engineering from the University of Illinois in 1927. He came to the Department of General Engineering Drawing as an instructor in 1918 after a two-year stint as a structural engineer and physics teacher at Balwin Wallace College. He was promoted to professor in 1931. A more detailed curriculum vitae is included in Chapter 8.



*Randolph P. Hoelscher
Department Head, 1949-59*

In 1953, the name of the department was changed to the Department of General Engineering, with Hoelscher as the head. Administration of the general engineering curriculum was transferred from the Associate Dean's Office to the newly established department. Hoelscher retired in 1959.

At the time, there was considerable discussion as to whether to continue the department and the curriculum in general engineering. After a thorough study, the Luke Report (November 1958) recommended the continuation. The Luke Report is on pages 17-19.

The Next Generation of Department Heads

After Hoelscher announced his retirement in December 1958, Dean William L. Everitt met with the staff of the Department of General Engineering and appointed the following committee to search for a new department

head to serve after Hoelscher's retirement on September 1, 1959. The committee consisted of:

Thomas C. Hartley, General Engineering
Wendell E. Miller, Electrical Engineering
Wayne L. Schick, General Engineering
James R. Tague, chair, General Engineering
Charles E. Taylor, Theoretical and Applied
Mechanics

The committee began meeting in January 1959. It interviewed all of the staff members in the department, as well as other faculty in the college. The last three faculty to be interviewed by the committee were Bernt O. Larson, C. H. Springer, and Jerry S. Dobrovlny. The committee recommended Dobrovlny to be the new department head.

Dobrovlny obtained his BS in general engineering from the University of Illinois in 1943 and his MS in mechanical engineering in 1947. After graduation, he served in the U.S. Army Corps of Engineers for a year and a half, obtaining a medical discharge in December 1944. He joined the Department of General Engineering Drawing in December 1945 as an instructor and was promoted to full professor in 1959. A more detailed curriculum vitae is included in Chapter 8.

In April 1959, Dean Everitt notified Dobrovlny that he had been selected to be department head to be effective September 1, 1959. During the several hours of discussion following, various items were addressed. Among them were the fact that there were no PhDs on the department staff. Staff recruitment was to be a top priority in order to implement the new design sequence



*Jerry S. Dobrovlny
Department Head, 1959-87*

recommended in the Luke Report. With assurances that the dean would support efforts to resolve these problems, Dobrovlny accepted the appointment. He retired in 1987.

Thomas F. Conry was named department head in 1987. Conry obtained his BS in mechanics from Pennsylvania State University in 1963, an MS in mechanical engineering from the University of Wisconsin in 1967, and a PhD in 1970, also from Wisconsin. He joined the Department of General Engineering in 1971 as an assistant professor. He was promoted to full professor in 1987. A more detailed curriculum vitae is included in Chapter 8.



*Thomas F. Conry
Department Head, 1987–*

Related Activities 1959–87

One of the first steps taken by the new department head, Jerry S. Dobrovolny, was to reorganize the committee structure of the department. An Executive Committee, consisting of full professors, was established to assist the department head in developing strategies, promotion criteria, and budget allocations. In addition, an elected advisory committee was established consisting

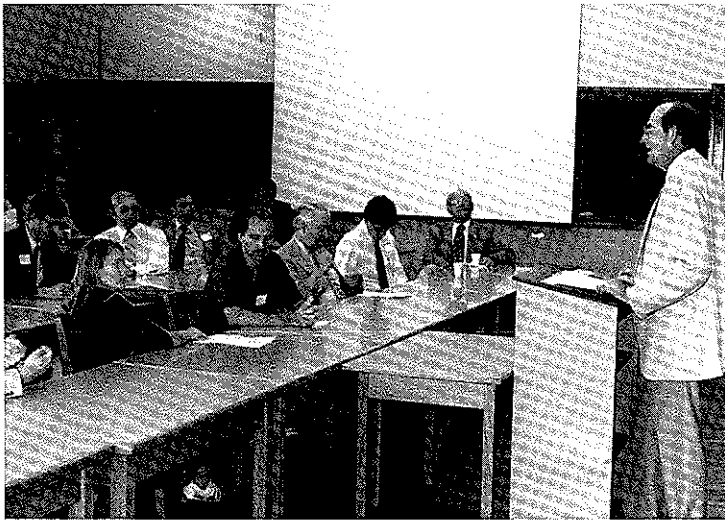

Professor D. C. O'Bryant addresses the participants of a two-week NSF Summer Science Training Program.

of five members, with one member of each of the ranks (instructor to full professor), plus the elected member of the College Policy and Development Committee. All committees of the department reported to the Advisory Committee which met periodically with the department head to discuss general policy and any other topics brought to it by faculty members. In addition, monthly faculty meetings were instituted to discuss committee reports and general policy matters.

Another area that needed attention was that of funded research and grants. All of the faculty were urged to contact various funding agencies that had programs in their areas of expertise. During the 1959–60 academic year, three proposals were sent to the National Science Foundation and two to the Ford Foundation. Both Ford Foundation proposals were funded. One was a grant for full salary for one semester to enable Donald E. Scheck (joined the department in 1954) to attend Purdue University to establish residence in pursuing work on his doctorate. The other Ford Foundation grant was to provide funds to bring Al S. Levens from the University of California at Berkeley to conduct a series of seminars in nomography during the fall semester of 1960–61.

Summer Science Training Program (SSTP)

Of the proposals to the National Science Foundation (NSF) only one was funded. This was to conduct a six-week summer institute in science and engineering for high-ability secondary school students. This program proposed to bring 40 outstanding high school students who had completed their junior year to the campus and acquaint them with the various laboratories in physics, chemistry, and engineering. In addition, there was a mathematics course that met five days a week covering topics in algebra, trigonometry, analytical geometry, and calculus. Jerry S. Dobrovolny was the director of the program. Gordon E. Martin (joined the department in 1953) taught the mathematics course and Bernt O. Larson (joined the department in 1938), as associate director, coordinated the laboratory aspects of the program. After Larson's death in 1974, David C. O'Bryant (joined the department in 1960) became associate director. This program continued to be funded by NSF for 17 years.

This proved to be an excellent program for the College of Engineering to develop a liaison with all the high schools in the state of Illinois. More and more of these talented students did enroll in the College of Engineering in later years, many going on to receive various college and university academic honors.

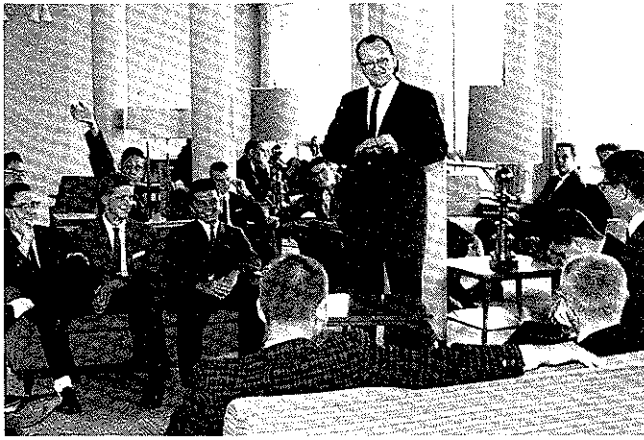

J. S. Dobrovolny welcomes students to the 1962 JETS graduation banquet.

Junior Engineering Technical Society (JETS)

Dean W. L. Everitt felt that the Junior Engineering Technical Society (JETS) in Illinois could be better organized. David R. Reyes-Guerra (joined the department in 1957), a staff member in the Department of General Engineering, accepted the state directorship of JETS in 1961. During his first year (1961–62) as director, he welded the loosely structured organization in the state of Illinois into a highly effective unit with 40 active high school clubs that had a successful convention during the College of Engineering Open House weekend.

The SSTP was again funded for the summer of 1962. There were so many qualified students from high schools applying for the program that it was decided to conduct a two-week version of SSTP sponsored by JETS. This two-week program was so well received that it continues to be held every summer to the date of this writing.

Reyes-Guerra continued to excel in administering the state of Illinois JETS program. He was called on by the national JETS to serve as a consultant. In 1965, he was elected to the National JETS Coordination Board. In 1967, he was chosen to be the national director of JETS and left the University of Illinois. Later in his career, he became the executive secretary of the Accreditation



JETS participants and staff, 1962.

Board of Engineering and Technology (ABET), the body that accredits all engineering and engineering technology curricula.

Following Reyes-Guerra, Robert W. Dalrymple (joined the department in 1965) served as state director in 1967–68. In the summer of 1968, David C. O'Bryant took over as director. In the fall of 1980, Jonathan N. Horner came on board as state coordinator. In 1987, the functions of JETS were transferred to the office of the associate dean for undergraduate studies of the college and David L. Powell was named state director.

Minority Introduction to Engineering (MITE) Program

In the late 1960s there was a great deal of unrest on campuses in the United States. In the summer of 1968 as a last-minute effort to infuse a greater number of black students into the mainstream of college life, Chancellor Jack W. Peltason introduced a program to recruit 600 black students. Little care was taken to select academically qualified students. This program was called the Special Educational Opportunity Program (SEOP).



MITE participants and staff, 1980.

Those students who came to the College of Engineering were particularly ill prepared. Their semester-hour program was reduced and special tutoring and mentoring activities were implemented. It was obvious that for the future if blacks were to succeed in engineering they would have to be better prepared in high school.

Associate Dean Howard L. Wakeland, Dobrovolny, and others decided to organize a two-week summer program for the summer of 1969 for black high school students who had completed their junior year. This program was patterned after the two-week JETS program described above.

To fund this program, Wakeland and Dobrovolny approached a group of industries in the Chicago area in the spring of 1969. Ten thousand dollars was raised for the first Minority Introduction to Engineering (MITE) program. The companies contributing were: Motorola Foundation, Western Electric, Commonwealth Edison, Bell Telephone, Electromotive Division of General Motors, and the Bodine Fund. The program was held in the summer of 1969. It served as a model for other colleges throughout the United States in following years. It is still being conducted as of this writing. The staff involved were the same as those conducting the two-week JETS program.

David C. O'Bryant was named director of the program and served in that capacity for 18 years. He also helped expand the program nationally to 40 programs in his capacity as consultant to the MITE program (Minority Introduction to Engineering).

Technology Audit and Assessment Program

In 1973, when Professor Ronald L. Ruhl (joined the department in 1970) went on leave without pay, he continued to solicit GE 242, Senior Project Design projects in the Rockford, Illinois, area. At that time, computer graphics was coming into play as was computer-aided design (CAD). Department head Dobrovolny suggested the idea of forming a consortium of small companies that could benefit by participation in applied research programs in CAD conducted by the Department of General Engineering.

A preliminary step was to identify the companies that would be classified as small engineering-type companies. Data were obtained from a Dunn & Bradstreet survey that identified 3,000 companies that employed at least five engineering employees, and were located north of interstate 80.

In 1982, the university established the Office for Advanced Engineering Studies in Rockford, Illinois, under the direction of Howard S. Cannon and found that their mutual goals of providing service to the industry in Rockford were compatible with those of the Department of General Engineering. In 1983, the College of Engineering received \$40,000 from the university administration "for a research project relevant to and cooperative with Rockford industry."

A series of conferences was held in Rockford bringing together a number of CEOs of small manufacturing companies from about 1977 to 1986. One of these was with the Small Manufacturers Committee of the Illinois Manufacturers Association.

In the 1982-86 period, Ronald Ruhl also conducted a series of workshops on spreadsheet usage for engineering analysis on PCs using LOTUS 1-2-3. These were conducted through the Office for Advanced Studies in Rockford.

However, as a follow-up to these conferences, on a one-to-one basis, a number of the companies indicated they would be interested in having a technology audit conducted to improve their competitive position. On June 9-10, 1986, a conference was held in Urbana at Jumer's Castle Lodge for 12 chief executive officers who indicated an interest in the Tech Audit program. At that conference, they were made aware of what was going on in the Department of General Engineering, and how the faculty and students might be in a position to assist these companies to improve their production procedures with the use of computer-aided design techniques.

In the fall of 1986, the College of Engineering received a seed-money grant of \$20,000 to pursue the Technology and Assessment Program for small manufacturing companies. The names of the companies that participated in the program are listed in Chapter 5, Grants and Research Funding. After the first year, the program was self-supporting with support from the respective companies.

Chapter 2

Curriculum Development

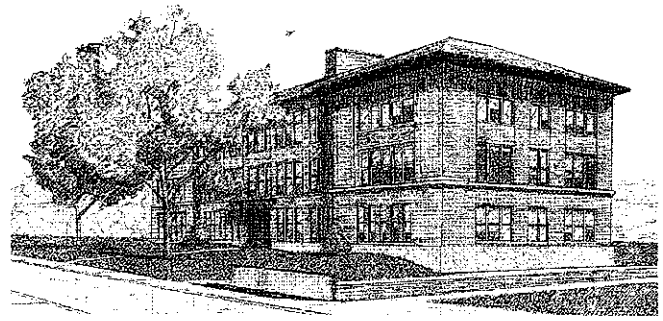

At the founding of the university there were no set curricula. All subjects for the first two years were elective, and for the last two years, suggested programs from other institutions such as Rensselaer Polytechnic Institute, the Massachusetts Institute of Technology, and the University of Michigan were printed in the University Catalogue and Circular. In the 1872–73 University Catalogue and Circular, descriptive material outlining the requirements for these four curricula were approved: mechanical science and art, civil engineering, architecture and fine arts, and mining engineering and metallurgy.

Each student was required to keep a journal during the second and third year vacations in which he was to make entries at least once a week describing travels, observations of engineering work, and participation in engineering activities. These were then reported by the student in his senior year in various courses. The written reports were graded for both content and composition.

All the curricula required a written thesis of original composition and appropriate length to be completed during the latter part of the senior year. The student also was required to present his findings in class and to defend his conclusions. For a more detailed discussion of all curricula requirements at this time see the Baker-King history.

Engineering drawing and descriptive geometry played an important part in the early curricula. This is reaffirmed many times in the Baker-King history of the college. To quote:

“In all courses of study offered by this College, drawing, in its manifold forms and uses, is made a special feature, both in its application and its modes of execution. Wherever possible the classroom instruction was supplemented by the use of plates and models, while the drawing-room work was in a way coordinated with shop practice in that machines designed in the drafting room were actually built in the shop by the students themselves.”

It is important to understand this devotion to the practicum in the general engineering drawing courses, as this continues to be a strong thrust in the present general engineering curriculum.

During the period from 1870 to 1900, in addition to the four original curricula the following also were established: electrical engineering 1890–91, architectural engineering 1891–92, and municipal and sanitary engineering 1891–92. In 1898–99 the semester system went into effect.

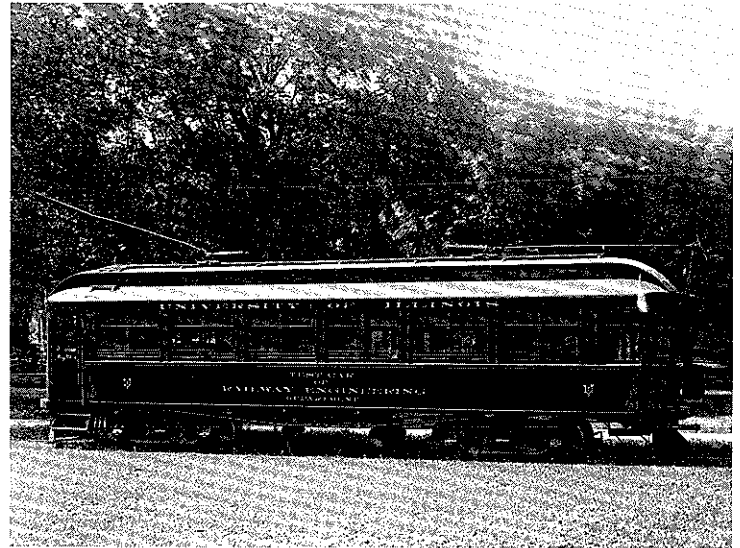

The Transportation Building was built for the Department of Railway Engineering. Test cars like the one shown here situated on tracks in front of Engineering Hall (circa 1908) were furnished with instruments to make continuous records during a run of current used, voltage, speed, and time.

Additional curricula were added from 1900 to 1910: ceramics and ceramic engineering 1905-06; railway engineering 1907-08 with options in civil, electrical, and mechanical. Mining engineering was re-established in 1909.

As a result of all of the curricula that were established in the 20-year period from 1890 to 1910, a study was conducted to evaluate the various programs to determine if they were actually meeting their goals. On March 13, 1911, Dean William F. M. Goss appointed a study committee which was chaired by G. A. Goodenough, Department of Mechanical Engineering. The committee obtained data from other institutions for comparison in such areas as semester hours required for graduation, language and general culture subjects, mathematics, laboratory, drafting, surveying, and other technical courses. The committee was active for two years.

After two years of study, the committee recommended continuing a requirement of 135 semester hours plus 7 hours of military training and physical education. The percentages allotted to various subjects were as follows: language and cultural subjects 25%; mathematics and related courses 45%; and technical laboratory, drafting, surveying, and others, 30%. The thesis requirement was dropped in 1913-14. Various other changes were recommended that resulted in a common freshman year program.

In the early 1900s, several departments required an inspection trip to industry. This was made a college requirement in 1915. The freshman engineering lecture which was initiated in 1909 was retained also.

One of the outcomes of the 1911-13 curriculum study committee was the suggestion by Alfred P. Carman, a professor of physics, and is described in the Baker-King history as follows:

"General Engineering. — A non-specialized engineering curriculum was prepared in a formal communication from Doctor Carman, Professor of Physics, at the time the general revision of the curricula was under consideration during 1911-13. Professor Carman suggested that such a course would prepare men as managers of large undertakings of an industrial or engineering character, for which a specialized curriculum was not required; that such a curriculum would be a good preparation for a general business career; and also that it might be followed by a fifth specialized year of study. The Committee on Revision of Curricula recommended such a curriculum, and the faculty adopted it; but at the request of the President it was not put into effect at that time.

"Under date of May 9, 1919, S. T. Henry, an engineering graduate of 1904 and President of the Allied Machinery Company, in a letter to Dean Charles R. Richards, suggested the advisability of an engineering curriculum that would prepare engineering students to become salesmen in foreign countries.

"Prompted by the suggestions of both Professor Carman and Mr. Henry, and somewhat in line with their recommendations, there was presented for consideration a non-specialized general engineering curriculum leading to the degree of B.S. in General Engineering intended for students who might not wish to undertake a program of training for the more specialized fields of engineering practice, but who, however, might wish to secure fundamental training in the principles of engineering theory in order to ally themselves with industrial and commercial developments in the fields of management, operation, and construction.

"The curriculum approved by the Board of Trustees in 1921 provides a fundamental engineering training with moderate emphasis on design and with some stress given to the business side of engineering and industry through sequences of courses in economics, money and banking, labor problems, etc. The free electives provide a means for the development of any special interests the student may have. The studies in the first two years are not materially different from most of the other curricula in the College of Engineering, the only changes being in the substitution of economics for foreign language and the elimination of shop work with the exception of foundry and one semester of machine shop. In the junior and senior years, the students receive instruction in graphic statics, direct and alternating current, thermodynamics, steam engines, and two years of a language or nontechnical elective and two years of economics.

"The administration of this curriculum has so far been under the direction of the Assistant Dean or Associate Dean of the College of Engineering.

"The successful completion of this program of study, designed to provide young men with a substantial basic knowledge regarding the principles of engineering design and construction and plant organization, management, and operation, has enabled the students to take positions where they could be of immediate service to employers either in the engineering or the business divisions of productive enterprise."

The First Curriculum in General Engineering

The curriculum in general engineering established in 1921 appeared as follows in the 1923-24 Register for that year.
Total hours required for the degree—142

FIRST YEAR

FIRST SEMESTER	Hours	SECOND SEMESTER	Hours
Chem.1a or 1b—Organic Chemistry	3 or 4	Chem.4—Qualitative Analysis	4
G.E.D 1—Elements of Drafting	4	G.E.D.2—Descriptive Geometry	4
Math.2—Advanced Algebra	3	Math.6—Analytical Geometry	5
Math.4—Trigonometry	2	Rhet.2—Rhetoric and Themes	3
Rhet.1—Rhetoric and Themes	3	Phys.Ed.—Gymnasium Practice	1
Phys.Ed.1—Gymnasium Practice	1/2	Mil.2a and 2b, 12a and 12b, 32a and 32b, or 52a and 52b— Military Drill and Theory	1
Hyg.1—Hygiene (Men)	1/2	Engineering Lecture	0
Mil.1a and 1b, 11a and 11b, 21a and 21b, 31a and 31b, 51a and 51b— Military Drill and Theory	1		
Engineering Lecture	0		
Total	17-18	Total	18

SECOND YEAR

Econ.1—Principles of Economics	5	Econ.3—Money, Credit & Banking	3
Math.7—Differential Calculus	5	Math.9—Integral Calculus	3
M.E. 85—Pattern and Foundry Lab.	3	C.E.34—Plain & Topographic Serv.	3
Phys.1a—Physics Lectures	3	Phys.1b—Physics Lectures	2
Phys.1b—Physics Laboratory	2	Phys.3b—Physics Laboratory	2
Mil.3a and 3b, 13a and 13b, 23a and 23b, 33a and 33b, or 53a and 53b— Military Drill and Theory	1	T.&A.M. 20—Analytical Mech.	3
		Mil. 4a and 4b, 14a and 14b, 24a and 24b, 34a and 34b, or 54a and 54b—Mil. Drill and Theory	1
Total	19	Total	17

THIRD YEAR

Econ. 35—Corporations	3	Business Law—Contracts etc.	3
E.E. 11—D. C. Apparatus	3	E.E. 12—A. C. Apparatus	3
E.E. 61—D. C. Laboratory	1	E.E. 62—A. C. Laboratory	1
Language or Approved Elective	4	Language or Approved Elective	4
M.E. 87—Machine and Forge Lab.	3	M.E. 10—Thermodynamics	3
T.&A.M. 25—Resistance of Materials	4	T.&A.M. 26—Analytical Mech. and Hydraulics	4
Total	18	Total	18

FOURTH YEAR

Chem.7—Metallurgy of Iron and Steel	3	Math.23—Averages and Math. in Investments or	
Econ.41—Labor Problems or		Geol.43—Engineering Geology	3
Econ.29—Foreign Commerce and Commercial Policies	3	Econ.42—Labor Organizations and Employer Associations or	
Language or Approved Elective	4	Econ.43—Personnel Administration	3
M.E.3—Steam Eng.	3	M.E.64—Power Measurements	3
C.E.88—Stresses in Structures	4	Language or Approved Elective	4
C.E. 99—Inspection Trip	0	C.E.90—Structural Design	4
Total	17	Total	17

The first curriculum in general engineering, as shown on page 13, can be broken down as follows:

Mathematics, Chemistry & Physics	38 hrs
Graphics	8 hrs
Rhetoric	6 hrs
Economics & Law	20 hrs
Language or Electives	16 hrs
Heat Power	9 hrs
Theoretical and Applied Mechanics	11 hrs
Military and Physical Education	6 hrs
Machine Shop, Foundry	6 hrs
Survey and Geology	6 hrs
Electrical Engineering	8 hrs
Structural Design	8 hrs
	142 hrs

The liberal allowance of 20 hours in economics and law, as well as the 16 hours of electives demonstrates the strong orientation to management. By 1940 the design requirements were increased to 16 hours. Students also were able to substitute the machine design sequence for the structural design sequence. One of the major changes in the curriculum occurred after World War II, when there was a large influx of veterans who by and large were much older and were more mature than the usual college student.

Secondary Fields

In 1948, Dobrovolny was approached by a group of these veterans with the request they be able to substitute groups of courses for some of the required economics courses. After a series of meetings, the "secondary field of concentration" evolved. However, the basic technical content of the curriculum was not altered.

It is recalled that when this idea was presented to the senior adviser Clifford H. Springer (joined the department in 1924), he did not think Associate Dean Harvey H. Jordan (who administered the curriculum) would approve it. Dobrovolny insisted that the proposal be discussed with Jordan, and a meeting was arranged. Much to Springer's surprise, Jordan was impressed with the proposal and thus the secondary field of concentration options were activated in 1949 on a petition basis. The initial options were management, marketing, technical writing, and mining. Other fields were possible upon a petition-approval procedure whereby the group of courses had to meet a specific career goal. The formal approval of the secondary fields by the College Policy and Development Committee was on January 13, 1954, and appeared in the 1954-55 university catalogue.

At that time one of the popular fields was law. The College of Law required 90 hours of college work before the student could be admitted. This enabled students in general engineering to be accepted into law school during their senior year and to take law courses that would count toward both a law degree and an engineering degree. When the College of Law changed its requirements for entrance to a BS in 1964, students in general engineering could no longer take the law courses. However, a significant number took a pre-law secondary field and then went on to law school. At the time of this writing, there are probably at least a hundred general engineering graduates who obtained law degrees.

Another option was accounting. The student could take enough accounting courses to permit him to take the CPA examination during the senior year, as well as the Engineer-In-Training (EIT) examination.

Through the years, the management option has been the most popular. A large number of graduates in this field have gone on to obtain Master of Business Administration (MBA) degrees. Many obtained the MBA degree while they were working as engineers.

Other fields that have been approved on a petition basis are: philosophy (pre-ministry), pre-med, electrical engineering, biomedical, geology, thermodynamics, internal combustion engines, control systems, computer science, forestry, and education.

Curriculum Studies and Evaluations, 1951-59

In 1951, the College Policy and Development (CP&D) Committee established a subcommittee to analyze curricula at other institutions labeled general, industrial, or administrative engineering. Jerry S. Dobrovolny was named chair of the committee with mechanical engineering professor Allan G. Friederich as the other member. The curricula selected for analysis were taken from the Engineers' Council for Professional Development (ECPD) accredited list; they included 6 general, 3 administrative, 1 management, and 10 industrial curricula, for a total of 20 including the general and industrial engineering curricula at the university.

The conclusions of the report stated there was only a negligible amount of overlapping between the general engineering and the industrial engineering curricula. The report recommended that no changes be made in the general engineering curriculum because it was a sound curriculum that required a sequence of courses not available in other curricula offered at the university. The report was unanimously accepted at the March 18, 1952, meeting of the College Policy and Development Committee of the College of Engineering.

From 1953 to 1959, many changes were occurring nationally in engineering education. The American Society for Engineering Education published its Grinter

Report in 1954, which stated that the trend was for more mathematical analysis in engineering design, more research in the physical sciences, and more social sciences and humanities requirements.

With the establishment of the Department of General Engineering in 1953, which incorporated the former Department of General Engineering Drawing, the administration of the curriculum in general engineering was transferred from the Associate Dean's Office, as were other service courses such as history of engineering, engineering law, and engineering economics. R. P. Hoelscher continued as head of the department. In his 1952-53 annual report of the Department of General Engineering Drawing, he identified some of the needs for future years:

"(a) Providing several new courses which must be taught and administered by the Department, thus giving a little greater variety and interest in our course offerings.

(b) It will require a broader outlook over the various fields of engineering practice on the part of staff members than formerly the case."

Prior to September 1953, the primary courses taught by the staff were in graphics. The largest enrollments were in the freshman courses in engineering drawing and descriptive geometry. The course offerings in 1952-53 were:

- GE 101 — Elements of Drawing
- GE 102 — Descriptive Geometry
- GE 103 — Aircraft Drafting and Lofting
- GE 104 — Advanced Drawing
- GE 105 — Elements of Drawing (for aircraft maintenance)
- GE 106 — Elements of Drawing (for chemical engineers)
- GE 107 — Architectural Projection (for architects)
- GE 108 — Architectural Projection (for architects)
- GE 205 — Applied Descriptive Geometry in Geological Problems
- GE 210 — Industrial Production Illustrations
- GE 212 — Graphical Communications

It became apparent that changes would have to be made to maintain the integrity of the department, particularly in faculty research and developing new courses for the general engineering students. There were pressures in the College of Engineering to reduce the number of hours devoted to engineering drawing and descriptive geometry.

In 1954, GE 101 and GE 102 were reduced from 4 to 3 semester hours with the Department of Electrical Engineering dropping GE 102. Two new sophomore courses were developed for students: in mechanical engineering, GE 112 (2 hours) Advanced Drafting for

Mechanical Engineers, and for civil engineering, GE 111 (2 hours) Advanced Drafting for Civil Engineers. These were taught beginning in the fall of 1954.

On May 9 and 10, 1955, the college underwent an Engineers' Council for Professional Development (ECPD) accreditation inspection. This was the first ECPD evaluation of the general engineering curriculum since it was transferred to the Department of General Engineering in 1953. The curriculum was fully accredited for the maximum term of six years.

The report made several comments and recommendations—among them, a statement about design. The following are excerpts:

"An adequate design sequence in C.E. or in M.E. covers the same courses taken by most majors in those fields. Graduates are eligible to take the E.I.T. examinations given by the State Board.

"It appears that the great weakness of the curriculum as such is that the students are 'farmed out' for all of the undergraduate work.

"I should like to suggest that a senior course of one semester in creative design might strengthen this weakness. It would be handled on a project basis and would give the staff a livelier goal and the students a keener insight into engineering activity even though they later accepted positions in engineering sales or administration."

This was the first introduction of the concept that general engineering would develop its own design program. Dan Pletta from the Virginia Polytechnic Institute was the inspector.

In 1955-56, a follow-up of the ECPD report suggesting more contact with the general engineering students in the junior and senior years, GE 220 (3 hours) History of Engineering taught by Jerry S. Dobrovoly, was made a required social sciences/humanities stem requirement in the junior year. GE 291 (0 hours) Senior Seminar was required in the last semester of the senior year; GE 292 (3 hours) Engineering Law, also was required in the first semester of the senior year.

Several new elective courses at the advanced 300-level were also offered: GE 313 (2 hours) Advanced Methods of Engineering Graphical Computation, and GE 393 (1-4 hours), Special Problems.

During the year, three members of the faculty were admitted to the Graduate College: C. H. Springer, J. S. Dobrovoly, and Huo-Hsi Pan (joined the department in 1954).

In 1956–57, a secondary field of concentration in technical journalism was implemented with support of the Sperry Gyroscope Division of Sperry Rand Corp. In 1957–58, GE 330 (2 hours or 1/2 unit), Industrial Standardization, was developed and approved by the College Policy and Development Committee. GE 304 (3 or 4 hours or 1 unit) was cross-listed with English 304, Professional Expression. These were elective courses not only for general engineering students, but all students in the College of Engineering.

In his Annual Report of June 1958, Department Head R. P. Hoelscher writes about the need for the staff to have more contact with general engineering students.

“We still need senior design courses that will lead to professional practice and, if possible, into an area of graduate study for both students and staff.”

He goes on to state:

“Develop design courses within the department which will cut across all ‘old line’ engineering fields and meet the needs of General Engineering to better advantage than the present arrangement.”

In a memorandum dated June 5, 1958, Dean W. L. Everitt appointed a committee “to make a careful study of the objectives and desirable areas of development for the department.” The problems he asked the committee to consider were:

1. What changes in emphasis are indicated
 - a. For the immediate future
 - b. During the next decade
2. How can we best develop the members of the department in their professional careers? Would more joint appointments with other departments be desirable?
3. How can we make it attractive for able young men to join the department?
4. What are the possibilities for development of research and graduate programs and how may these areas be expanded effectively?
5. Should there be more development of additional outlets for professional interest such as the present ones in engineering law, report writing and engineering history?
6. What are the responsibilities of the department to the students in the curriculum in General Engineering?”

The committee was to report by December 1, 1958. The members were:

Don U. Deere, Civil Engineering
Jerry S. Dobrovolny, General Engineering
Bernt O. Larson, General Engineering
Edwin D. Luke, chair, Mechanical Engineering
Gordon E. Martin, General Engineering
Wendell E. Miller, Electrical Engineering
Clifford H. Springer, General Engineering

The committee first met on September 25, 1958. In its deliberations the committee agreed to gather data about the curriculum and its graduates. Several ministudies were made. One was on the distribution of then current general engineering students with respect to year in school, type of design being taken, and secondary field options of study. The enrollment in the design sequence ran over two-to-one in machine design as opposed to civil engineering design. About 80% were in the management or sales options in their choice of secondary fields. The survey covered the graduates from December 1955 through March 1958.

Another study summarized the employment of general engineering graduates for the period from February 1956 through August 1958. These data included the names of companies hiring general engineering graduates, the salary averages compared with those of other curricula, and the percentages employed. The concluding statement of this study is as follows:

“From these statistics several things are apparent. It is obvious that General Engineers are employed by a wide variety of companies so that their usefulness is not limited to any one area. A very high percentage of the graduates accept employment before the end of their last semester. The salary range for General Engineers is slightly lower than the average for the college in most cases, but this may be due to the fact that many are interested in sales and management instead of the highly technical fields. Statistics show that salesmen surpass engineers in earning power after they have been out of college for several years.

“The number of companies requesting General Engineers for interviews is large and is growing continually. Many interviewers do not know about our General Engineering curriculum, but as they become acquainted they are adding it to their list. In the future this record should look even better than it does now.”

The committee submitted its report on November 7, 1958. It was known as the Luke Report, and was perhaps the most important document in determining not only the future of the Department of General Engineering, but its very continuation. At that time there were many forces in the College of Engineering who would have just as soon seen the department eliminated. The writer feels that the report is so important that it is being included in its entirety in this history of the Department of General Engineering.

Luke Report November 7, 1958

*Report of the Committee for the Study of
General Engineering at the University of Illinois*

I. General.

The committee met once each week, beginning September 25, in room 142 M.E. Building for a period of two hours each meeting. Vital statistics necessary to promote and further committee discussion were gathered by individual members between meetings and as the need for such data became apparent.

II. The General Engineering Department.

The first point that was considered by the committee was whether or not the department should continue in existence. After due deliberation, it was unanimously decided that there was a definite need for such a curriculum in a university the size of the University of Illinois. This need is indicated by specific requests from industrial concerns to interview students in the General Engineering curriculum as well as by the interest shown by the students as evidenced by the increasing enrollments in the curriculum. With an undergraduate enrollment of 237 students as of September 14, 1958, the curriculum of this Department ranks sixth in the thirteen curricula administered either partially or entirely by the College of Engineering. The department currently offers 11 courses for undergraduates (100-courses), 8 courses for advanced undergraduates (200-courses), and 4 courses for advanced undergraduates and graduates (300-courses). There are 26 full-time members of the staff and 6 part-time graduate assistants. The staff holding memberships in 32 individual technical societies and fraternities and has participated in a great

number of papers and other publications. Further statistics regarding the staff are as follows:

Rank Distribution		Degrees Held*	
Professor	6	Doctor	1
Associate Professor	4	Master	16
Assistant Professor	5	Bachelor	9
Instructor	11		
Graduate Assistant	6	*Full-time staff	

Teaching Experience		Industrial Experience	
20 years or over	6	20 years or over	2
10-20 years	7	10-20 years	3
5-10 years	3	5-10 years	10
0-5 years	10	0-5 years	11

III. Recommendations for Staff Development.

A. In discussing various problems with individual staff members it has become apparent that certain operational practices need revision so that a greater professional achievement will be possible by the staff members. The following recommendations are made in view of these discussions.

1. Teaching loads should be investigated to bring them more in line with those in other departments in the college.
2. The average salaries by rank are the lowest in the college, the greatest discrepancy being in the ranks with tenure. This inequality should be resolved.
3. Time should be allotted from the teaching load for individuals to carry on research that will be of help in developing the individual professionally as well as developing research projects for the department.

B. Most of the staff members have been maintaining their professional competency on their own initiative by carrying on research or by working during the summer as well as during the academic year in their various specialized fields of interest. Some have worked in engineering capacities for other state agencies, for industry, and for engineering firms, others have done consulting work.

IV. The Curriculum.

There are eight accredited curricula in General Engineering in the United States. As of September 1957 the University of Illinois ranked fourth among these on a basis of enrollment. Of the eight schools only one, the University of California, offers a sizable graduate program in General Engineering.

The curriculum in the University of Illinois included 144 hours of study, including Physical Education and Military Science. It shares a common freshman year with all other engineering curricula. In the third and fourth years the student may choose between the Structural Design Option and the Machine Design Option. Within each option the student is required to select courses from a chosen Field of Concentration such as:

- Engineering Administration
- Engineering Publications
- Engineering Geology
- Engineering Sales
- Engineering Law

The first students were graduated from the General Engineering curriculum in 1923. Since that date, including 1958, the curriculum has graduated 662 students.

V. Achievements of General Engineering Graduates.

Vital statistics for the graduates of the years 1955-56, 1956-57 and 1957-58 were obtained from the Placement Division of the College of Engineering and were studied in detail by the committee with the results as summarized below.

A. The demand for General Engineering graduates by industry was quite normal, with graduates widely distributed among the various types of industrial firms.

B. The employment records of the graduates were very good. Other than for those who were taken into service with the Armed Forces, there were very few of the graduates who were not immediately employed; of the latter, most could be traced to self-employment and other reasons for refusing industrial positions.

C. Although the high salary for a graduate was generally below that of the graduates of other curricula, the average salary of General Engineering graduates compared very favorably with the average salary of graduates from all curricula; the latter comparison was felt to be most reasonable as the high-salary average is generally affected by the salary scales of certain specialized industries. (In the Placement Office five and ten-year follow-up studies showed that General Engineering graduates were always first, second or third in salary.)

VI. Changes in Emphasis in the General Engineering Curriculum.

A. The committee feels that there should be no major changes in emphasis in the curriculum in the immediate future. This is construed to mean a two-year period beginning September 1, 1959, during which a new Head of Department is becoming oriented in his position. Following this period there are a number of changes in emphasis which are recommended for investigation as cited in part B. below.

B. The following changes in emphasis are recommended for the next decade:

1. At the present time about 80% of the General Engineering students are preparing for work in either engineering administration or engineering sales. As these interests lead the graduates into work in, or cutting across, all the specialized fields of engineering, it is believed that limiting their design training to only one of the fields (Structural Design or Machine Design) is not entirely satisfactory. It is believed that a sequence of advanced design courses synthesizing the principles of the accepted fields of engineering should be developed as soon as possible. This would also greatly increase the interest and effectiveness of the staff by making it possible for them to teach advanced courses. The development of such a sequence would lead to graduate courses and research work in that area. It is believed that extensive investigation and study should precede the establishment of the courses and that the earliest date at which they could be offered would be two or three years after they have been authorized.
2. In view of the numerous problems which cross the fields of professional disciplines in Engineering and Meteorology (i.e. Hydrology, Atmospheric Contamination, Loads on Structures, Heating and Cooling Loads, etc.) and since members of the department already have professional training in both areas, attention should be given to the development of a series of courses in meteorology and its application to engineering problems. These courses would be available to all qualified students.
3. It is believed that considerable thought should be given to the possible adoption of a five-year curriculum. This could possibly take the form of two years of pre-engineering followed by three years of technical work within the department. The development of a 5-year dual-degree program in Engineering Geology presents such an opportunity.

4. The opportunities afforded the graduates of the department should be considerably enhanced by the attainment of advanced degrees. Since the development of graduate courses and staff represents a large undertaking, the department should aim toward the Master's degree as a maximum attainment for the next decade. It would be well to limit the initial efforts to a specific field of concentration; Meteorology seems to be an ideal choice of field for this first phase.

VII. Additional Outlets for the Staff.

There are several outlets which can improve the morale and the efficiency of the staff. Although some of these act primarily to relieve the boredom of teaching a fixed group of undergraduate courses, others aid in the professional development of the individual and the department as well.

A. A concentrated effort should be made to develop new courses in fields of interest which seem to fall naturally into the scope of General Engineering. The three fields which come quickly to mind are those of Sales Engineering, Engineering Economics, and Engineering Statistics.

B. The development of research in the department is not only highly desirable but also necessary and urgent. Several staff members have already demonstrated research ability by engaging in extra-curricular activity with other agencies not under departmental control. It is easy to say that the staff should be encouraged to do research, but more than words are necessary. Some policy should be established to implement these words. The present teaching load, together with several committee assignments leaves little time for thought, let alone action. Therefore, the interested staff members should be allowed time in their work loads for the necessary research, study and reading which could result in initiation of research and development of research proposals.

As well as having present members bring research into the department, perhaps the goal could be further accomplished by bringing into the department staff members on research appointments who are already doing research or have problems for which approval can readily be secured.

C. The development of a graduate program of study as outlined in VI-B-4 should provide an extremely important outlet for the energies of the staff.

VIII. Recruitment of Staff.

It goes without saying that increased salary scales and opportunity for advancement in rank play a large part in the recruitment and maintenance of a staff. Office and classroom facilities as well as other environmental factors loom almost as large. These are local problems which any Department Head expects to cope with continuously. There are, however, other factors involved which will be discussed below in more detail.

A. For the recruitment of staff, only the University of California can be depended upon for graduates with advanced degrees in General Engineering. This is not serious since experience indicates that staff members graduating from other fields of engineering such as Civil, Mechanical, Electrical, etc., perform very adequately in General Engineering.

B. The concept of split-appointments has been advanced both as an inducement and as a broadening factor for the individual. Extreme caution is urged in the application of this concept. It is true that many individuals may look with favor on such arrangements, and these individuals should be encouraged, but in many other cases it proves very undesirable. Split-appointments should be purely voluntary and created only with the specific consent of the individual; further, the individual should receive ample recognition for his efforts. Too often an individual on split-appointment between two departments becomes an "orphan" in one or both departments, especially if he is split 1/2 - 1/2. A preferable arrangement would be a 1/3 - 2/3 split, with the individual assured of the opportunity of instructing upper-level courses in at least a substantial portion of his assignment.

C. The development of advanced courses and of graduate study should furnish an inducement for the recruitment and development of a staff. (These phases have been discussed in prior sections of this report.)

D. The opportunity to perform established research (already discussed) should be attractive to many individuals, particularly younger men attempting to establish and broaden themselves in the academic field.

Respectfully submitted by the Committee

The Luke Report was used for the guidance of the new department head to be appointed following Hoelscher's retirement on September 1, 1959. One of the most important recommendations appears in Section VI, B, 1:

"It is believed that a sequence of advanced design courses synthesizing the principles of the accepted fields of engineering should be developed as soon as possible."

It further states:

"The development of such a sequence would lead to graduate courses and research work in that area."

In Section VI, B, 4, it recommends:

"The department should aim toward the Master's degree as a maximum attainment for the next decade."

The implementations of these recommendations will be discussed later.

General Engineering Design Courses

The suggestion of developing a project design course for general engineering students was first recommended in the 1955 ECPD report. Hoelscher mentions the need in his June 1956 Annual Report. In his June 1958 Annual Report he again identifies the need for more direct contact with the general engineering students by developing a series of general engineering design courses.

Following the recommendations of the November 7, 1958, Luke Report, Hoelscher appointed a committee chaired by C. H. Springer to develop a sequence of design courses for the general engineering curriculum. This was in the spring of 1959. The committee decided that to better meet the needs of the general engineering graduates, a survey of past graduates would be helpful in determining the content of the courses.

This survey was conducted during the summer of 1959 and was sent to all graduates since 1922 for whom addresses were available. The questionnaire was sent out with Vol. 1, No. 1 of the *General Engineering Newsletter* dated May 1959. There was a 40% response to the questionnaire. The largest number of the graduates were employed in manufacturing. Over 50% were in management. The next highest group, about 15%, were in sales. A significant number had gone on to graduate school seeking the MS and the PhD in engineering. Another significant number went on to obtain a law degree and others the MBA degree.

Questions were asked concerning curriculum content in the areas of: basic science, mathematics, engineering science, design, commerce, and the social sciences-humanities. The opinions were somewhat divided: about 70% felt coverage in basic science and mathematics was acceptable; about 50% felt coverage in engineering science and design was adequate. In the above areas, 20 to 30% felt there should be more coverage. In the areas of commerce, social sciences, and the humanities, over 50% felt there should be greater coverage.

A number of comments were made about design. Some of those that had taken the machine design sequence indicated they would have liked an exposure to structures; and some who had taken the structures sequence indicated a need for some machine design. When asked what curriculum they would now enroll in if they were to do it over again, over 90% responded that it would still be general engineering.

The responses were analyzed by the decades in which the graduates obtained their degree in general engineering. These were plotted on charts as shown in Figures 1 and 2.

The data from the survey further supported the needs for an integrated engineering design sequence in the general engineering curriculum. On September 9, 1959, the design committee submitted to the general engineering faculty tentative course outlines for four courses and identified two others for the senior year. The four courses were then submitted to the College Policy and Development Committee (CP&D) on September 29, 1959. There were:

- GE 221 Introduction to Design
- GE 231 Engineering Analysis I
- GE 232 Engineering Analysis II
- GE 288 Economic Aspects of Engineering

A subcommittee of CP&D was appointed to study the entire six-course design proposal. The data from the survey of graduates were presented to the subcommittee. After many meetings, the proposed program was approved. The specific courses listed above were also approved and during the spring semester of 1960, GE 221 was taught.

The entire design sequence was approved by CP&D on April 11, 1961, and was implemented in the fall of 1961 with GE 231 and GE 288 being taught the first semester and GE 232 the second semester. The two senior design courses were taught in the 1962-63 academic year: GE 241, Component Design, the first semester, and GE 242, Project Design, the second semester.

The new curriculum, adopted in 1961, with a list of the "suggested fields of concentration," is outlined on page 23:

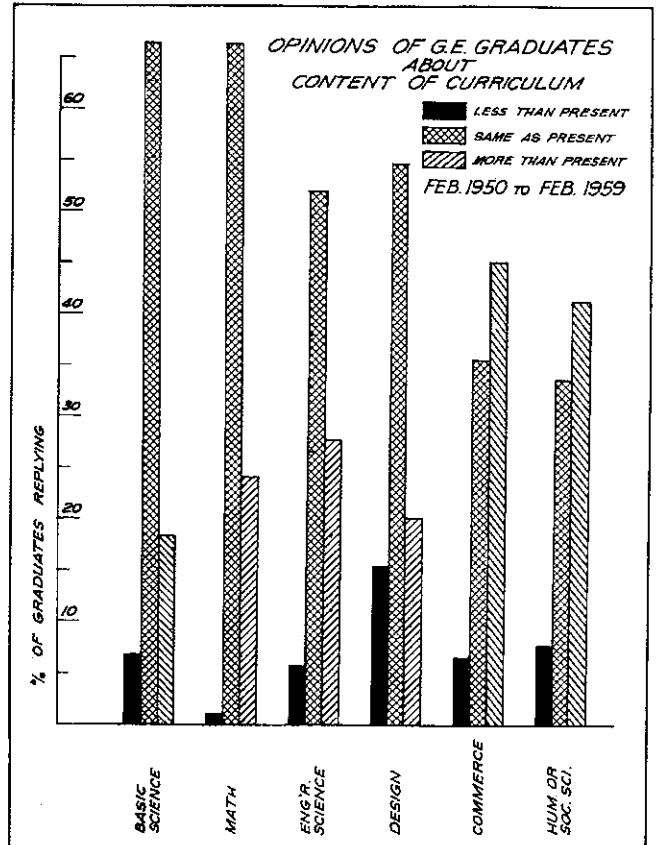
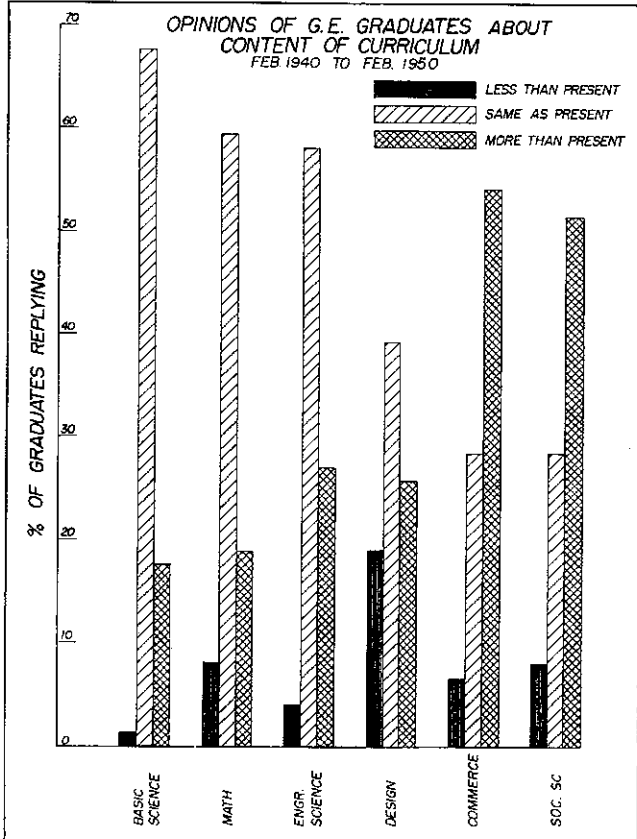
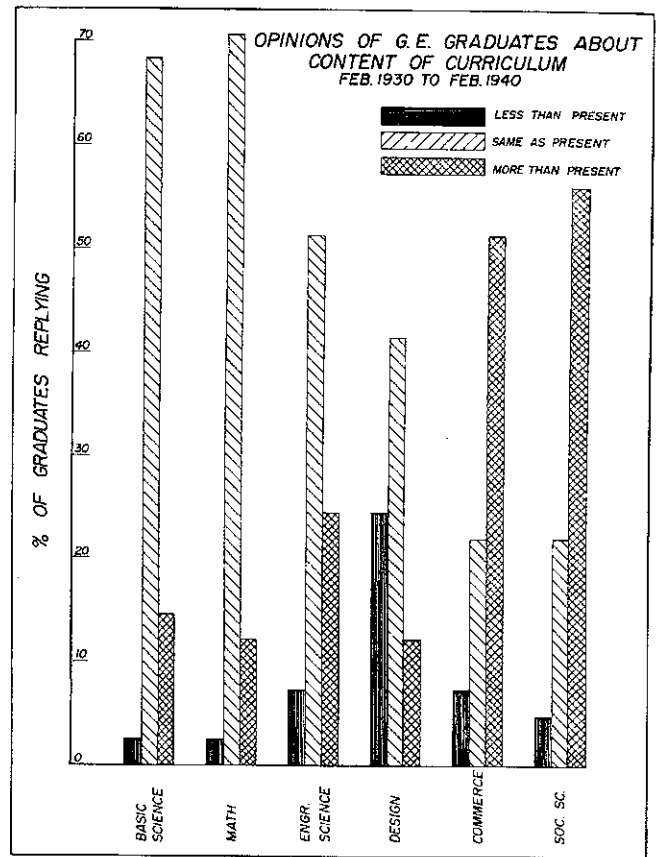
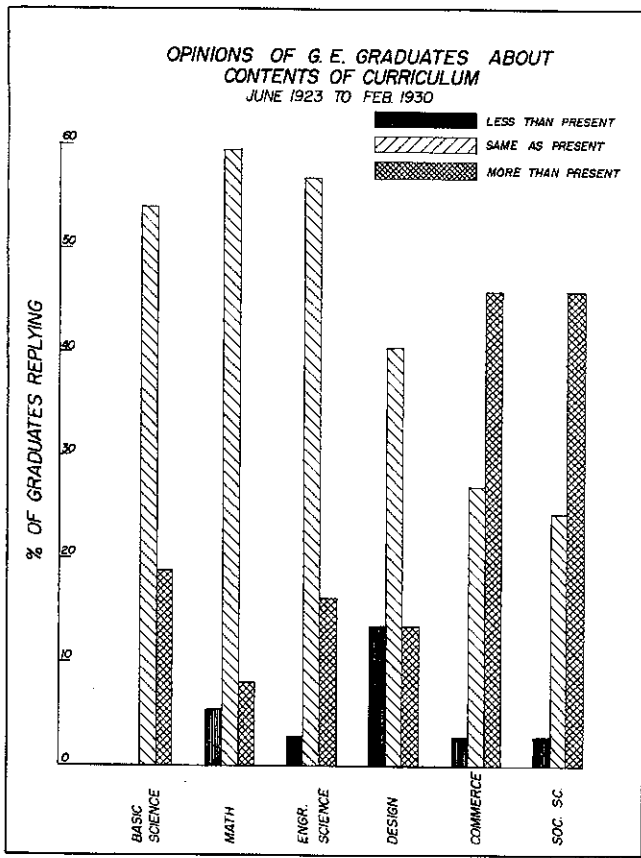

Figure 1

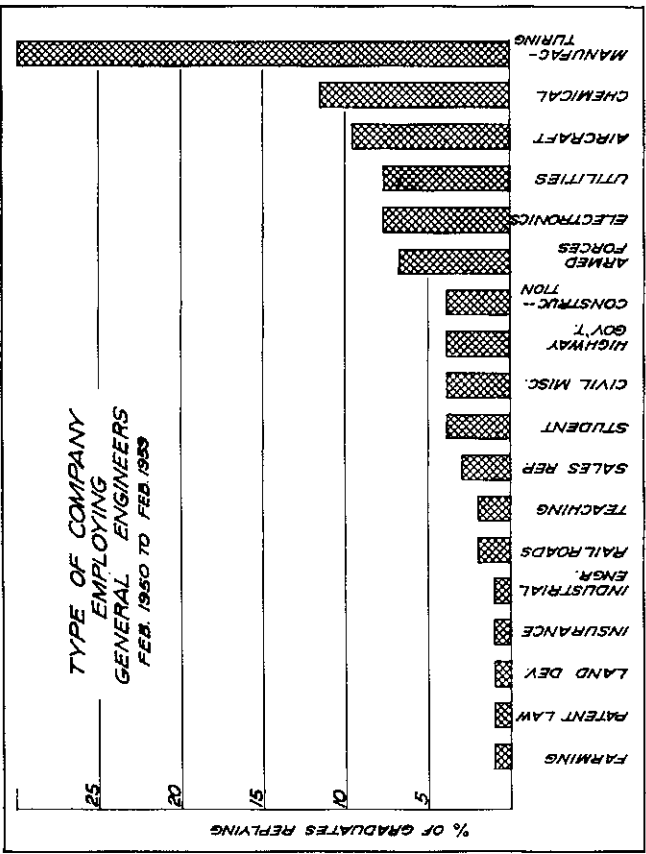
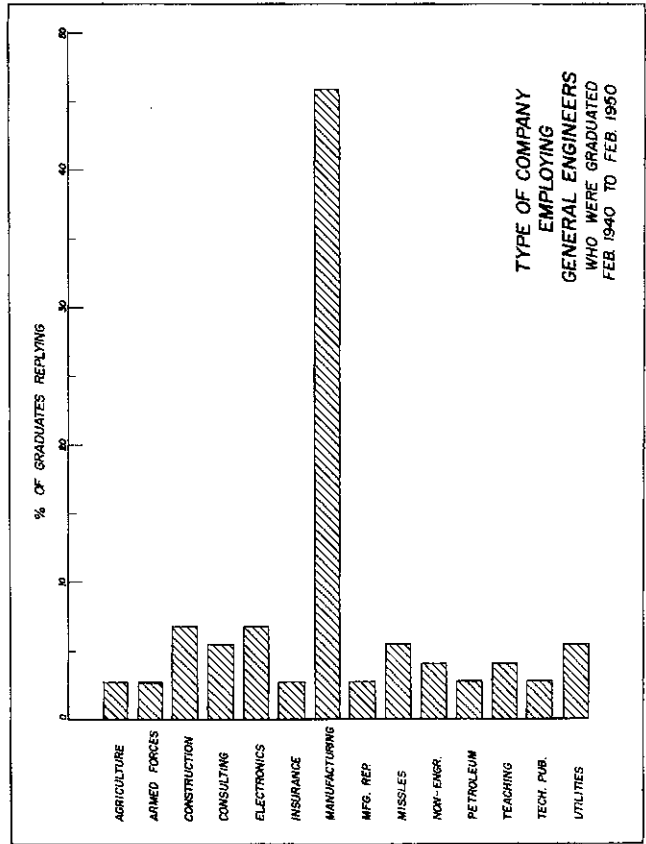
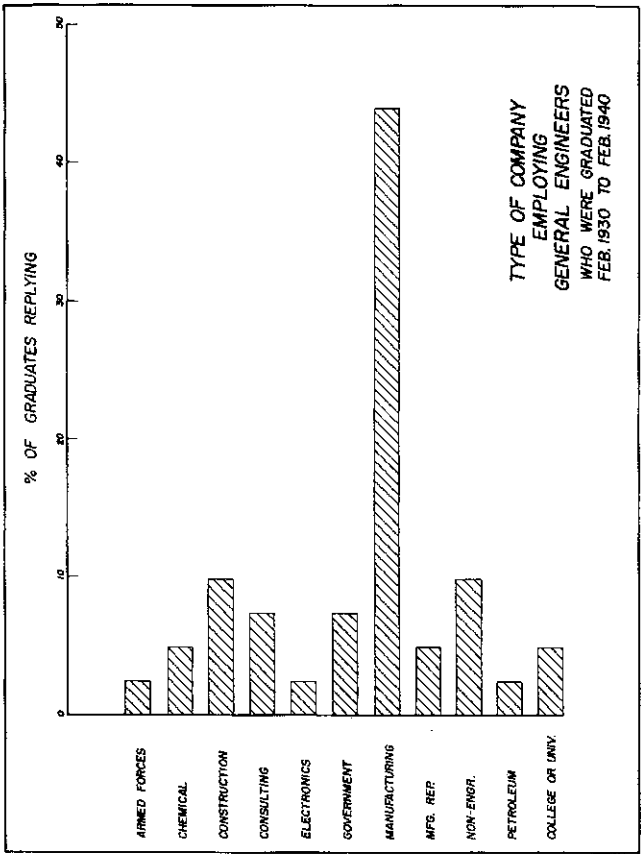
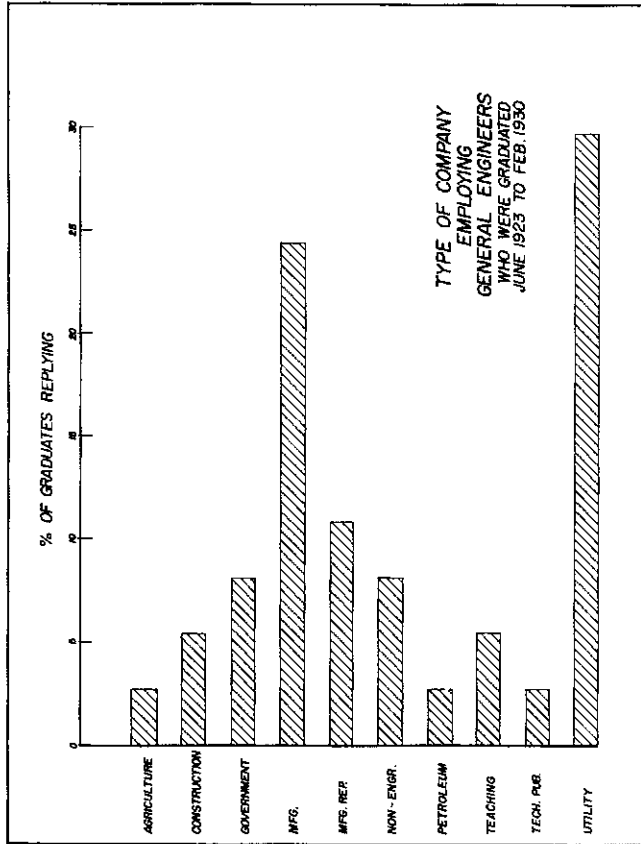

Figure 2

New Curriculum, 1961

Total credit hours required for the degree—127

FIRST YEAR

FIRST SEMESTER	HOURS	SECOND SEMESTER	HOURS
Chem. 101 — General Chemistry	4	G.E. 104 — Engineering Project Design	
Eng. 100 — Engineering Lecture	0	Methodology	3
G.E. 103 — Engineering Graphics I	3	Math. 130 — Calculus and Analytic	
Math 120 — Calculus and Analytic		Geometry	5
Geometry	5	PhyCs. 106 — General Physics (Mechanics)	4
Humanities or social sciences elective	3	Rhet. 105 — Principles of Composition	4
Total	15	Total	16

SECOND YEAR

C.S. 101 — Introduction to Computers for Application to Engineering and Physical Science	3	Math 345 — Differential Equations and Orthogonal Functions	3
Econ. 101 — Introduction to Economics	4	PhyCs. 108 — General Physics (Wave Mo- tion, Sound, Light, and Modern Physics)	4
Math 240 — Calculus of Several Variables	3	T.A.M. 212 — Engineering Mechanics II (Dynamics)	3
PhyCs. 107 — General Physics (Heat, Electricity, and Magnetism)	4	T.A.M. 221 — Elementary Mechanics of Deformable Bodies	3
T.A.M. 150 — Analytical Mechanics (Statics)	2	Humanities or social sciences elective	3
Total	16	Total	16

THIRD YEAR

G.E. 221 — Introduction to General Engineering Design	3	E.E. 244 — Electrical Engineering Laboratory I	2
G.E. 222 — Analysis of Dynamic Systems	3	E.E. 260 — Networks I	3
G.E. 288 — Economic Analysis for Engineering Decision Making	3	G.E. 232 — Engineering Analysis	4
M.E. 209 — Thermodynamics and Heat Transfer	3	Secondary field elective	3
Secondary field elective	3	Humanities or social sciences elective	2
		Free elective	3
Total	15	Total	17

FOURTH YEAR

G.E. 241 — Component Design	4	G.E. 242 — Project Design	3
G.E. 292 — Engineering Law	3	G.E. 291 — General Engineering Seminar	0
T.A.M. 235 — Fluid Mechanics	4	Technical elective	3
Secondary field elective	3	Secondary field elective	3
Humanities or social sciences elective	3	Humanities or social sciences elective	3
		Free elective	3
Total	17	Total	15

Suggested Fields of Concentration

ENGINEERING ADMINISTRATION HOURS

Accy. 201 — Fundamentals of Accounting or Accy. 206 — Cost Accounting for Engineers	3
B. Adm. 210 — Management and Organizational Behavior, or B. Adm. 247 — Introduction to Management	3
B. Adm. 314 — Production	3
B. Adm. 315 — Management in Manufacturing	3
B. Adm. 321 — Individual Behavior in Organizations	3
B. Adm. 323 — Organizational Design and Environment	3
B. Adm. 351 — Personnel Administration	3
Fin. 254 — An Introduction to Business Financial Management, or Fin. 257 — Corporation Finance	3
G.E. 330 — Industrial Standardizations	2
G.E. 392 — Legal Problems in Engineering Design	3
I.E. 238 — Analysis of Data	3
I.E. 335 — Industrial Quality Control	3
I.E. 357 — Safety Engineering	3
I.E. 385 — Operations Research I	3-4
I.E. 388 — Applications of Operations Research to Industrial Systems	3
B.&T.W. 251 — Business and Administrative Communication	3

ENGINEERING MARKETING

Accy. 201 — Fundamentals of Accounting	3
B. Adm. 202 — Principles of Marketing, or B. Adm. 272 — Industrial Selling	3
B. Adm. 320 — Marketing Research	3
B. Adm. 337 — Promotion Management	3
B. Adm. 344 — Consumer Behavior	3
B. Adm. 360 — Marketing Logistics	3
G.E. 330 — Industrial Standardization	2
G.E. 392 — Legal Problems in Engineering Design	3
I.E. 238 — Analysis of Data	3
Psych. 245 — Industrial Organizational Psychology	3
B.&T.W. 251 — Business and Administrative Communication	3

ENVIRONMENTAL QUALITY

C.E. 240 — Control of the Urban Environment	3
C.E. 241 — Air and Water Quality	3
C.E. 340 — Physical Principles of Environmental Engineering Processes	3
C.E. 341 — Air Resources Management	2
C.E. 342 — Water Quality Control Processes	3
C.E. 343 — Chemical Principles of Environmental Engineering Processes	3-4
C.E. 344 — Solid Wastes Management	4
C.E. 346 — Biological Principles of Environmental Engineering Processes	3
G.E. 348 — The Air Pollution System	1-2
C.E. 349 — Air Resources Engineering	3
M.E. 303 — Dynamics of Aerosols and Hydrosols	3
M.E. 333 — Air Pollution and Combustion	3
E.E.E. 359 — Aquatic Ecology	3

COMPUTER SCIENCE

Any Computer Science course beyond C.S. 101	
G.E. 293 — Section C, Computer Graphics in Engineering	3

MINING AND GEOLOGICAL ENGINEERING

C.E. 201 — Engineering Surveying ¹	4
C.E. 280 — Introduction to Soil Mechanics and Foundation Engineering	3
C.E. 383 — Soil Mechanics and Soil Properties	4
C.E. 384 — Applied Soil Mechanics	4
Geol. 107 — General Geology I ¹	4
Geol. 108 — General Geology II ¹	4
Geol. 233 — Minerals and Rocks	4
Geol. 311 — Structural Geology	4
Geol. 332 — Mineralogy-Petrology	4
I.E. 238 — Analysis of Data	3
I.E. 357 — Safety Engineering	3
Math. 343 — Advanced Calculus	3
Met. E. 207 — Extractive Metallurgy ¹	3
Min. E. 356 — Rock Mechanics ¹	3
Any mining engineering course	1-4

¹These courses are required in the mining engineering option. Twelve of these hours will count as the secondary field, and the remainder will be substituted for other courses with the approval of the advisor.

One of the key factors in the successful presentation of the courses was the development of the teaching staff since each course covered topics in machine design and structural design. Since the general engineering faculty was composed of graduates of a wide variety of engineering disciplines, the courses were first presented on a team teaching basis with two or more persons giving the lectures.

Another important facet in the teaching of these courses was to have as much orientation to actual engineering practice as possible. Many of the faculty had from 3 to 20 years of industrial experience. As time went on and the faculty became familiar with all the topics being presented in each course, the team-teaching was discontinued and each course was taught by an individual faculty member, except for the senior design course, GE 242, Project Design. For the project design course, the class was divided into teams usually of three students with a faculty member as an adviser. The projects were problems from various industries.

The faculty were encouraged to attend various technical and professional society meetings to gain insights to expand their backgrounds in teaching design. In addition, various individuals were invited to come to campus and discuss engineering design education. In April 1965, Morris Asimow of UCLA was invited to give several seminars on "Engineering Design, a New Approach."

BUILD Conference

In 1964, the colleges of engineering at the University of Illinois and the University of Colorado received a grant whereby a large well-established college of engineering would assist a lesser developed college in upgrading its program. This program was labeled the Bi-University Institutional Liaison and Development (BUILD) program.

In February 1965, a team from the University of Illinois participated with a team at the University of Colorado in a conference. Three faculty members from the Department of General Engineering — Jerry S. Dobrovolny, Ronald L. Placek (joined the department in 1957), and Donald E. Scheck (joined the department in 1954) — were invited to confer with the faculty at Colorado in the development of a curriculum in engineering design and economic evaluation at the University of Colorado. The program was to be patterned after the newly established project design sequence recently implemented in the general engineering curriculum at the University of Illinois.

Ford Foundation Grant

As was mentioned before, the 1954 ASEE Grinter Report stated the need for more mathematical analysis in engineering design. Many of the design courses in the civil and mechanical engineering curricula throughout the country went overboard in dropping the detail design aspects and concentrating on the analysis thrust. In the early 1960s, a number of engineering educators felt the overemphasis on analysis in design was detrimental to teaching engineering design. Several schools, including the Massachusetts Institute of Technology, Carnegie Mellon, Syracuse, University of California at Los Angeles and at Berkeley, and Rensselaer approached the Ford Foundation for grants to support the development of design courses that were both analytical and applied.

In September 1962, a conference was held at UCLA to report on the progress of the efforts of the institutions participating in the programs. Dobrovolny attended the conference and was struck by the similarity of the objectives presented with those being inculcated in the newly developing courses in the general engineering curriculum. Following conversations with the Ford Foundation representatives, Dobrovolny submitted a proposal in August 1965 to support the development of the general engineering programs in integrated engineering design education. The proposal was funded in May 1966 at the level of \$120,000. Dobrovolny served as project director and Bernt O. Larson as associate project director. The grant was to enable the Department of General Engineering to do the following:

1. Provide released time for the staff to write up case studies in engineering design,
2. Provide released time for the staff to develop supplemental class notes and teaching aids for the several design courses,
3. Provide funds to bring selected project engineers from industry to work directly with faculty and students on live design projects, and
4. To develop a freshman course on the introduction of design philosophy.

During the first year of the grant (June 1, 1966–May 31, 1967) 18 companies sent representatives to the campus to discuss the need for industry-university cooperation in the Ford Foundation grant. Some of the early involvements were with the Western Electric Co. of Chicago, Illinois, which released two outstanding senior design staff engineers to come to the campus twice a week to act as mentors for senior design projects. The projects were based on problems from Western Electric.

One of the engineers, J. J. Mellon, wrote in his evaluation after spending a year in the program, the following:

"In concept and implementation, the General Engineering effort in this virgin field deserved and can expect only the highest acclaim and support from everyone, industrial and academic, acquainted with the program. It is a sophisticated approach, a practical solution to a continuing problem. The value of this effort to speed the evolution of effective engineering cannot be over-estimated. I can only hope that this association has been a means of strengthening our industrial-academic ties that will continue in satisfying official and personal relationships."

During the spring of 1966, Armin F. Fick, vice president, manufacturing, of the Western Electric Co., in an address to the faculty of the College of Engineering, said this experiment between his company and the Department of General Engineering was a most important one in linking college and industry efforts in the training of the engineering student for their future careers.

In addition to Western Electric, two other firms participated in this first year of the grant. They were the Universal Bleacher Co., Champaign, Illinois, and Eugene Daily, a consulting engineer also of Champaign. One of the challenges in having students work on design problems from industry was identifying in advance the scope of the work that could be completed in one semester.

Some of the other activities during the first year of the Ford Foundation grant provided funds for other aspects of the proposal. Ronald J. Placek attended an NSF Summer Institute on Case Methods at Stanford University in 1966. He was awarded a grant to conduct a similar NSF program for the summer of 1967 to be held at the Chicago Circle Campus of the University of Illinois for midwest university engineering faculty.

Three faculty from other universities were brought to the campus to present engineering design cases to the senior design students and exchange ideas with the faculty on the use of case studies in the teaching of engineering design. They were: G. H. Savage, University of New Hampshire; P. L. Bulkley, Stanford University; and E. J. Smith, Rensselaer Polytechnic Institute.

Several tours to manufacturing companies were conducted for the senior students. Various faculty members visited companies to obtain further background in how design was implemented in manufacturing. Several design projects were developed from these visits.

The freshman engineering graphics course was modified to introduce some elementary design projects. In some cases the freshmen assisted the upper classmen as technicians doing library research and drafting.

Several of the staff were granted release time to develop class notes to implement the cross-disciplinary design courses being developed.

John P. Hipskind (joined the department in 1954) developed and introduced four separate engineering design case studies in the second semester freshman course, GE 104. He also was selected to be a participant in an NSF-sponsored Case Study Institute in the summer of 1967.

During the second year of the grant (1967–68), staff members continued to develop class notes for the various integrated design courses. Two senior design engineers from the Continental Can Co. came to campus every other week to serve as consultants to the design projects that the senior students in GE 242 were working on. This was in the first semester.

In the second semester, Charles F. Gebhardt, design engineer from Caterpillar in Decatur, Illinois, came every week to advise the students. He continued this activity for many years until he retired. The Illinois Bell Telephone Co. also assigned one of its engineers to participate in the program.

Ernest E. Blanco of Tufts University was invited as a guest lecturer to present case studies and lectures on engineering design on April 1–4, 1968. He also reviewed all of the general engineering design courses and in his report made recommendations for improvement. One of his recommendations was to submit six of the design projects to the 1968 James F. Lincoln Arc Welding Foundation's national undergraduate design competition. One of the projects was judged a second place winner, which carried with it a cash stipend to the students as well as a plaque to the department. Every year since then, projects have been entered and have been judged anywhere from a first place award to a merit recognition. By 1995, 50 such awards have been received. A list of these is included in Chapter 6, Student and Alumni Activities.

Three of the jig design projects from GE 104 were entered in the Introductory Creative Design Graphics Display sponsored by the Division of Engineering Graphics of the American Society for Engineering Education (ASEE) at the 1968 annual convention. Two of the projects were judged "excellent" and were awarded the appropriate ribbons and certificates.

As a capstone to the Ford Foundation grant, Dobrovlny contacted the Engineering Design Committee of ASEE to sponsor a national conference on engineering design and design education. This was the fifth such conference on engineering design education held under ASEE sponsorship.

The conference was held at the Krannert Center for the Performing Arts at the Urbana-Champaign campus of the University of Illinois on July 15-16, 1971. There were over 70 participants from across the nation ranging from such institutions as MIT, Stanford University, University of Toronto, Case Western Reserve, etc. In all, 45 institutions were represented. A copy of the table of contents of the proceedings is in the appendix.

In the early years of GE 242, the projects were from local companies and from projects based on faculty experiences. In 1969, Dobrovlny had returned from San Antonio, Texas, where a portion of the San Antonio River had been converted into a tourist attraction. He presented the idea of cleaning up and redeveloping the Boneyard Creek running through the engineering campus. The students formed an organization called The Concerned Engineers for the Restoration of the Boneyard.

The project was divided into approximately two-block segments with a project team assigned to each segment. The students established a hotline to receive calls about pollution sources, which were then reported to the proper authorities. One of the section projects dealt with Scott Park in Champaign. The student had proposed a design that would provide a flood retention basin. The Champaign City Council was about to award a contract to confine the flow between steel pilings covered with concrete. The student project team presented its design to the City Council and persuaded the members to cancel the steel piling plan and to adopt the GE 242 project design. This design was subsequently implemented with minor revisions and Scott Park is now a pleasant recreational area with a stream running through it.

As a result of this, Commissioner William J. Helms, of the Champaign Park District, took an interest in preserving the Boneyard Creek as an attractive unpolluted waterway and was responsible for establishing the Boneyard Conservation Drainage District. A 100-year plan was suggested to establish walkways and bike paths along the stream.

Industry Support for Design Projects

After the funds from the Ford Foundation grant were expended in 1971, the department was faced with discontinuing the engineering project design activity because of the costs associated with it. During the six-year period of funding under the Ford grant, contacts had been made with a number of engineers in industry. Many of the projects the students had worked on from these industries proved to have saved money for the companies.

The concept was developed by Bernt O. Larson and Roland L. Ruhl to approach these and other industries for financial support to continue the senior project design activity. In the implementation of this program, the company was approached to identify specific projects. The general engineering faculty would help in defining the project in terms of doability in one semester. The students in class would be given a list of projects obtained for a particular semester and would be asked to indicate their first and second choices.

The faculty then selected the project teams based on the student's choice and academic background. The teams were made up of three students with a faculty member assigned as a mentor. The company also identified a staff engineer to serve as the company mentor. The students would then visit the company site to see first-hand the problem environment. The company provided a financial contribution to the department. These funds were placed in a separate account and the monies were used for travel and other expenses associated with each project, as well as for staff development.

The students prepared a final written report at the end of each semester. Each project team presented its results at a design symposium. Company representatives were invited to these presentations, which were followed by a luncheon. These sessions were conducted as technical paper presentations. Nonparticipating company representatives also were invited to be approached for future involvement in the program.

Ten copies of each project report were prepared. Three were sent to the sponsoring company, one copy was sent to the Engineering Library, one to each student, and one was placed in the permanent files in the department. The others were used when soliciting company sponsors.

The Department of General Engineering has received many national recognitions for its project design activity. In recent years, the Accreditation Board for Engineering and Technology (ABET) — previously ECPD — are now recommending all engineering curricula incorporate a capstone senior design project.

Mining and Geological Engineering Option

As a member of the Illinois Mining Institute, Department Head Dobrovolny received letters from various coal company representatives in 1965 indicating their interest in promoting student enrollment in mining engineering programs. The reason for this interest resulted from action on the mining engineering curriculum occurring in the College of Engineering.

On September 24, 1963, Dean W. L. Everitt appointed a Committee on Earth Science Oriented Engineering:

"to evaluate the changing needs and demands in the academic training of engineers and applied scientists in the fields of mining and reservoir engineering, geophysics, rock mechanics, mineral processing, and related fields requiring an engineering approach to the application of the earth sciences."

The committee members were:

A. P. Boresi, Theoretical and Applied Mechanics
D. U. Deere, chair, Civil Engineering and Geology
J. S. Dobrovolny, General Engineering
A. F. Hagner, Geology
H. E. Risser, State Geological Survey
W. D. Rose, Mining, Metallurgy and Petroleum Engineering
F. D. Wright, Mining, Metallurgy and Petroleum Engineering

The committee report was submitted in May 1965. One of the recommendations was: "the discontinuation of the undergraduate program in Mining Engineering." It further recommended that the 300-level courses in mining be retained "as electives for undergraduate students in the existing Engineering Geology Option in General Engineering." In September 1966, the undergraduate curriculum in mining engineering was discontinued.

As a result of this action, the engineering geology option in general engineering was expanded to be a geoscience option to enable students interested in mining engineering to pursue their career goals. In 1971, George R. Eadie was transferred from the Department of Metallurgy and Mining Engineering to the Department of General Engineering and was an adviser for students interested in mining engineering. Alan D. Krug (joined the department in 1967) assisted in this effort.

A continuing dialogue with the coal companies resulted in a conference on Engineering Manpower Needs

of the Illinois Mining Industry, sponsored by the Department of General Engineering on September 11, 1973. Participants included representatives from 10 coal companies, U.S. Bureau of Mines, Illinois Department of Mines and Minerals, Illinois Coal Operator's Association, Inc., Illinois State Geological Survey, as well as members of the Department of General Engineering.

The conference participants agreed to continue with the cooperative efforts of the department's faculty and industry representatives in two specific projects related to the undergraduate program in mining engineering. One project was to develop a program to be presented to high school and community college audiences to acquaint them with the need for engineers in the mining industry and the options available in the department. The other was to organize a committee to review the mining option in general engineering and to recommend whatever changes would be required to meet the manpower needs of the Illinois mining industry.

A curriculum committee was formed with representatives from five coal companies, a member from the state Department of Mines and Minerals, and George R. Eadie and Edward D. Ebert (joined the department in 1946) from the department to serve as co-chairs. The committee met in Springfield, Illinois, in October 1973 and outlined a plan to study the mining option. The committee analyzed curricula from eight schools with mining programs. These data were compared with the then-present program in the Department of General Engineering and a proposal was made to modify the option. This was considered at the meeting of the curriculum committee on April 26, 1974. The committee accepted the revisions. A subsequent brochure was developed outlining the options in mining and geological engineering in the general engineering curriculum.

As a further effort to bring to the attention of students the opportunities in mining engineering, the Illinois Society of General Engineers invited several mining industry representatives to make presentations at its September 18, 1974, meeting. Over 50 students attended. As a follow-up, 21 students went on a field trip on October 26, 1974, to visit several midwest division mines of the Consolidation Coal Co.

Curriculum Revisions

Through the years, after the 1961 curriculum in general engineering was adopted, there were minor changes in the program, such as dropping GE 104, adding CS 101, and adding GE 234. In 1991, in an effort to update the subject matter in the various design courses to be more in line with present day practices, a department committee was formed to develop a new curriculum. The new program was approved in January 1994 and is listed on page 29.

Curriculum for the Bachelor of Science in General Engineering, 1994

Total credit hours required for the degree—131

SEMESTER 1 ^a	15 hours	SEMESTER 2	16 hours
Chem. 101 — General Chemistry	4	Math. 225 — Introductory Matrix Theory	2
Eng. 100 — Engineering Lecture	0	Math. 130 — Calculus and Analytic Geometry II	3
G.E. 103 — Engineering Graphics and Design	3	PhyCs. 106 — General Physics-Mechanics	4
Math 120 — Calculus and Analytic Geometry I	5	Rhet. 105 — Principles of Composition	4
Econ. 102 or Econ. 103 (Elective in Social Sciences or Humanities ^d)	3	Elective in Social Sciences or Humanities	3
SEMESTER 3	17 hours	SEMESTER 4	17 hours
C.S. 101 — Introduction to Computing for Application to Engineering and Physical Science	2	Physics 108 — General Physics-Light, Sound, and the Structure of Matter	4
Math 242 — Calculus of Several Variables	3	Math. 285 — Differential Equations and Orthogonal Functions	3
PhyCs. 107 — General Physics-Heat, Electricity, and Magnetism	4	T.A.M. 212 — Engineering Mechanics II-Dynamics	3
T.A.M. 150 — Analytical Mechanics- Statics	2	T.A.M. 221 — Elementary Mechanics of Solids	3
Elective in Social Sciences or Humanities ^d	3	C.S. 110 — Programming Laboratory	1
Elective in Social Sciences or Humanities ^d	3	Elective in Social Sciences or Humanities ^d	3
SEMESTER 5	17 hours	SEMESTER 6	17 hours
G.E. 221 — Introduction to General Engineering Design	3	G.E. 225 — Instrumentation and Test Laboratory	1
G.E. 222 — Design and Analysis of Dynamic Systems	3	G.E. 226 — Laboratory for Data Analysis	1
G.E. 224 — Dynamic Systems Laboratory	1	G.E. 232 — Engineering Design Analysis	4
G.E. 288 — Engineering Economy and Operations Research	3	G.E. 289 — Probabilistic Decision Making	3
E.C.E. 270 — Introduction to Circuit Analysis	4	GE 323 — State Space Design Methods in Control	3
Secondary field elective ^b	3	E.C.E. 244 — Electrical Engineering Laboratory I	2
SEMESTER 7	16 hours	Secondary field elective ^b	3
G.E. 292 — Engineering Law	3	SEMESTER 8	16 hours
T.A.M. 235 — Fluid Mechanics	4	G.E. 291 — General Engineering Seminar	0
M.E. 209 — Thermodynamics and Heat Transfer	3	G.E. 342 — Project Design I	2
Design elective ^c	3	G.E. 343 — Project Design II	2
Secondary field elective ^b	3	Secondary field elective ^b	3
		Elective in Social Sciences or Humanities ^d	3
		Free elective	3
		Free elective	3

^aIt is recommended that freshmen with appropriate backgrounds in analytical geometry take the Math 135, 245 calculus sequence instead of Math 120, 130, 242, delaying Math 225 to the sophomore year.

^bTo be selected from the lists established by the Department or by petition of the Department.

^cTo be selected from the Departmental List of Design Electives (including G.E. 241) that have an acceptable level of design content.

^dTo be selected from the College of Engineering approved list of Social Science and Humanities electives, and to comply with the campus General Education requirements.

General Engineering Course Descriptions

G.E. 103—Engineering Graphics and Design. Develops the spatial concepts needed to allow the student to communicate graphically and pictorially in an engineering framework, and includes computer-based orthographic projection and descriptive geometry. Introduces the student to engineering design through the vehicle of a few elementary design projects carried out throughout the semester.

G.E. 221—Introduction to General Engineering Design. Introduces the student to static analysis concepts of structural and machine components and assemblies, and to kinematics of mechanisms. This introduction builds upon earlier course work to provide a broad framework for analysis and design. Computer solutions are stressed, and the student is required to carry out designs.

G.E. 222—Design and Analysis of Dynamic Systems. Operational techniques used in describing, analyzing and designing linear continuous systems; modeling, equilibrium points and linearization; Laplace transforms; response via transfer functions, stability; performance specifications; controller design via transfer functions; frequency response; simple nonlinearities.

G.E. 224—Dynamic Systems Laboratory. Simulation and testing of dynamic systems; system identification and control synthesis; digital methods of data acquisition.

G.E. 225—Instrumentation and Test Laboratory. Preparation for experimental projects; introduction to mechanical and electrical instruments; mechanical testing of materials; introduction to experimental stress analysis and photoelastic methods.

G.E. 226—Laboratory for Data Analysis. Measurement error and analysis of collected data; execution of a designed experiment; goodness of fit; model validation for simulation.

G.E. 232—Engineering Design Analysis. Carries onward the concepts learned earlier in engineering mechanics, and develops the area of engineering behavior of materials. Stress conditions in various materials and configurations are applied toward the development of design criteria and practical designs. Several small projects, including one experimental one, are used to illustrate the concepts.

G.E. 241—Component Design. Applies knowledge obtained in the courses above to the design of practical engineering devices and subsystems, including mechanical structural and dynamical behavioral aspects of such systems. Modern computational, modeling, and analysis techniques are used whenever applicable so as to provide the student with firsthand experience with the latest engineering techniques.

G.E. 242—Project Design. Design of various engineering devices and systems. Teams of 2–4 students work toward the development of engineering solutions to problems supplied by industry. A midterm and final oral report summarize the work of the semester for sponsor and faculty.

G.E. 288—Engineering Economy and Operations Research. Introduction to an operations research approach to engineering decision making; economic analysis of alternatives; linear, integer, basic nonlinear and dynamic programming with specific applications to engineering problems.

G.E. 289—Probabilistic Decision Making. Review of introductory probability and statistics that develops more advanced concepts as needed, in the context of engineering design and decision making; designing experiments and analyzing results, with applications to robust design; Bayesian decision theory, with applications to engineering management and design; simulation modeling using a modern simulation language with applications to manufacturing process decisions.

G.E. 292—Engineering Law. First traces the origins of the U.S. legal system, how it is structured and used. Then specific topics such as formation and enforcement of contracts, torts, laws of agency and labor, personal and real property, sales, and liability for defective products are explored, emphasizing applications to the engineering profession.

G.E. 323—State Space Design Methods in Control. Design methods; time domain modeling; trajectories and phase plane analysis; similarity transform; controllability and observability; pole placement and observers; linear quadratic optimal control; Lyapunov stability and describing functions; simulation.

Secondary Fields of Concentration for the Undergraduate Curriculum in General Engineering

Effective Fall 1994

The secondary field provides virtually unlimited opportunity and flexibility to tailor the General Engineering curriculum to one's interests and career goals. Secondary fields are of two types, pre-approved and customized, as described below. Secondary fields may be technically or non-technically oriented. Each requires a minimum of 12 hours of coursework.

Pre-approved Secondary Fields

Pre-approved secondary fields consist of related courses in the areas of study listed below. No formal declaration is necessary. From the course lists for each field, any 12 hours of credit may be selected. However, requests for the substitution of courses not listed here may be made via a petition form submitted to the Department of General Engineering. Approval is based on the coherence of the complete set of courses chosen.

Automotive Engineering	Hours
ECE 386–Control Systems	4
GE 324–Digital Control of Dynamic Systems	4
GE 389–Robot Dynamics and Control	4
ME 303–Applied Combustion	3
ME 312–Modern Control Theory	4
ME 313–Computer Control of Mechanical Engineering Systems	3
ME 331–Internal Combustion Engines	3
ME 336–Automotive Vehicle Dynamics	3–4
ME 388–Industrial Control Systems	3
TAM 311–Vibrations of Mechanical Systems I	3
TAM 314–Advanced Dynamics for Engineers	3

Bioengineering¹ (Engineering Option)	Hours
BIOCH 350–Introductory Biochemistry	3
BIOEN 120–Introduction to Bioengineering	1
BIOEN 308–Implant Materials for Medical Applications	3
BIOPH 301–Introduction to Biophysics	3
CHEM 231–Elementary Organic Chemistry	3
ECE/BIOEN 314–Biomedical Instrumentation	3
ECE/BIOEN 315–Biomedical Instrumentation Laboratory	2
ECE/BIOEN 375–Modeling of Bio-Systems	3 or 4
GE 293(MHM)–Biomechanics Special Topics	1
KINES 255–Biomechanical Analysis of Human Movement	3
ME 375–Introduction to Bionics	3
PHYCS 343/CHEM 323–Electronic Circuits I	5
PHYSL 103–Introduction to Human Physiology	4

PHYSL 301–Cell and Membrane Physiology	3
PHYSL 302–Systems and Integrative Physiology	3
PHYSL 303–Cell and Membrane Physiology Laboratory	2
PHYSL 304–Systems and Integrative Physiology Laboratory	2
V B/BIOEN 306–Veterinary Orthopedic Biomechanics	3

¹ Students fulfilling the College of Engineering Option in Bio-engineering will automatically satisfy the Bioengineering secondary field requirement

Civil Engineering Structures	Hours
CE 263–Behavior and Design of Metal Structures I	3
CE 264–Reinforced Concrete Design I	3
CE 280–Introduction to Soil Mechanics and Foundation Engineering	3
CE 365–Design of Structural Systems	3
CE 398 (SA)–Methods of Structural Analysis	4
MATH 280–Advanced Calculus	3
MATH 315–Linear Transformations and Matrices	3

Computer-Aided Design and Manufacturing (CAD/CAM)	Hours
CS 225–Data Structures and Software Principles ¹ (or CS 300–Data Structures for Non-Computer Majors ¹ - 2 hrs)	4
CS 318–Computer Graphics ¹	3
CS/ECE 348–Introduction to Artificial Intelligence	3
GE 393 (YSK)–Computer-Aided Design Systems ¹	3
GE 493 (YSK)–Solid Modeling and CAD/CAM Applications ²	4
IE 350–Computer-aided Manufacturing Systems	3
MFG E 210–Introduction to Manufacturing Systems	3
ME 285–Design for Manufacturability ¹	3
ME 366–Knowledge-Based Systems in Engineering	3

¹ Recommended course

² Undergraduates may take this course

Computer Science¹	Hours
CS 173–Discrete Mathematical Structures ²	2
CS 225–Data Structures and Software Principles ²	4
CS 300–Data Structures for Non-Computer Majors ²	2
All other 200- or 300-level courses	

¹ Students with a strong interest in courses other than CS 300-304 are encouraged to take CS 125 in place of CS 101 and/or CS 223 in place of CS 110

² Recommended course

Control Systems	Hours
CS 225–Data Structures and Software Principles	4
ECE 309–Signal and System Analysis	3
ECE 313–Probabilistic Methods of Signal and System Analysis	3
ECE 386–Control Systems	4
ECE 390–Introduction to Optimization	3
GE 324–Digital Control of Dynamic Systems	4
GE 389–Robot Dynamics and Control	4
MFG E 330–Interfacing Methods for Manufacturing Systems	3
MATH 361/STAT 351–Introduction to Probability Theory I	3
ME 312–Modern Control Theory	4
ME 313–Computer Control of Mechanical Engineering Systems	3
ME 388–Industrial Control Systems	3

Engineering Administration	Hours
ACCY 201–Principles of Accounting I	3
ACCY 202–Principles of Accounting II	3
ADV 281–Introduction to Advertising	3
B ADM 210–Management and Organizational Behavior	3
B ADM 314–Production	3
B ADM 315–Management in Manufacturing	3
B ADM 321–Individual Behavior in Organizations	3
B ADM 323–Organizational Design and Environment	3
B ADM 351–Personnel Administration	3
B ADM 382–Introduction to International Business	3
B ADM 384–International Management	3
B&TW 251–Business and Administrative Communication ¹	3
B&TW 252–Technical Communication ²	3
ECON 300–Intermediate Microeconomic Theory	3
ECON 301–Intermediate Macroeconomic Theory	3
FIN 254–Corporate Finance	3
GEOG/B ADM 205–Business Location Decision-Making: Theory and Practice	3
IE 238–Analysis of Data	3
IE/GE 334–Introduction to Reliability Engineering	3
IE 335–Industrial Quality Control	3
IE 336–Design and Analysis of Industrial Experimentation	3
IE 373–Production Planning and Control	3
IE 386–Operations Research II	3–4

MFG E 210–Introduction to Manufacturing Systems	3
MFG E 320–Decision-Making and Control Applications in Manufacturing	3
MFG E 350–Information Management for Manufacturing Systems	3
POL S/ACCY/B ADM/SOC S 300–Socio-Economic Management as Public Policy	3
PSYCH/AVI 258/IE 248–Human Factors in Human-Machine Systems	3
PSYCH/AVI 356/IE 346–Human Performance and Engineering Psychology	3
¹ To be replaced by B&TW 253 during 1994–95 school year	
² To be replaced by B&TW 261 during 1994–95 school year	

Engineering Marketing	Hours
ACCY 201–Principles of Accounting I	3
ACCY 202–Principles of Accounting II	3
B ADM 202–Principles of Marketing	3
B ADM 210–Management and Organizational Behavior	3
B ADM 320–Marketing Research	3
B ADM 337–Promotion Management	3
B ADM 344–Buyer Behavior	3
B ADM 360–Marketing to Business and Government	3
B ADM 370–International Marketing	3
B ADM 380–Advanced Marketing Management	3
B ADM 382 Introduction to International Business	3
B&TW 251–Business and Administrative Communication ¹	3
B&TW 252–Technical Communication ²	3
IE 238–Analysis of Data	3
PSYCH 245–Industrial Organizational Psychology	3
¹ To be replaced by B&TW 253 during 1994–95 school year	
² To be replaced by B&TW 261 during 1994–95 school year	

Environmental Quality	Hours
AG EC/ENVST/FOR 317–Introduction to Natural Resources Economics	3
CE 241–Environmental Quality Engineering	3
CE 336–Hazardous Waste Management	3
CE 337–Managing Wastewaters in Aquatic Ecosystems	2
CE 338–Biomonitoring: Design, Analysis and Interpretation	3
CE 340–Physical Principles of Environmental Engineering Processes	3
CE 341–Regional Environmental Management Simulation	2
CE 342–Water Quality Control Processes	3
CE 343–Chemical Principles of Environmental Engineering Processes	2–4
CE 344–Solid Waste Management	3
CE 345–Atmospheric Dispersion Modeling	3

CE 346–Biological Principles of Environmental Engineering Processes	3
CE 347–Stream Ecology	3
CE 349–Air Resources Engineering	3
EEE 105–Environmental Biology	3
ENVST/AGRON 236/CHLTH 266–Tomorrow’s Environment	3
ENVST 331/CHLTH 361–Toxic Substances in the Environment	3
ENVST/PSYCH 372–Environmental Psychology	3
FOR/AGRON/ENVST 319–Environment and Plant Ecosystems	3
ME 303–Applied Combustion	3
NUC E/ENVST 241–Introduction to Radiation Protection	2

Manufacturing Engineering¹ Hours

MFG E 210– Introduction to Manufacturing Systems ²	3
MFG E 320–Decision-Making and Control Applications in Manufacturing ²	3
MFG E 330–Interfacing Methods for Manufacturing Systems ²	3
MFG E 340–Processing and Finishing of Materials ²	3
MFG E 350–Information Management for Manufacturing Systems ²	3

Other courses must be chosen from the approved lists for the Computer-Aided Design and Manufacturing (CAD/CAM), Operations Research, and Control Systems secondary fields

¹ Students fulfilling the College of Engineering Option in Manufacturing Engineering will automatically satisfy the Manufacturing Engineering secondary field requirement

² At least two of these MFG E courses must be chosen

Nondestructive Testing and Evaluation Hours

CS 346–Pattern Recognition and Machine Learning	3
CS 348/ECE 348–Introduction to Artificial Intelligence	3
ECE 309–Signal and System Analysis	3
ECE 374–Ultrasonic Techniques	3
GE 324–Digital Control of Dynamic Systems	4
GE 389–Robot Dynamics and Control	4
GE 393(HRM)–Principles of Nondestructive Evaluation ¹	3
IE 238–Analysis of Data	3
IE/GE 334–Introduction to Reliability Engineering ²	3
ME 285–Design for Manufacturability	3
ME 345–Introduction to Finite Element Analysis	3
TAM 224–Behavior of Materials ²	4
TAM 314–Advanced Dynamics for Engineers	3
TAM 326–Experimental Stress Analysis	3
TAM/ECE 373–Fundamentals of Engineering Acoustics	3

¹ Required course

² Recommended course

Operations Research Hours

IE 238–Analysis of Data	3
IE/GE 334–Introduction to Reliability Engineering	3
IE 350–Computer-aided Manufacturing Systems	3
IE 363–Facilities Planning and Design	3
IE 370–Industrial Engineering Design Laboratory	3
IE 373–Production Planning and Control	3
IE 386–Operations Research II	3 or 4
MFG E 320–Decision-Making and Control Applications in Manufacturing	3
MFG E 350–Information Management for Manufacturing Systems	3
STAT 310/MATH 363–Introduction to Mathematical Statistics and Probability I	4

Quality Control Hours

B ADM 315–Management in Manufacturing	3
IE 238–Analysis of Data	3
IE/GE 334–Introduction to Reliability Engineering	3
IE 335–Industrial Quality Control	3
IE 336–Design and Analysis of Industrial Experimentation	3
IE 373–Production Planning and Control	3
ME 285–Design for Manufacturability	3
STAT 310/MATH 363–Introduction to Mathematical Statistics and Probability I	4
STAT 311/MATH 364–Introduction to Mathematical Statistics and Probability II	3

Rehabilitation Engineering Hours

CSB 234–Functional Human Anatomy	5
CSB 322–Anatomy of the Human Extremities	2
ECE/BIOEN 314–Biomedical Instrumentation	3
ECE/BIOEN 315–Biomedical Instrumentation Laboratory	2
GE 293(MGS)–Rehabilitation Engineering Design	2–3
GE 393 (MS1)–Introduction to Rehabilitation Engineering	4
GE 393 (MS3)–Biomechanics and Assistive Technology Design	4
REHAB 301–Introduction to Rehabilitation	4
REHAB 302–Medical Aspects of Disabilities	4
REHAB 340–Introduction to Sensory Impairments	4
REHAB 344–Introduction to Adaptive Technologies for Persons with Disabilities	4

Robotics	Hours	Theoretical and Applied Mechanics	Hours
CS 346–Pattern Recognition and Machine Learning	3	ME 345–Introduction to Finite Element Analysis	3
CS 347–Knowledge-Based Programming	3	TAM 224–Behavior of Materials	4
CS/ECE 348–Introduction to Artificial Intelligence	3	TAM 311–Vibrations of Mechanical Systems I	3
CS 375–Automata, Formal Languages, and Computational Complexity	3	TAM 314–Advanced Dynamics for Engineers	3
ECE 291–On-Line Computing	3	TAM 324–Flow and Fracture of Structural Metals	3
ECE 375–Modeling of Bio-Systems	3–4	TAM 326–Experimental Stress Analysis	3
ECE 386–Control Systems	4	TAM 327–Deformation and Fracture of Polymeric Materials	3
ECE 390–Introduction to Optimization	3	TAM 328–Mechanical Behavior of Composite Materials	3
GE 293(MWS)–Robotics Laboratory	3	TAM 335–Dynamics of Fluids	3
GE 324–Digital Control of Dynamic Systems	4	TAM 351–Fundamental Concepts of Deformable Body Mechanics	3
GE 389–Robot Dynamics and Control	4	TAM 360–Continuum Mechanics I	3
GE 493 (YSK) Solid Modeling and CAD/CAM Applications	3		
IE/GE 334–Introduction to Reliability Engineering	3		
ME 285–Design for Manufacturability	3		
ME 313–Computer Control of Mechanical Engineering Systems	3		
ME 342–Kinematic Analysis and Synthesis	3		
ME 375–Introduction to Bionics	3		

Customized Secondary Fields

Customized secondary fields can be created to achieve specific career goals not addressed by pre-approved secondary fields. To do so, a petition form stating the title and courses of the secondary field must be submitted to the department for acceptance. Approval is based on both the merit of the secondary field and the coherence of the courses within it relative to the student's goals. The following list contains examples of customized secondary fields that can or have been petitioned.

Accountancy	Cinematography	Japanese (or any other language)
Acoustics	Circuit Analysis and Design	Landscape Architecture
Agricultural Engineering (or any other engineering discipline)	Construction	Machine Design
Agronomy	Economics Energy	Meteorology
Animal Science	Finance	Mining and Geological Engineering
Applied Mathematics	Finite Element Analysis	Philosophy
Applied Statistics	Fluid Dynamics	Political Science
Astronomy	Food Science	Power Systems
Audio Engineering	Geography	Pre-Dentistry
Aviation	Heat Transfer	Pre-Law
Biology	History of Engineering, Science and Technology	Pre-Medicine
Chemistry	Human Factors	Pre-Veterinary Science
	Industrial Design	Railroad Engineering
	Industrial Psychology and Organizational Behavior	Solar Energy
	Insurance and Actuarial Science	Technical Journalism
	International Business	Telecommunications
		Thermal Science
		Thermodynamics
		Vehicle Dynamics

Number of Undergraduate Enrollments and BS Degree Graduates

The enrollments in the general engineering curriculum began as soon as the program was approved in 1921 with 44 students. The first semester enrollments through 1994 are shown in Table 1 and shown graphically in Figure 3. Table 2 lists the number of graduates by year from 1923 through 1995 with a total of 3,317. These data are also shown as a graph in Figure 4.

Table 1. Fall Enrollment in General Engineering

Year	Students	Year	Students	Year	Students
1921-22	44	1946-47	281	1971-72	340
1922-23	97	1947-48	231	1972-73	314
1923-24	110	1948-49	212	1973-74	368
1924-25	102	1949-50	187	1974-75	407
1925-26	105	1950-51	128	1975-76	470
1926-27	101	1951-52	138	1976-77	500
1927-28	101	1952-53	148	1977-78	496
1928-29	86	1953-54	171	1978-79	533
1929-30	85	1954-55	198	1979-80	583
1930-31	98	1955-56	207	1980-81	612
1931-32	95	1956-57	233	1981-82	577
1932-33	97	1957-58	242	1982-83	533
1933-34	103	1958-59	240	1983-84	450
1934-35	83	1959-60	278	1984-85	410
1935-36	113	1960-61	348	1985-86	434
1936-37	137	1961-62	298	1986-87	483
1937-38	145	1962-63	276	1987-88	528
1938-39	183	1963-64	269	1988-89	554
1939-40	214	1964-65	313	1989-90	597
1940-41	217	1965-66	254	1990-91	606
1941-42	231	1966-67	329	1991-92	610
1942-43	396	1967-68	347	1992-93	577
1943-44	137	1968-69	349	1993-94	533
1944-45	189	1969-70	384	1994-95	550
1945-46	180	1970-71	369		

Table 2. Number of Bachelor's Degree Graduates

Year	Students	Year	Students	Year	Students
1923	6	1948	35	1973	53
1924	14	1949	37	1974	64
1925	20	1950	63	1975	35
1926	19	1951	29	1976	65
1927	11	1952	17	1977	71
1928	12	1953	30	1978	62
1929	18	1954	13	1979	78
1930	10	1955	23	1980	85
1931	13	1956	33	1981	114
1932	7	1957	31	1982	106
1933	13	1958	35	1983	120
1934	18	1959	33	1984	100
1935	9	1960	29	1985	87
1936	12	1961	33	1986	72
1937	10	1962	33	1987	81
1938	6	1963	53	1988	82
1939	12	1964	27	1989	118
1940	12	1965	21	1990	128
1941	19	1966	37	1991	121
1942	17	1967	32	1992	117
1943	19	1968	36	1993	97
1944	6	1969	53	1994	101
1945	5	1970	42	1995	102
1946	5	1971	45		
1947	32	1972	57		

B. S. Graduates from Department of General Engineering

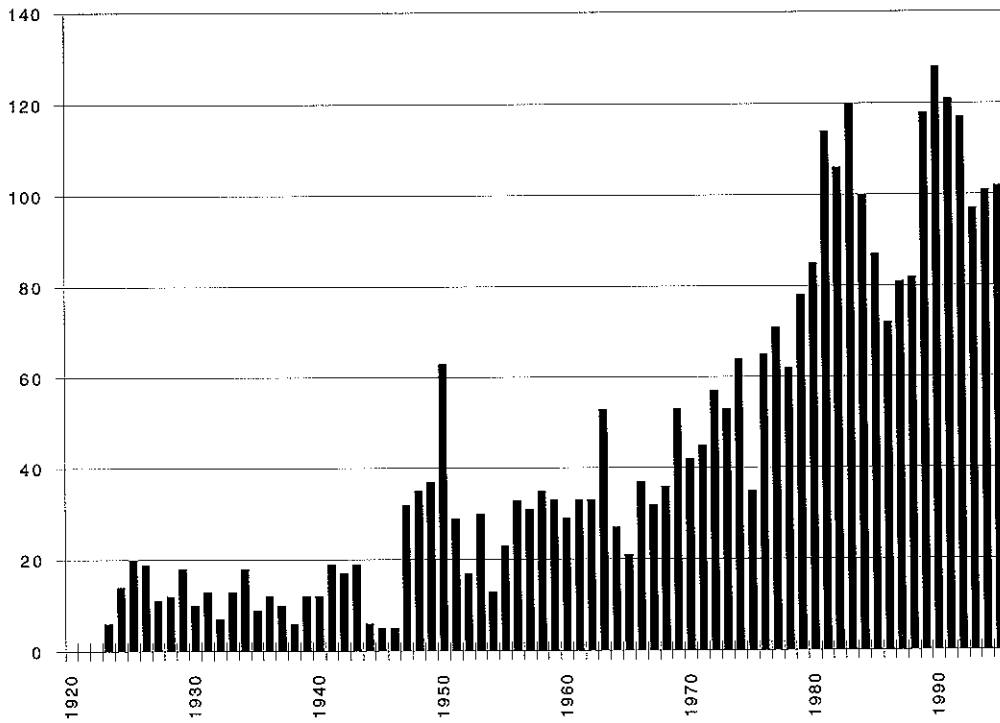

Figure 3

Fall Enrollment in General Engineering

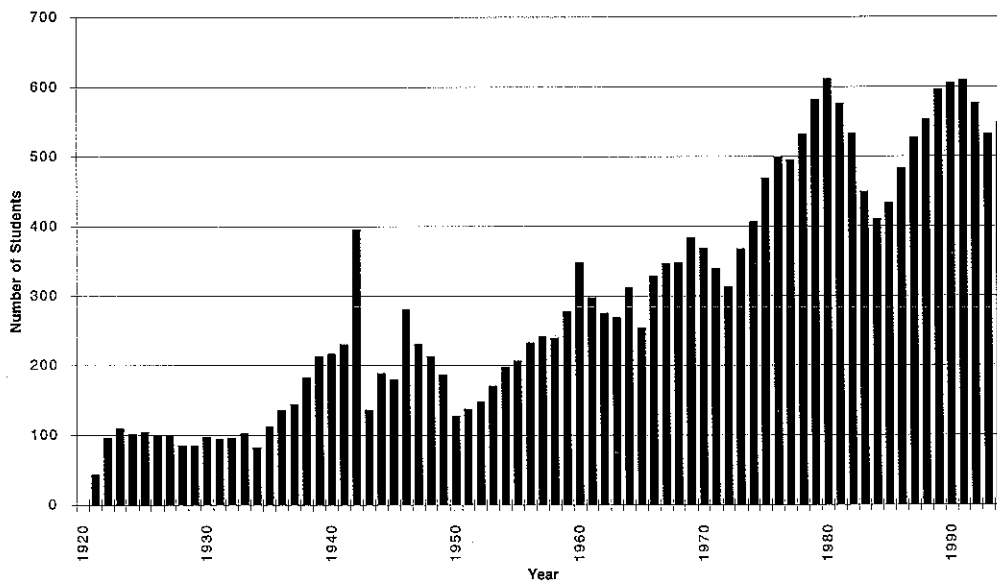
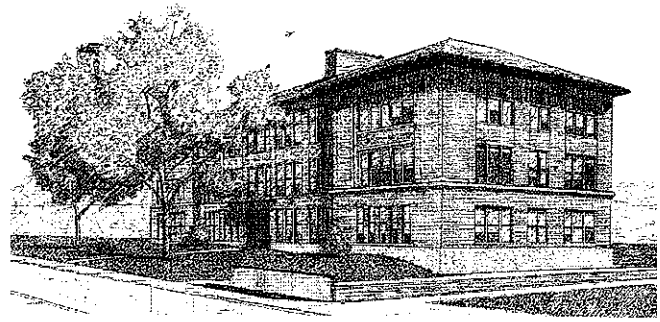

Figure 4



Chapter 3

Master of Science in General Engineering

Over the years, a significant number of the general engineering bachelors' degree graduates have gone on for advanced degrees. At one time, there were over 100 who obtained a law degree. Another popular program was the master of business administration. There were literally hundreds who went on for that degree. Several went on for medical degrees and became physicians.

The schools the graduates attended cover a wide range of leading institutions such as California Institute of Technology, University of Michigan, Harvard University, Massachusetts Institute of Technology, Stanford University, University of Wisconsin, Northwestern University, Rensselaer Polytechnic Institute, University of Miami, University of New Mexico, and University of Chicago. The percentage of graduates who went on to graduate programs ranged from 20% to 45%.

The Luke Report (page 17) of November 7, 1958, stated in one of its recommendations the following:

"The opportunities afforded the graduates of the department should be considerably enhanced by the attainment of advanced degrees. Since the development of graduate courses and staff represents a large undertaking, the department should aim toward the Master's degree as a maximum attainment for the next decade."

With the approval of the undergraduate courses in engineering design in September 1961, the faculty spent the next several years developing and teaching them. At the same time, a committee was appointed to develop a master's degree program in general engineering. The committee was chaired by John E. Pearson. On April 14, 1966, a proposal for the Master of Science in General Engineering was submitted to the College Policy and Development (CP&D) Committee.

A subcommittee of CP&D, chaired by Steven J. Fenves of the Department of Civil Engineering, raised a series of questions about the proposal in a memo dated October 20, 1966. One of the main concerns was who would be qualified to supervise the theses and special

problems. As of September 1959, none of the department's faculty had a PhD degree. At the time of the submission of the proposal in 1966, only Donald E. Sheck and Gordon E. Martin had their doctorates. Several others were about to complete the PhD; three other faculty had master's standing in the Graduate College.

Other concerns were raised about some of the graduate courses being submitted: who would be teaching them, the approach to design systems, and how they would be taught. After responding to these concerns, CP&D returned the proposal on December 1, 1966, with a number of questions regarding the teaching of engineering design at the graduate level. Recommendations were made by the CP&D subcommittee with a suggestion for resubmitting the proposal at a later date.

During this period of time, the American Society for Engineering Education (ASEE) was conducting a study on the goals of engineering education. In its April 1967 interim report on page 43, the following quotation provided additional support for the general engineering master's degree:

"It is recommended that more institutions undertake experimental Master's programs emphasizing design, new pedagogy, etc., because of too few of those now exist, compared to the extent of expressed interest."

In the final report of the goals study in January 1968, the need for experimentation at the master's level in engineering design was again repeated.

Upon the receipt of the December 1, 1966, memo from the CP&D subcommittee, the General Engineering Curriculum Committee went to work to incorporate the suggestions and to answer the questions raised. By December 14, 1967, the Curriculum Committee submitted a general outline of required courses, general engineering electives, technical electives, and sequencing to the faculty of the department.

A revised proposal was submitted to CP&D on February 6, 1968. This was again referred to the same subcommittee as before, namely:

Steven J. Fenves, chair, Civil Engineering
W. J. Hall, Civil Engineering
A. I. Ormsbee, Aeronautical and Astronautical
Engineering
W. R. Perkins, Electrical Engineering
Francis Seyforth, Mechanical and Industrial
Engineering

On March 11, 1968, a memo from the committee to the department head asked about design programs at other schools, the possibility of working with other College of Engineering departments, the ability of the general engineering faculty "to offer an M.S. program compatible with the academic standards of the University of Illinois," and the possibility of "a less-than-complete program at this time, say, consisting of a selected number of GE courses, combined with existing graduate courses in other departments."

On March 12, 1968, Dobrovolny responded with a strongly positive eight-page memo answering all of the concerns of the subcommittee. However, the proposal was again returned to the department on April 22, 1968, without approval. The report from the subcommittee did recommend the following alternate proposal:

"It is recommended that the General Engineering Department be encouraged to initiate an interdepartmental program covering as many departments within the college as possible. The program should initially consist of two parts: a) a series of cross-listed design courses, and b) a mechanism for M.S. thesis supervision."

Another factor that came into consideration was the fact that Dean W. L. Everitt was retiring and CP&D did not want to approve a new graduate program without the new dean being onboard. Dean Daniel C. Drucker was appointed in the fall of 1968 and came to the campus that November. His initial perception of the undergraduate curriculum was influenced by those in the College of Engineering who would have just as soon seen the demise of the general engineering curriculum.

In a memo to the department heads in early December 1968, Drucker made some damaging statements about the quality of students in general engineering. Dobrovolny immediately gathered from the Associate Dean's Office data breaking down the grade-point average by each class year for each curriculum in the college. In every case the general engineering students ranked first, second, or third out of 13 curricula. These data, presented at the next college Executive Committee, were persuasive and opened the eyes of the department heads and the dean.

Dobrovolny approached the dean about the master's degree program in general engineering in early 1969. After several months of frustrating meetings with Drucker, Dobrovolny submitted his resignation as department head in April 1969. Dean Drucker was shocked and refused to accept the resignation and asked how he could help the department pursue the master's degree.

After several meetings, Dobrovolny was able to have the dean assist in implementing the CP&D recommendations of April 22, 1968, that became to be known as the "umbrella program." Dobrovolny insisted that Drucker initiate a series of meetings with each department head to meet with him and Dobrovolny to discuss the implementation of the umbrella program. These meetings occurred in 1969, after which John E. Pearson, chair of the General Engineering Curriculum Committee, arranged a tailored program in each department of the College of Engineering in which the students would take some core courses and a project design thesis in the Department of General Engineering with the remainder of the courses in the respective departments.

The program was approved April 28, 1970, by Ross J. Martin, director of the Engineering Experiment Station, in a memo to Dobrovolny that reads as follows:

"I have reviewed the final draft of the cooperative graduate program for General Engineering and other engineering departments and hereby indicate my approval of this final draft. This is with the understanding that all departments concerned have reviewed those portions of the manuscript which deal with their joint departmental program.

I feel this type of educational activity is an effective way to introduce studies in design to our graduate program and hope this activity will meet with success."

The Graduate College approved the "umbrella" master's program in October 1970.

For the next three years the faculty of the department worked with various students in the umbrella program. In addition, several new faculty who had recently received their doctoral degrees were appointed. At the same time, the Curriculum Committee continued to work on a revised proposal to CP&D.

On February 12, 1973, the General Engineering Master's Degree Program was resubmitted to CP&D. After being reviewed by a subcommittee, the proposal was returned to the department on June 1, 1973, for revision. After extensive discussions with the CP&D subcommittee, the department submitted a revised version without sample programs on December 13, 1973. After additional discussions with the subcommittee, another revision was submitted March 29, 1974.

On April 1, 1974, the subcommittee unanimously recommended that the proposal be referred to the engi-

neering faculty for action. The subcommittee called particular attention to the following items:

"1. Faculty Qualifications

The General Engineering Department has utilized the Umbrella Program effectively in obtaining and developing young faculty members whose qualifications for conducting graduate teaching and research are quite consistent with the standards of the Engineering College. No significant further benefit will be realized by continuing the Umbrella Program.

2. Source of Students

While some cross feeding of graduate students will occur between the General Engineering Department and other departments, it appears that the bulk of the participants in the proposed program will consist of those students presently under the Umbrella Program plus students who would normally pursue graduate study in other colleges on this campus or in General Engineering at other institutions.

3. Nature of Program

Some difficulty of articulation is inherent in the definition of a design oriented program, however it is felt that proposed programs will serve an essential need on this campus and will complement existing programs. It is also felt that the existence of this program will have a salutary effect on the undergraduate program in General Engineering."

At the April 30, 1974, College of Engineering Faculty Meeting, the college faculty moved the following:

"Moved (Rowland) and seconded (Robinson) that the proposed General Engineering Master of Science Program be returned to the General Engineering Department, and that they be encouraged to proceed, in cooperation with appropriate departments, to develop viable programs for inclusion in the proposal, and that they be requested to resubmit the proposed program to CP&D as soon as possible along with complete formal course outlines for the 3XX and 4XX courses appearing in the proposed Master of Science Program."

A further clarification was provided with respect to the disposition of the action pertaining to the proposal and is stated in the minutes of the April 30, 1974, meeting as follows:

"The proposal is to be returned directly to the General Engineering Department and not through the transmitting committee; also in resubmitting the proposal it is to be sent to CP&D and not to the subcommittee which reviewed the proposal; and the example programs included in the proposal should have the endorsements of the cooperating departments."

From May 1, 1974, to April 3, 1975, the faculty members of the Department of General Engineering met with the respective faculty members from the various departments that had responsibility over areas of study that might possibly provide course work for some of the students that would be enrolled in the proposed Master of Science Degree Program in General Engineering. The faculty members that were identified from the other departments were those who had particular expertise in the related areas of study that would be supportive to a broadly based engineering design program as described in the proposed master's degree program. In the initial discussions with the chairman of CP&D and the mover of the motion of the April 30, 1974, college faculty meeting, it was interpreted that these sample programs were to be developed with the subject matter experts in the respective fields.

No interpretation was made at that time that these sample programs were to be channeled through the respective departmental curriculum or graduate committees because the proposed program is a Master of Science in General Engineering and not a cooperative or umbrella degree program. The faculty of the Department of General Engineering implemented the directions of the college faculty meeting and resubmitted the proposal, with the major change being in the revision of the sample program. In each case, the names of the faculty involved in the respective departments were listed at the bottom of the sample program.

On April 3, 1975, the proposal for a Master of Science Degree in General Engineering was again submitted to CP&D. This proposal included sample programs as well as the names of the 12 students who either had graduated or were about to get their degree under the umbrella program and their general engineering faculty advisers. Also included was a list of national student design awards received by general engineering students from the Lincoln Arc Welding Foundation and an incomplete list of other universities offering graduate degrees focusing on design. By this time there were eight faculty members with doctorate degrees.

On May 2, 1975, Dean Drucker sent a memo to CP&D and the Executive Committee of the College of Engineering outlining a brief history leading up to the proposal for the Master's Degree in General Engineering. Some of the items listed are as follows:

"5. Ten-year plans for the College were submitted on February 12, 1969 to (then) Vice Chancellor Herbert E. Carter which contained the estimate of a moderate number of GI students in General Engineering by 1980....

8. Once the decision was affirmed in 1958 that General Engineering was to remain an independent department the position was clear that subsequently the Department would have to develop a suitable graduate program leading to a master's degree. As soon as the Department had a sufficient number of qualified members of the professorial staff who were operating in a cooperative mode with the other departments, the only question remaining was when the independent master's program would start."

Therefore the May 15, 1974, Scope and Mission document of the University of Illinois for 1974-1980 contains the following paragraph:

"Engineering clearly is a 'relevant' activity in today's world, and the College recognizes a need to improve its interaction with industry and its service to State and local governments. An **undergraduate program in Nuclear Engineering (III)** and a **graduate program in General Engineering (IV)** will respond to some of these requirements through the traditional instruction mode. Research interaction with the most sophisticated industries has been very successful but much more remains to be accomplished in mutual interaction with some of the more mature industries that provide the economic backbone for the State of Illinois."

A steering committee was appointed to assist the department in presenting the proposal in the Illinois Board of Higher Education format. The committee members were:

- C. E. Bowman, Theoretical and Applied Mechanics
- T. F. Conry, General Engineering
- R. E. DeVor, Mechanical and Industrial Engineering
- L. D. Metz, General Engineering
- W. R. Perkins, Electrical Engineering
- S. L. Soo, chair, Mechanical and Industrial Engineering

On October 14, 1975, the committee reported to Dean Drucker a unanimous recommendation for the proposal. On February 24, 1976, Drucker sent the proposal along with a number of appendices to the faculty of the college. In his cover letter, he closes with this statement:

"I am pleased to commend to your attention this carefully drawn document which is the culmination of so many years of discussion and planning."

At the March 9, 1976, College of Engineering Faculty Meeting, the proposal was approved and forwarded to the University Senate Educational Policy Committee. This represented a 10-year effort on the part of the general engineering faculty.

At the Senate Educational Policy meeting at which the proposal was considered, several critics from the College of Engineering faculty appeared to speak against the proposal. Drucker was there to support the program. In a March 25, 1977, memo to Dobrovolny, Rollin G. Wright, chair of the Senate Committee, wrote that the proposed Master of Science Degree in General Engineering was approved and was being presented at the April 11, 1977, Senate meeting. The program was approved at that meeting and forwarded to the Board of Trustees, who approved it on May 18, 1977. The Illinois Board of Higher Education approved it on December 6, 1977.

Thus ended a 12-year effort of perseverance and constant resistance from faculty of the other departments in the College of Engineering. The support for this program by Dean Drucker was strong and without it the program might never had been approved.

The next step was to prepare a brochure and advertise the existence of the new master's degree. The first student was admitted in the fall of 1979. He was Bradley D. Mottier. He graduated in January 1981. Closely behind him was John B. Holz, admitted in the spring 1980 and graduated in May 1981.

In the proposal it was projected that there would be 35 students enrolled within five years.

Table 3. General Engineering Master's Enrollments and Degrees

Calendar Year	Fall Enrollments	Number of Graduates
1979	4	0
1980	7	0
1981	12	2
1982	19	3
1983	20	6
1984	22	5
1985	18	15
1986	21	10
1987	26	11
1988	34	11
1989	31	7
1990	31	20
1991	34	12
1992	37	11
1993	42	14
1994	45	13
1995	31	11
Total		151

Joint MSGE/MBA Program

A large percentage of the department's students have elected to pursue a secondary field in engineering management or engineering marketing. After graduation, many have gone on for a master of business administration (MBA) degree, either right after graduation, or later while working in industry.

As the enrollment for a master's degree in general engineering (MSGE) increased, a number of students selected several elective courses in the College of Commerce and Business Administration. This provided the impetus for a committee headed by Thomas A. Conry to investigate the possibility of a joint MSGE/MBA program. The normal MBA program requires 18 units (72 semester hours), while the MSGE requires 8 units (32 semester hours). The joint program satisfies both degrees, because the MBA program permits the 6 units of GE work to fulfill its requirement of 6 units of elective, and the Department of General Engineering accepts three of the MBA core courses to fulfill three electives in its degree program. Thus, the joint degree requires only 18 units of course work, when independent MSGE and MBA degrees would require a total of 26 or 27 units for the thesis and project options, respectively.

The Program

Normally, students admitted to the program have fulfilled all MSGE and MBA prerequisites through demonstration of coverage of the necessary prerequisite course material at an accredited school. Students with deficiencies in program prerequisites can satisfy them by passing proficiency examinations covering the material of these courses or by completing the courses or their equivalent for no credit while enrolled in the joint program.

The joint program requires a total of 18 units: 12 units of MBA core courses, 4 units of courses toward the MSGE requirements, and 2 units of GE thesis or project work. The 12 MBA core courses (one-unit each) are as follows:

Fall

ACCY 401	Financial Accounting
ECON 422	Microeconomics for Business
BA 420	Marketing Management
BA 472	Modern and Classical Statistics for Management Decisions
BA 409	Organizational Behavior

Spring

ACCY 403	Managerial Accounting
ECON 423	Macroeconomics for Business
FIN 451	Financial Management
BA 473	The Quantitative Analysis of Decisions
BA 467	Production Management

Remaining

BA 443	Legal Aspects of Management Decisions
BA 444	Policy and Planning

Normally, the first 10 units will be taken in lock-step; however, if a student has a research or teaching assistantship (and these will be limited to 0.25 time), no more than 4 units can be taken each semester with the remaining units to be made up in subsequent semesters.

Four units of course work consistent with the department's normal MS degree requirements are required. These are chosen with the approval of the Department of General Engineering adviser:

GE 4xx	Any approved 400-level GE courses (not GE 493)
GE3/4xx	any 300- or 400-level GE course (can include GE 393/493)
xx 3/4xx	Technical (engineering, math, etc. —not business) elective

Two units of project/thesis work are required, and because the critical path usually runs through this requirement, students are well advised to determine a suitable project and project adviser in the first semester of the joint program. If the project option is chosen, two units of GE 497 are taken. If the thesis option is chosen, one unit of GE 493 is taken as an independent study in preparation for thesis work. This is followed by one unit of GE 499, Thesis.

Project and thesis work are open ended and will usually require effort during one or both summers. An aggressive student who gets a project lined up early in the program conceivably can get the lion's share of the project completed in the first summer, thereby permitting the degree to be completed in four semesters plus one summer.

Off-Campus MSGE

On July 14, 1993, the vice president of academic affairs announced the initiation of a three-year sequence of courses leading to a master's degree. This was to be done through the Office for Advanced Engineering Studies in Rockford, Illinois. The original areas were in mechanical engineering and theoretical and applied mechanics. The courses were offered via Electronic Blackboard. In 1985, the program was expanded to include electrical engineering and general engineering.

In addition to the Electronic Blackboard, presentation courses also were taught by professors traveling to various sites throughout Illinois.

Chronological List of Master's Degrees Awarded in General Engineering

1981

Bradley D. Mottier III
John B. Holz

1982

Ronald L. Radloff
Gregory S. Gerard
Steven J. Stubitiz

1983

Bernard L. Cyr
James F. Gerber
Scott A. Jennings
Keith R. King
Timothy L. Warol
Sharon M. West

1984

Richard T. Cartwright
William J. Hayes
Paul J. Henkels
Brian P. Lilly
John R. Regan

1985

Oscar R. Adriolzen
Kaan R. Aytogu
Daniel J. Bitz

Susan C. Bowen
Paul N. Garcy
Joseph A. Jaegar
Alan E. Landman
James A. Muenzenberger
Luela M. O'Neil
Robert A. Plotke
Jon W. Pollack
Andre J. Quattrachi
Virginia A. Shea
Larry R. White

1986

David L. Bectzel
David M. East
Timothy L. Filbert
Robert B. Goldman
Barry M. Hare
Cynthia A. Kaminsky
Paul L. Keane
D. Michael McFarland
Paul H. Verstrate
Marion I. Wu

1987

Terry W. Anderson
Edward J. Dougherty
Matthew F. Fonk
John D. Gardiner
Mathew L. Grisey
Cynthia A. Kalina
William L. Lenzi
Gonzalo Perez
Lavra Jean (Lavering) Thiel
Mary A. (Bitz) Widing
Daniel E. Williams

1988

Kimberly K. Adams
Stephen M. Dowd
Eve K. (Sierocki) Hastings
Robert A. Leland
Janice E. (Mueller) Lilly
Timothy J. Moore
Eric D. Oden
William A. Scheid
John A. Shonder
Michael H. Simmons
Harry S. Wildblood

1989

Fredrick W. Jewell
Mathew A. King
Kurt L. Koenig
Vladimir V. Kokotovic
Jose C. Lopez-Dominguez
David N. Slowinski
Thomas W. Tirpak

1990

Andrew D. Aswad
Dean A. Brusnigham
Michael J. Chid
Jose Colucci, Jr.
Christopher A. Crawford
Robert L. Ericson
Robert D. Flanigan*
Ethan T. Franklin*
Eric P. Hedlund
Chang-An Hsien
Jacquelyn S. (Beller)
McGroderly
Kent A. Miller
Andre Pavkovic
Michael J. Safoutin
Margaret A. Schneller
Richard F. Sesek
Robert M. Sesek
Shawn M. Sowers
Joel W. Stockman
Peter L. Webster

1991

Rudi L. Bogaerts
Ronald J. Borre, Jr.
Jim K. Carroll
Spiro J. Deligiannis*
Lisa M. Dullum
Seth W. Fanders III
Craig A. Lins
Shelley K. Morgan*
Stephany E. Siwinski
Yuni Tian
Kris A. Warmann
David T. Watanabe*

1992

Tony M. Carr
Alan J. Fitzmorris
Julie A. (Furmanek) Jewell
Lara Ann (Antoniacci)
Maier
Alyce M. Nogal
Scott P. Orr
Mark J. Orth
Mark A. Raschke
Yihchith Shern
Tim D. Stuart
Milorad D. Sucur

1993

Tony W. Benzinger, J.*
Scott W. Bonnett
Scott K. Essington*
Elizabeth W. Fikes
Gregory R. Kopp
Stephen L. Lesniak*
Mauricio A. Lopez*
Jerome A. Maloney
Kevin R. Manley*
Brian L. McKay
Rajini H. Ragavan
Michael A. Scott
Douglas L. Waco
Robert E. Whitney*

1994

Leslie B. Arney
Sassan Attari
Nilda L. Barreiro
Bradley C. Bauman
Victor Izokaitis
John P. Keagle
Joseph G. Macro
Mark Maslov
Michael W. Orlet
Ryan K. Rounkles
Jeffrey D. Rowe
Edward L. Spellman II*
Michael Z. Yuan

1995

Joseph D. Dehaai*
Phoebe E. Lenear
Rodrigo A. Marin
Sreekumar Menon
Aaron R. Rogers*
Jason R. Sagan
Yirhan Sim
Troy S. Torbeck
Scott V. Vifquain
Qun Ziao

*Joint MSGE and MBA

Chapter 4

Computer-aided Instruction and Laboratories

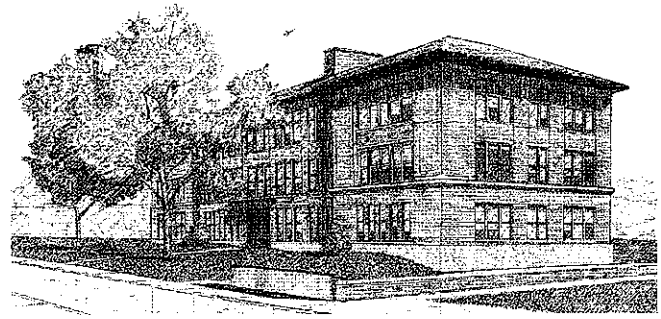

In the 1960s and 1970s, the use of computers in industry and in government research agencies was done by a relatively select few research institutions using large main frame computers. This period of time coincided fairly well with the development of the integrated engineering design sequence of courses in the department. The Department of General Engineering was an early leader in introducing the use of computers in computer-graphics and computer-aided design (CAD). As early as 1966, Ronald J. Placek and Michael H. Pleck (joined the department in 1970) developed computer plotting routines for the display of transformations of gear teeth profiles into half spaces. Bernt O. Larson, chairman of GE 242, Senior Project Design, attended a 1968 seminar program on computer-aided design sponsored by NASA-MSU at the University of Houston.

The department was one of the early innovators in the pursuit of introducing the use of computer-aided instruction. In 1968, Pleck developed and implemented the methodology to introduce computer graphics in GE 103, the freshman engineering graphics course. The methodology consisted of two digital programs with supportive instructional material and user's guides: GRAFIX, a special user-oriented language program for conventional drafting (including oblique and isometric drawings) and GATRAN, a FORTRAN IV program for the modeling and viewing of three-dimensional constructs to aid in spatial visualization. These early programs required punch cards to be fed into the mainframe computer. In the fall of 1969, the computer graphics program was expanded to be used in six sections of GE 103. In 1970, all GE 103 sections were involved with computer graphics.

In 1969-71, Pleck offered a one-hour Engineering Honors Course, Eng.H. 297, to investigate the use of computer graphics on the then present-day computers such as the IBM 7094/CALCOMP Plotter System for computer graphics. In it, he used the in-house plotter-based engineering program GRAFIX. It used the campus main frame computers (IBM and later the CYBER) and CALCOMP plotters. But its drawback was the need

to sometimes wait several days to get the graphic output generated from line drawing instructions.

In July 1970, the department purchased an EAI-580 stand-alone analog hybrid computer. Louis Wozniak introduced its usage in simulating dynamic systems in various courses such as GE 222. It was also used in various graduate research projects.

In 1970, Pleck and Roland L. Ruhl developed the Illinois Graphics Computing System (IGCS), a research and development program. The work was done with the cooperation of C. W. Gear of the Department of Computer Science. The goal was to provide low-cost, on-line, hands-on computing for in-class undergraduate graphics, simulation, and design education. For the first time, IGCS provided a high-performance, stand-alone, hardcopy graphics computing system for under \$50,000. The hardware configuration of the total system is shown



Professor M. H. Pleck (standing) and graduate student D. D. Burn test a new line printer driver for the PDP-11/20-Gould 800 electrostatic raster plotter. This driver was an integral part of the engineering graphics program being developed on minicomputers in 1974.

FIXED HEAD DISK
(256K words, 16µsec/word transfer, 17 msec average access time)

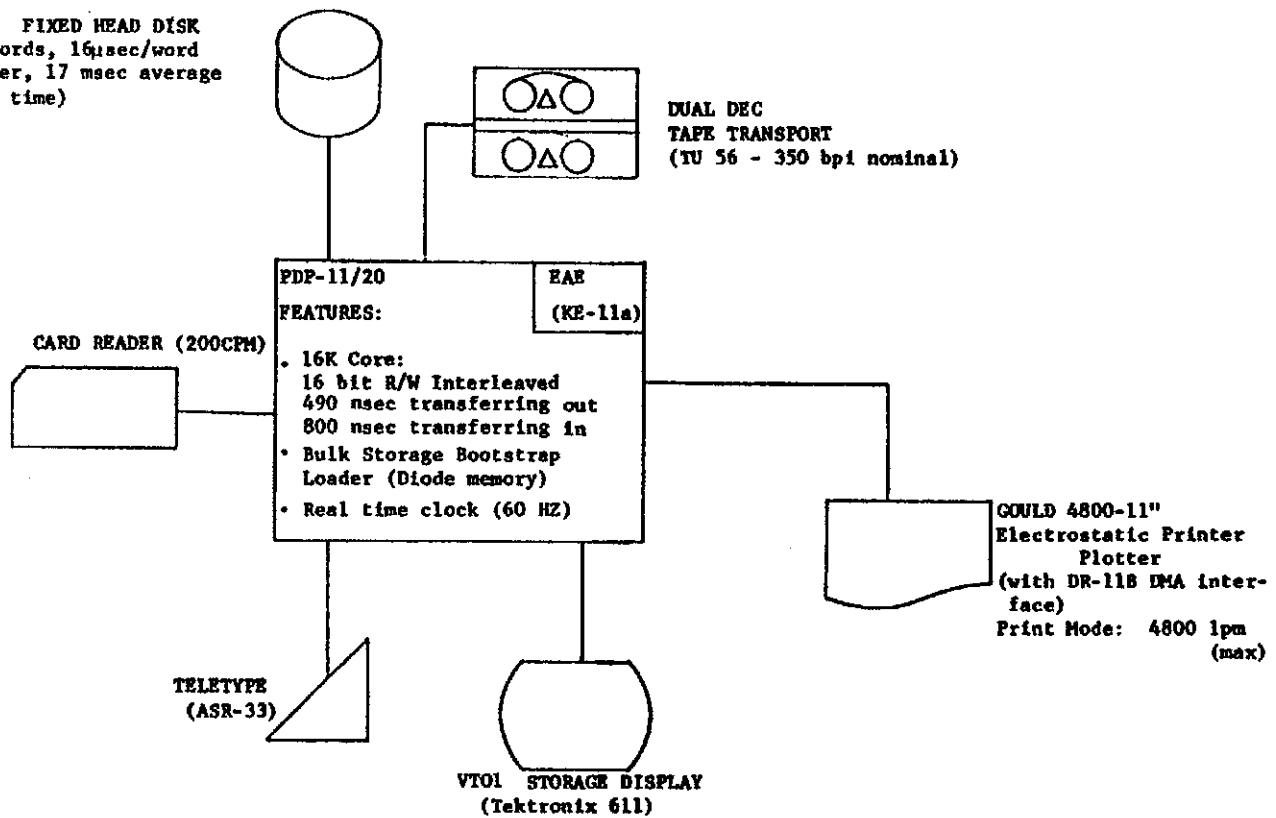

Figure 5

in Figure 5. They received a grant from the Ford Foundation for a summer research project in 1971 for the integration of an electrostatic printer/plotter (Gould 4800-11) with the PDP-11/20 for the IGCS system. They continued the development of computer graphics instructional programs for the departmental design sequence using CSO IBM 360/75 and the Calcomp plotter.

In 1972, Pleck and Ruhl, using funds from the Ford Foundation engineering design grant, acquired a Digital Equipment Corp. PDP-11/20 stand-alone minicomputer. This represented a state-of-the-art breakthrough for the department in providing direct designer-computer interaction, a concept now standard. They were called upon by various national user groups to present papers on the IGCS program.

In an effort to interact with the rest of the user community, primarily on campus, IGCS facilities were made available to a number of outside parties on an as-available, no-interfering basis. The Department of Electrical Engineering's Radiolocation Research Laboratory used

IGCA for assembly language program debugging prior to trips to its PDP-11 field sites surrounding Champaign. In a cooperative project, Bruce Holecek, a graduate assistant in the Department of General Engineering, and Ken Poole, a research associate with the National Clearinghouse for Correctional Programming and Architecture, the Department of Architecture initiated the use of the IGCS system for on-line correctional facility cost estimating. The particular suitability of IGCS to their methodology provided them with the opportunity to see their project reach a swift and successful conclusion.

In 1972-74, Pleck introduced integrated computer-aided design using the finite-element analysis program, STRUDL, to introduce structural design in the GE 221 course.

In the spring and summer of 1980, Pleck was granted a sabbatical leave to go to Cornell University and Hokkaido University in Sapporo, Japan, to further his expertise in computer-aided design. He brought back with him the Technical Information Processing System (TIPS-1) computer program. This background enabled this program to be used in senior design projects and graduate student research projects.

Early CADD Activities

In 1980, a \$47,000 grant from General Motors Corp. enabled the department, with the cooperation of the Department of Aeronautical and Astronautical Engineering, to establish a Computer-Aided Design Drafting (CADD) Laboratory. The laboratory had the interactive computer terminals listed below linked directly to the university's Control Data Corp. CYBER 174 and 175 mainframe computers:

- 2 - Tektronix 4010 terminals
- 1 - Tektronix 4014 terminal
- 1 - Tektronix 4114 terminal
- 1 - Tektronix 4631 hard copy unit.

This equipment was used to increase the interaction of CADD-based GE 103 engineering drawings. The graphic output appeared within seconds as opposed to the previous methodology.

The primary software used in the CAD/CAM activity consists of GIFTS-5 and TIPS-1. GIFTS-5 is a finite element based analysis package applicable to structural and mechanical problems in an interactive graphics mode. TIPS-1 is a geometric modeler based CAD/CAM system consisting of definitional, analysis, and manufacturing subsystems. Both were integrated into the department's instructional and research programs, providing state-of-the-art knowledge to students entering the design and manufacturing industries. The implementation of the CAD/CAM laboratory was guided by Thomas F. Conry and Pleck.

In 1982, through Conry's efforts, the Evans and Sutherland Corp. donated a \$88,645 PS 300 graphics system, which was added to the laboratory. The Evans and Sutherland PS 300 was used to develop a truly interactive version of GATRAN, one that permitted dynamic movements. This projection model served as a demonstration tool for small groups brought to the laboratory.

IBM 4341 CAD-CAM Laboratory

In 1981, the Department of General Engineering made a proposal to IBM Corp. for CAD/CAM equipment to be used by the departments of General Engineering and Aeronautical and Astronautical Engineering in their upper division and graduate engineering design courses. This proposal was one of several generated by the university to IBM in 1983 that resulted in the award of a \$2 million grant by IBM on June 21, 1983, of an IBM 4341 CAD/CAM system and associated peripherals, including 17 graphics workstations and several CAD software packages. Nine of the graphic workstations were IBM 3268 black-and-white vector graphics devices and eight were IBM color raster graphics devices. The donated system could only be used for CAD/CAM instruction, and research in CAD, finite element analysis, interactive graphics, modeling, etc. It could not be used for direct sponsored research or administrative services. In

addition to the new IBM terminals, the Tektronics terminals were able to be connected to the new main frame IBM 4341. IBM made similar grants to 21 other universities. Representatives from these grant universities met yearly from 1984 to 1986 to report on the usage of the 4341 CAD/CAM system. Scott A. Burns (joined the department in 1985) and Michael H. Pleck were the University of Illinois representatives to these meetings. In the implementation of the grant, Harry H. Hilton, professor of aeronautical and astronautical engineering, worked closely with various members of the department.

The CAD laboratory is located at two sites, the Transportation Building and the Mechanical Engineering Building. Both are connected via high-speed links to the IBM 4341 computer. The laboratory became operational in 1984 and was limited to four departments: Aeronautical and Astronautical Engineering, Civil Engineering, General Engineering, and Mechanical and Industrial Engineering.

In the Department of General Engineering, hands-on instructional use was made in the following courses:

- GE 221 Introduction to General Engineering Design**
Use of the Static Analysis of General Structures (SAGS) subprogram of CAEDS and its corresponding plotting programs (SAGSPL) were being undertaken. Planar truss and frame analyses were performed, augmenting prior activity with ICES-STRUDL. Interactive modeling was soon added to the student-use repertoire.
- GE 222 Analysis of Dynamic Systems**
The dynamic simulation language (DSL) was incorporated into the course activity, replacing ACSL, because of its ability to provide frequency domain analysis. A lack of desirable high-resolution graphics capability on IBM 3279 terminals had to be resolved.
- GE 241 Component Design**
The frame analysis package of CAEDS was used to determine internal behavior of complex three-dimensional frames. This provided the basis for the design of the component members and connections of the frames.
- GE 242 Senior Project Design**
CADAM and CAEDS were used by design project teams in a variety of modeling design applications requiring FEM analysis. In addition to these specific courses, activity was undertaken by several students in GE 393, Independent Study, to explore additional use of the grant system in a junior level design course, GE 232. This use was focused upon the creation and manipulation of finite element meshes.

Project EXCEL Laboratory

It soon became clear that the IBM 4341 CADD laboratory could only be available to a limited number of upperclass students. In November 1983, the department requested funds for a computer-aided design drafting laboratory for use by freshman engineering students taking GE 103. The laboratory was to consist of 24 workstations built around microcomputer terminals. Discussions Michael H. Pleck and Thomas R. Woodley (joined the department in 1980) had with IBM about this need helped generate an interest by IBM that resulted in a grant to the university of \$12 million known as Project EXCEL (Excellence in Computer-Aided Education and Learning). In the summer of 1984, the Department of General Engineering received one of the first 10 awards under Project EXCEL. As a first part of the grant, IBM provided 8 IBM PC-XTs that were installed on the fourth floor of the Transportation Building in a new room.

During the first semester of 1984-85, with only six PC-XT workstations available, exploratory work was done with students enrolled in the honors section of GE 103, Engineering Graphics. This enabled Pleck and Woodley to install and use IBM PC-cluster networking hardware and AutoCAD software.

By the second semester of 1984-85, IBM had provided its new expanded hard-drive equipped PC-ATs. It gave the department 30 of the new PC-ATs along with the IBM PC-NET software. This was a network that allowed all of the PCs to be integrated into the network using the AutoCAD computer graphics program.



The Micro-CADD Laboratory, 1986.

Woodley and Pleck developed many innovative teaching procedures with this system. One of these was a methodology whereby the drawings the students generated on their discs would be graded semiautomatically on the PC-NET. Figure 6 illustrates some of the output of the microcomputer-aided design and drafting systems in use in the engineering graphics course, GE 103, with the Project EXCEL equipment and software. Both professors were called upon by many companies, including IBM and AutoCAD, to present seminars on the innovative procedures they had developed. In the period 1985-88, several one-week state and national workshops were conducted at other universities.

Educational Impact

The educational impact of the project was assessed by internal and external qualitative and quantitative evaluations. The first large-scale quantitative comparison occurred during the second semester of 1984-85. This involved the use of 8 sections of GE 103 in paired test and control groups of about 70 students in each group. The students were assigned to the control or test group by random selection while maintaining balance of gender, academic level, and academic major. Additionally, even instructor experience, rank, and reputation for teaching skill were balanced for the paired control and test sections.

Four sections were taught by the traditional graphite manner and four sections used minicomputers with AutoCAD software. The parallel sections were tested identically and simultaneously using only the pencil and paper mode. The outcome was higher average scores by the micro-CADD test group on quiz and exam questions in all pertinent topic areas except one.

In a smaller subsequent study, records were kept of the times needed by a small group of students to complete similar assignments using the micro-CADD and graphite approaches. It was found that in almost all cases the average time was 5 to 45% less for the micro-CADD approach, even if the first exposure to a topic assignment was with micro-CADD. The paired sections concept was repeated with a total student base of 768 — divided evenly between test and control groups. Results were even more favorable.

Testing aside, staff members observing student performance and attitudes have concluded that the students in the micro-CADD groups seem to be learning more, learning better, and learning faster than by former methods. This was particularly evident in situations where anomalous results of micro-CADD algorithms were not only noticed by students, but dealt with effectively. In addition, students in the micro-CADD sections showed the willingness to put an extra effort into their work and take pride in the results, traits noticeably lacking by comparison in the control group and students of prior years.

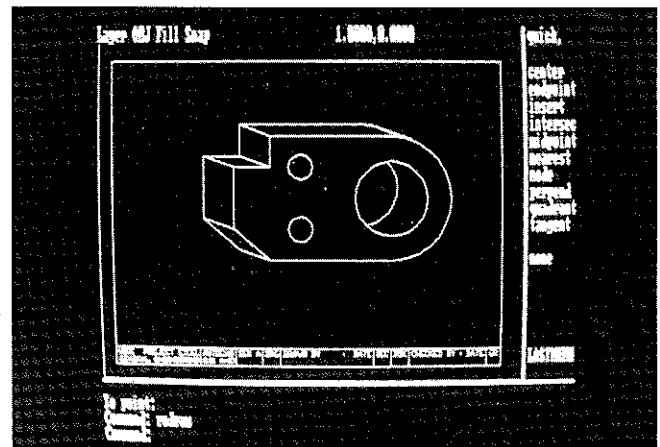
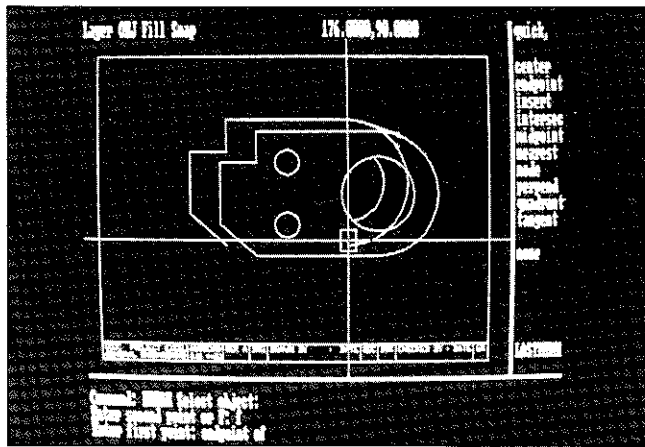
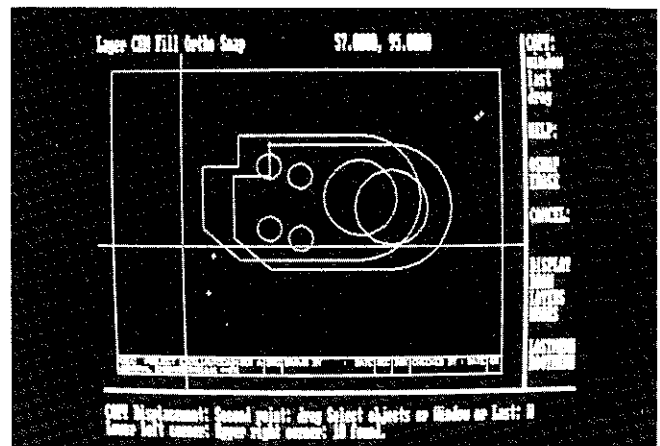
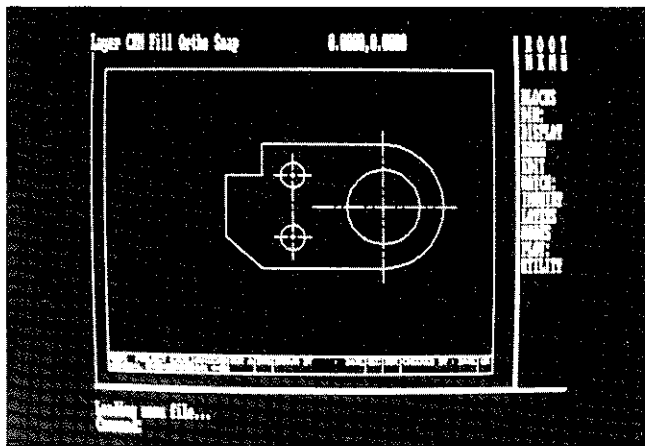

Figure 6

From 1985 to 1987, attitude surveys were completed by students at the end of the course. The preliminary analysis of these collected data has yielded some interesting observations. Most important, micro-CADD-trained students did not perceive how much better they were performing than their traditionally trained peers. Second, their enthusiasm had no noticed correlation to performance. However, students who had manual EDG training prior to the course were less enthusiastic but performed notably better than the norm; those who had prior computer experience were more enthusiastic but did not perform noticeably better. Third, students favored CADD more for complicated problems than simple ones. Finally, the average section response on each question seemed to parallel the response made by the section instructor.

External Impact

The work of Pleck and Woodley has extended beyond the University of Illinois at Urbana-Champaign. They have given numerous presentations on the UIUC campus to visiting academics from both junior colleges and four-year institutions and have presented their work

at many American Society for Engineering Education (ASEE) and other conferences. Further, in 1988, they presented a short course, sponsored by the National Science Foundation, in which engineering graphics instructors from many schools across the nation were selected to attend. This course provided a presentation of the instructional system used at UIUC, and also provided an opportunity for sharing of ideas, methods, and procedures among the short course participants. In 1989, one year later, as part of the NSF-sponsored project, the participants from the previous year were invited to return to the campus to review the previous year's work in course and program development at their home institutions. Needless to say, the work of Pleck and Woodley has had an impact on many institutions of learning in the United States. A number of letters received attest to this. In essence, their methods showed that it is possible to join a microcomputer hardware system and commercially available software into a usable and reasonably

affordable system for education of engineering students in engineering design graphics. The overall impact of this work is that students are able to learn faster and more efficiently and as a side benefit are introduced to the rudiments of computer-aided design and drafting and computer-aided design systems which they will see later in their engineering education and as they go on to industry.

It also became apparent that a more efficient way had to be developed to present the material to a larger number of students. Therefore, in the summer of 1985, one of the existing engineering graphics laboratories was converted into a 100-seat lecture room with a 100-inch high-resolution screen to display the output of a normal CRT screen. This way, the operational aspects of the microcomputer-based software (AutoCAD) were demonstrated to the students without having to explain on a one-to-one or small group basis when the students went to work at their individual workstations. The 100-inch screen was tied into the network with the 30 workstation laboratory.

However, for the 1985–86 year, the PC laboratories could only accommodate half of the students taking GE 103 during the first semester. The other half had to be taught the standard graphics method. Not only were the students demanding to be enrolled in the computer presentations, but the test results showed a marked improvement from those taking the computer-based approach.

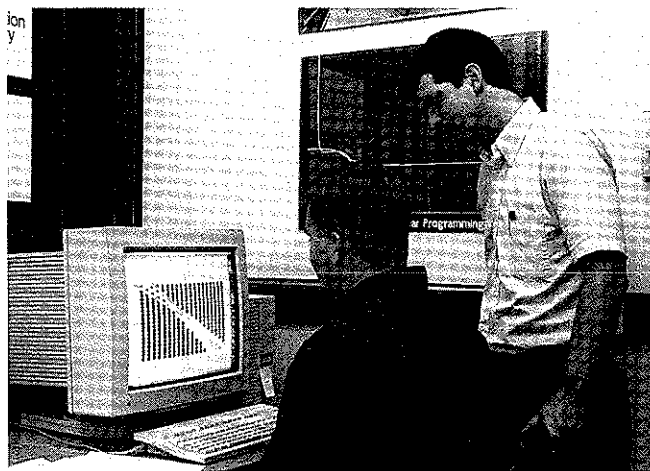

In the Algorithm Visualization Laboratory in 1995, Professor Scott A. Burns discusses a monomial-based method for solving systems of algebraic with graduate student Keith Mueller.

The original IBM Project EXCEL grant provided \$335,370. The campus provided \$44,900 for non-IBM equipment and graduate assistants. The college provided \$24,000 toward the licensing of the AutoCAD software, as well as the \$80,000 for the renovation of the necessary classrooms for the project. The total for the first year of the project, including departmental funds, was \$575,496. This does not take into account the costs of faculty release time to implement the project.

During the second year (1985–86), the department received \$93,025 for IBM equipment and software support and \$60,825 from the campus. In the third and final year (1986–87) of Project EXCEL, the department received \$22,290 from the IBM grant for equipment and software, \$49,000 from the campus, and \$25,000 from the college.

Early in 1986, Pleck developed a proposal presented to the Zenith Data Systems group to expand the use of computers in GE 103, Engineering Graphics, so all of the students could use the personal computers. Contact was also made with Hewlett-Packard Co. and IBM for the additional equipment. On May 7, 1986, a grant was received from Zenith Data Systems for 13 workstations at a value of \$43,600. The college provided \$85,000 for purchasing 15 additional workstations and remodeling room 303 in the Transportation Building for the second CADD laboratory. The second laboratory was operational for the first semester of 1986–87, thereby enabling all the GE 103 sections to be taught with the personal computers.

A summary of the grants for Project EXCEL is listed in Chapter 5, Grants and Research Funding.

Algorithm Visualization Laboratory

The Algorithm Visualization Laboratory (AVL) was established in 1992 in the Department of General Engineering under the direction of Scott A. Burns with the support of a Presidential Young Investigator Award from the National Science Foundation and an equipment grant from Apple Computer, Inc. The mission of the laboratory is to investigate global behavior in a useful and systematic way.

Numerical methods are used extensively in engineering to solve problems that cannot be solved in closed form. Many of these numerical methods are embodied in an iterative algorithm, such as Newton's method for finding solutions of nonlinear equations. Although we understand well how such methods operate, it is another matter to understand how they behave in general. Simple numerical methods applied to simple engineering problems have been found to exhibit extremely complex numerical behavior which becomes visually evident when visualization techniques are used to portray the behavior.

The AVL has developed a software package called BasinsLab, which enables investigators to generate visualizations of specific engineering applications and numerical solution techniques. BasinsLab is primarily a research tool—it can be used to compare and contrast the behavior of different numerical methods applied to the same problem, or to investigate the range of behavior that is encountered when a specific method is applied to a variety of different problems.

Microprocessor /Controls Laboratory

In preparation for an ABET accreditation visit in 1983, it became apparent to the department that there was a lack of laboratory course work in curriculum. To satisfy the lab requirement, a 3-semester hour course, GE 234, General Engineering Laboratory, was designed in 1982 to meet the special needs of the curriculum. The topics covered included use of mechanical and electrical instruments, basic measurement techniques, simulation of dynamics systems, application of microprocessors to control problems, measurement errors, mechanical properties of materials, transducers and signal conditioning. The lab was originally located in 308 Transportation Building. In 1986, it was moved to room 302, and consisted of Apple IIe workstations with associated instrumentation. Later on, in 1988, the lab was moved to 402 Transportation Building. In 1989, the equipment was replaced by IBM PC-compatible 286 and eventually IBM 386 workstations and continued to be used for GE 234 and GE 324, Digital Control of Dynamics Systems. In 1994, this lab was moved to 216 Transportation Building.

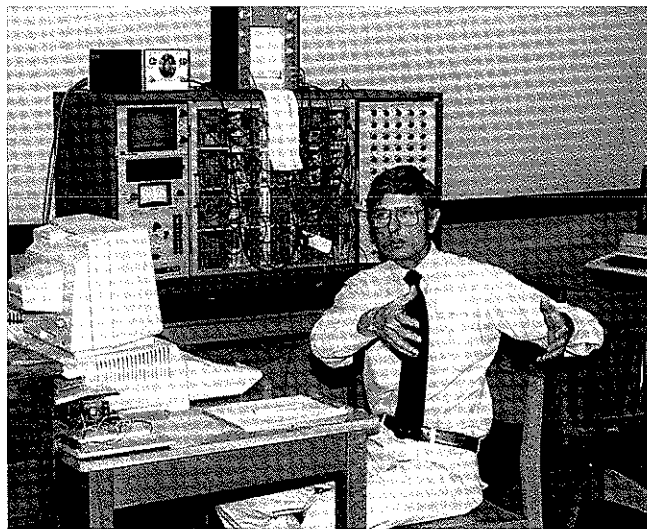

Professor Louis Wozniak in the Analog Systems Laboratory, 1982.

Computer-aided Engineering Design Laboratory

As the Controls Laboratory moved out of room 302, a new laboratory was established with 30 MAC II workstations, a file server, 2 MAC Se computers, and 2 laser writer printers. The equipment was obtained from Apple on a matching basis: for each unit purchased, Apple donated one. The lab is under the direction of Scott A. Burns, and is used to teach finite-element analysis in GE 221, for frame and truss analysis in GE 232, for structural analysis, and in the senior design course as needed. It also is used in GE 493, Engineering Design Optimization.

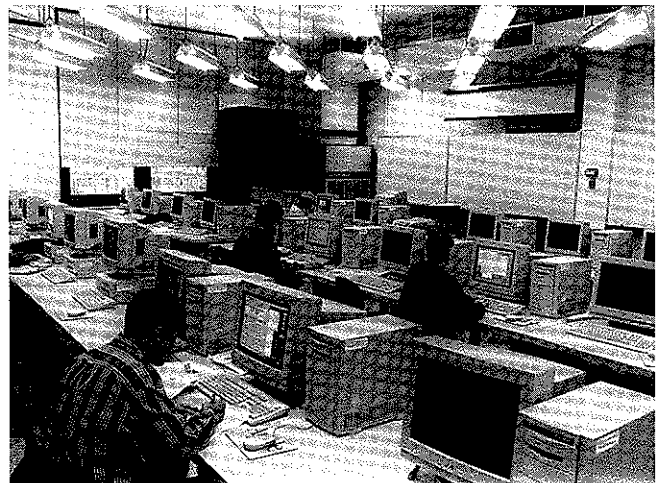

Computer-aided Engineering Design Laboratory, 1995.

Robotics and Automation Laboratory

The interest in robotics in the department can be traced to 1976 when Rodney D. Hugelman joined the faculty. Prior to coming to the department, he had been employed by the General Progress Corp., Rockford, Illinois, where he had patented a low-cost fluidic robot. When Mark W. Spong joined the faculty in 1984, he had taught courses in robotics at Cornell University. It was only natural that his background provided the impetus for moving in the direction of establishing a robotics laboratory and a course in robotics.

During the spring semester 1986, Spong developed a new course, GE 389, Robot Dynamics and Control. The department had obtained two robotic workcells, each consisting of a Rhino robot, controller, teach pendant, and a computer workstation. Room 402 was set aside as a robotics laboratory. On March 4, 1986, Spong and Hugelman sent a memo to Department Head Dobrovolny, seeking to expand the laboratory. The plan consisted of purchasing five additional robotic workcells and to be operational for the fall 1986. On May 19, 1986, a request was made to the College of Engineering Manufacturing Engineering Committee for \$44,461. This request was forwarded to the University Research Board and the College of Engineering for funding.

In June 1986, Hugelman, Spong, Thomas Woodley, and Louis Wozniak met and proposed to Dobrovolny the establishment of a robotics laboratory in 316 Transportation Building.

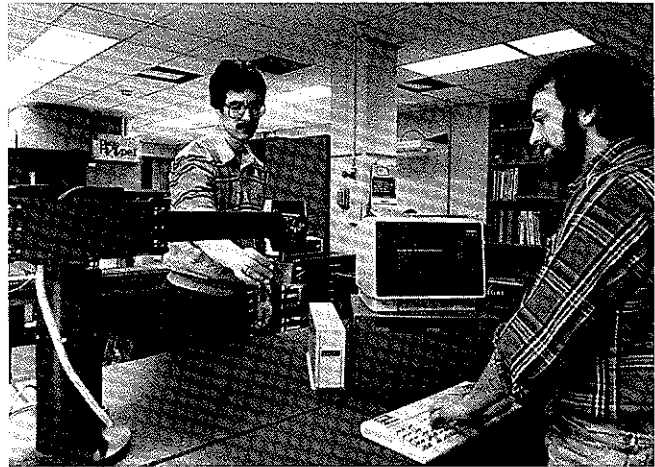

In 1986, prior to the establishment of the Robotics and Automation Laboratory in 1987, Professor Mark Spong (left), shown here with graduate student Rodney Kindler, worked in the Coordinated Science Laboratory. This Motorola MG68000-based computer interface was designed and built to test advanced control concepts for use in high-performance manipulators.

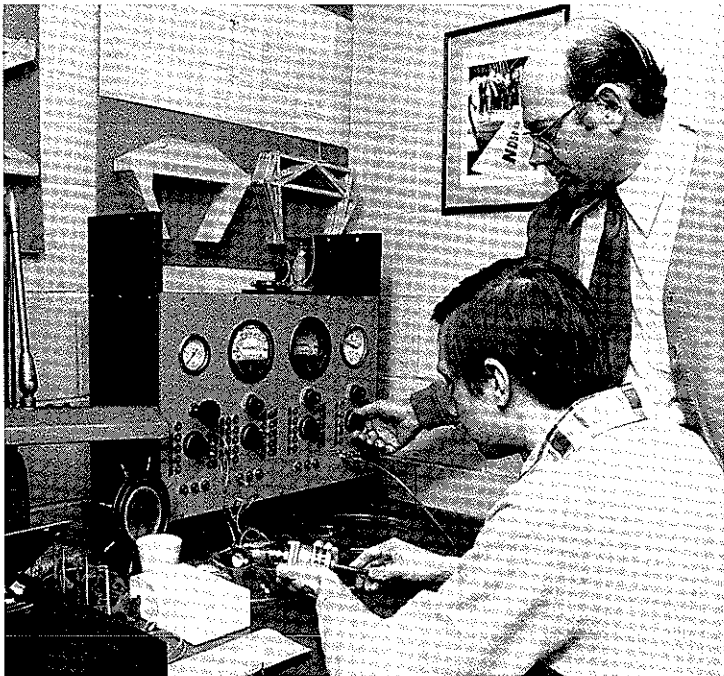

The mid-1970s saw the beginning of robotics research in the department when Professor R. D. Hugelman joined the faculty. In 1978 he and senior Charles Mottier worked on fine tuning a new fluidic drive circuit used with an experimental fluidic pump.

Funding was granted and the General Engineering Robotics Laboratory was established by Spong in January 1987 to support robotics instruction in the department and the newly established College of Engineering Manufacturing Engineering Degree Option Program. Initial financial support for the laboratory was provided by General Motors Corp., Zenith Corp., the Department of General Engineering, the College of Engineering, and the University Research Board.

From 1992 to 1994, the laboratory received a major upgrade with the help of grants from the National Science Foundation Instrumentation and Laboratory Improvement (ILI) Program and the University of Illinois Educational Technologies Board (ETB). Subsequently, the laboratory was merged with the Department of Electrical and Computer Engineering's Robotics Laboratory as part of an effort to establish interdisciplinary, collegewide laboratory facilities. The laboratory is now known as the College of Engineering Robotics and Automation Laboratory to reflect this broader mission.

The Robotics and Automation Laboratory currently houses the following equipment worth over \$400,000:

- Six Rhino educational robots with controllers and teach pendants
- Two Puma 250 robots with controllers and teach pendants
- One RTX SCARA robot

- One CRS Plus robot
- Eight SUN SPARC station Unix workstations
- Ten Dell 486 PC workstations
- A SUN4 Unix workstation
- A MacIIse computer workstation
- Two computer vision systems
- Three specially constructed computer controlled robotic mechanisms for instruction in robotic control systems design
- Two Digital Signal Processor (DSP) development systems
- A General Electric Series Six Programmable Logic Controller (PLC)
- Conveyors, carousels, force sensors, optical sensors

In addition, extensive software is available for 3D-graphics animation of robots and for computer-aided analysis and design of robots and their control systems. Three of the SUN workstations are equipped with CimStation by Silma, Inc., a robotics software package for interactive design, programming, and simulation of automated manufacturing workcells. The software allows students to integrate data from a CAD system into simulation programs, and generate output programs to drive target robots. All workstations are equipped with Mathematica, DADS, Simnon, Matlab, and software for word processing, networking, and programming. All workstations, both in this laboratory and in the College of Engineering workstation laboratories, are equipped with the package Robotica, a Mathematica and X-windows based package for robotic analysis that was developed by Spong and which is currently installed in over 150 robotics laboratories worldwide.

The Robotics and Automation Laboratory is used by a number of classes. These include:

- GE 370/ECE 370, Introduction to Robotics
- GE 389/ECE 371, Robot Dynamics and Control
- GE 489/ECE 489, Advance Control of Robots
- GE 293, Undergraduate Research in Robotics and Automation
- Mfg.E. 210, Introduction to Manufacturing Systems
- GE 491, Simulation of and Analysis of Dynamic Systems
- GE 242, Senior Design Project

The laboratory is used extensively in graduate student research projects and has been a popular exhibit in Engineering Open House, winning many awards. For example, three of the last four Lockmiller Awards have gone to students for projects carried out in the laboratory.

Flexible Automation Coordination Laboratory

The department's Flexible Automation Coordination Laboratory (FACL), developed by Wayne J. Davis (joined the department in 1975), is the second of two research laboratories addressing the decision-making and control issues in computer-integrated manufacturing. The Manufacturing Systems Laboratory (MSL) is a companion laboratory that develops algorithms for the real-time scheduling and control of flexible manufacturing systems for implementation in the FACL.

The FACL has a dual role as a teaching and research laboratory. To fulfill its mission, a unique physical emulator of a flexible manufacturing system (FMS) has been constructed. This physical emulator performs no processing, but rather it has been designed to specifically demonstrate the essential interaction among computerized controllers that are needed to coordinate these systems. Over 14 computers (8 engineering workstations and 6 programmable logic controllers) are included in the emulator. The emulator also includes an HO-scale

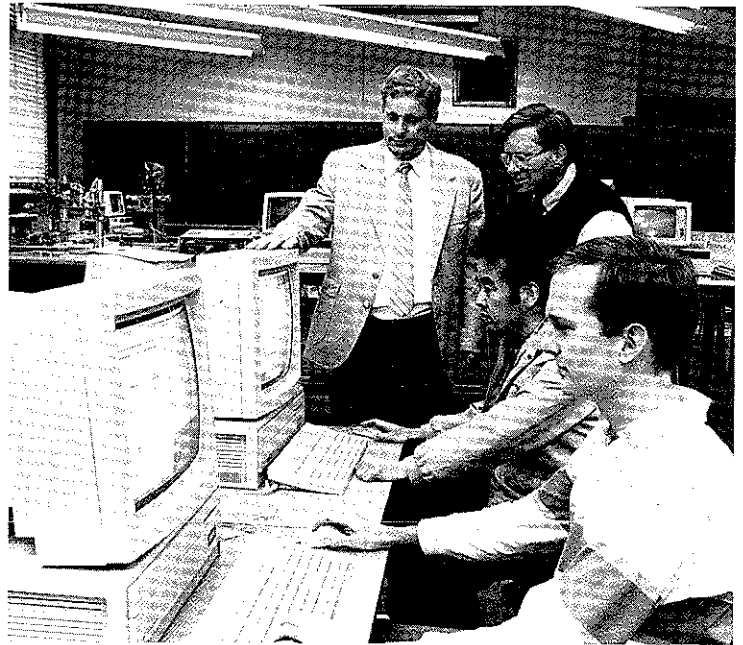

In 1989, Professors S. D. Thompson (standing left) and W. J. Davis (standing right) watch Dr. Hao Wang, visiting scholar from the People's Republic of China, and graduate student Peter Webster as they interact with a real-time simulation of a flexible manufacturing system.

electric train to serve as the primary materials handling system. A physical emulation of an automated storage/retrieval system is being developed to serve as the tool-handling system.

To date, over \$50,000 worth of equipment has been incorporated into the lab, much of which is custom-built. The primary source of funding has been a grant by the General Motors Foundation to the college for laboratory development. A \$3,000 grant also was provided by the campus Educational Technologies Board for purchasing software. Several corporate donations also defrayed the cost of constructing the lab.

In its education role, the emulator teaches engineering students the principles of programming the controllers, with special emphasis on developing the essential interaction among the controllers to coordinate the overall system. The emulator has been especially designed to provide a totally safe environment for the students to master their skills. The education role of the emulator also will supplement existing simulation courses by providing a hands-on facility where students can collect data and verify their models.

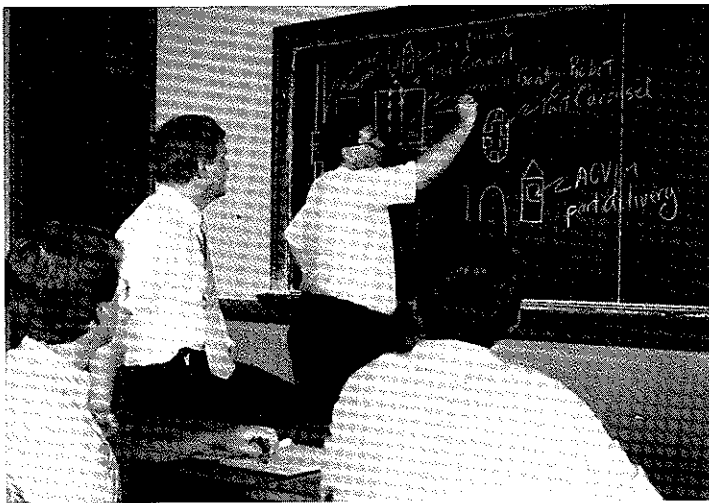

Professor Wayne Davis illustrates a project for colleagues in the Manufacturing Systems Laboratory.

In its research role, the physical emulator provides a facility where long-term testing of scheduling and control algorithms can be addressed. These alpha tests are essential before attempting to implement a developed algorithm on an actual FMS. At this time, plans are being developed to expand the FACL's emulator to include another FMS and a shop-level controller to integrate the operation of the two emulated FMSs. This experimental environment will be essential for testing the algorithms for distributed scheduling that are being developed in the Manufacturing Systems Laboratory.

Manufacturing Systems Laboratory

The department's Manufacturing Systems Laboratory (MSL), under the direction of Wayne J. Davis, is the first of two research laboratories addressing the decision-making and control issues in computer-integrated manufacturing. The Flexible Automation Control Laboratory (FACL) is a companion laboratory for applying algorithms developed in the MSL for the real-time scheduling and control of flexible manufacturing systems.

In MSL, new algorithms for real-time decision making and control are developed to address the distributed production scheduling problem associated with today's flexible manufacturing environments. To support the development of real-time decision-making algorithms, new procedures for real-time discrete-event simulation also are being developed. The latter development has led to the specification of entirely new procedures for modeling and simulating these systems. In addition, the real-time simulation capability has permitted the formulation of new algorithms for searching the decision space to find improved schedules.

MSL addresses the long-term production planning problem and attempts to construct a unified algorithmic approach to the entire computer-integrated manufacturing problem. Eventually the algorithmic development will address strategic planning issues, which include the expansion and reduction of corporate manufacturing resources as well as the introduction and removal of products from the corporate's manufactured product list. Recently, MSL has begun to investigate advanced controllers for the manufacturing processes. These controllers will automatically attempt to improve the manner by which they execute processing tasks.

MSL was initially established with a \$33,000 NSF equipment grant in 1987. During the past eight years, there have been numerous upgrades in the computer equipment made possible via corporate donations and grants, primarily from Motorola, Inc. In fall of 1995, a major upgrade in the computer equipment was initiated to establish a distributed, object-oriented computing environment.



Professor H. L. M. dos Reis and students in the Nondestructive Testing and Evaluation Research Laboratory, 1995.

Nondestructive Testing and Evaluation Research Laboratory

The beginnings of the Nondestructive Testing and Evaluation Research Laboratory can be traced to the senior design course, GE 242, in 1984, when Henrique L. M. dos Reis (joined the department in 1980) was given the task of advising the following project sponsored by Masonite: to investigate a method to evaluate the propensity of fiber hardboard to swell when exposed to moisture. That project won the Merit Award from the Lincoln Arc Welding Foundation. From these humble beginnings, further work on nondestructive testing and evaluation of wire rope and of fiber hardboard was carried out on the fourth floor of the Transportation Building with borrowed equipment from NASA Lewis Research Center. In 1987, an equipment research grant from the National Science Foundation allowed the continuation of research work in acoustic emission and acousto-ultrasonics without the need to borrow equipment.

The Nondestructive Testing and Evaluation (NDT&E) Research Laboratory, under the direction of Reis, houses approximately \$500,000 worth of NDT&E equipment. The original funding was provided by NSF, NASA Lewis Research Center, the department, UIUC, as well as by donations from Sundstrand Aviation, Monsanto Co., Amoco, and Weyerhaeuser Corp.

The laboratory supports research work in the following areas: ultrasonics (immersion, air-coupled, and water-squirt), laser-driven-ultrasonics and interferometry, acoustic emission, acousto-ultrasonics, impact-echo, microfocus radioscopic ultrasonic and x-ray computed tomography, electromagnetics, eddy currents, and holography.

The main research areas are in the development of advanced sensors, on-line process control and materials characterization, life-cycle management of materials and structures, and artificial intelligence toward application in signal analysis and imaging processing. Special emphasis is placed on the development and optimization of those nondestructive evaluation techniques which lend themselves to intelligent manufacturing and construction processes; evaluation/characterization of advanced materials and structures such as polymer and ceramic composites, concrete, and wood and wood composites; noncontact evaluation of materials and structures in unique environments, such as high temperature and radiation; and advanced sensors for industry application. Research is aimed at a systems approach in the field of nondestructive testing and evaluation, focusing on real engineering problems in both real-time process monitoring and control and life cycle management of components which arise from a wide spectrum of applications.

Although traditionally nondestructive techniques have been used almost exclusively for detection of macroscopic defects (mostly cracks) in structural components after they have been in service, it has become increasingly evident that it is both practical and cost effective to expand the role of nondestructive evaluation to include all aspects of materials production and application and to introduce it much earlier in the manufacturing and construction cycle. In this NDT&E Laboratory, efforts are being directed at developing and perfecting techniques which are capable of monitoring and controlling materials production processes, manufacturing and construction processes, and the amount and rate of degradation during the materials in-service life. Using advanced sensors, along with signal/data processing techniques, information on the processing conditions and the properties and characteristics of the materials being processed can be continuously generated. Real-time process monitoring for more effective and efficient real-time process control and improved product quality, safety, and reliability then becomes a practical reality.

Genetic Algorithms Laboratory

The Illinois Genetic Algorithms Laboratory (IlliGAL) was started by David E. Goldberg in fall 1990 when he joined the department. The objective of the lab was and remains the investigation of genetic algorithms (GAs)—search procedures based on the mechanics of natural genetics. Initial funding for the laboratory came from \$75,000 startup funds provided by three sources: the University Research Board, the College of Engineering, and the Department of General Engineering. These funds were used to outfit the laboratory, originally and still housed in 308a Transportation Building, with 4 IBM RS/6000 workstations, printers, and a number of personal computers and peripherals. Donations of equipment and peripherals have expanded the laboratory to a total of 10 workstations in active use. Since the establishment of the lab, additional contracts and grants totaling \$800,000 have been received for basic and applied investigations of genetic algorithms from a variety of sources, including NSF, U.S. Army Strategic Defense Command, U.S. Air Force Office of Scientific Research, NASA, and Deere & Co.

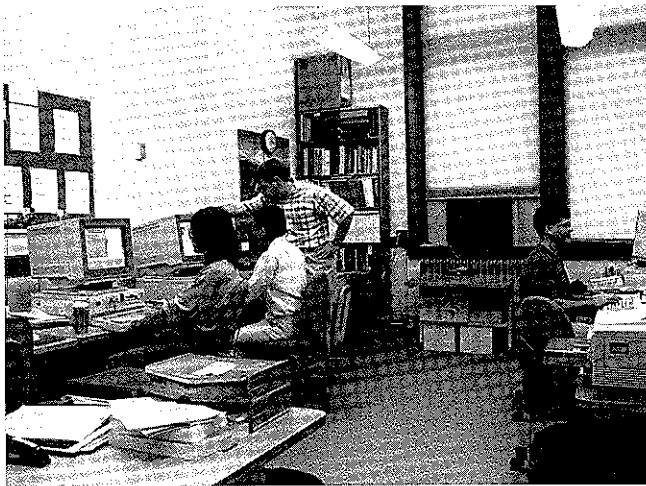

Professor D. E. Goldberg and students Jeffrey Horn, Hillol Kargupta, and Jason Wilcox in the Illinois Genetic Algorithms Laboratory, 1995.

The primary thrust of the laboratory's investigation has been to (1) better understand the operation of genetic algorithms through the development of applicable theory and (2) design GAs that can solve hard problems quickly and reliably. Both of these are difficult problem areas, but the laboratory has been eminently successful by being true to the mission of its home department. The Illinois Genetic Algorithms Laboratory has pioneered an engineering approach to the understanding and design of GAs that has created good GA designs at the same time it has developed good science that helps understand both artificial and natural genetics alike.

Current projects are now considering important facets of GA efficiency, including (1) effective use of computational real estate, (2) effective use of temporal resources, (3) effective subiteration sampling and hybridization, and (4) the possibility of realistic relaxation of convergence criteria and its effect on solution times. Other projects deal with a number of important connections: (1) between GAs and a computational theory of design, (2) between GAs and a computational theory of innovation and creativity, (3) between GAs and a computational theory of organizations, and (4) between GAs and a better understanding of social systems.

Solid Modeling Laboratory

The Solid Modeling Laboratory, under the direction of Yong Se Kim, was established in 1990, the same year Kim joined the faculty, with start-up funds from the department, the college, and the University Research Board. In 1992, additional support was obtained with an NSF Research Initiation Award and by a grant from the University of Illinois NSF Industry/University Cooperative Research Center for Machine-Tool Systems. The industry members include Caterpillar Inc., Ford Motor Co., Ingersoll-Rand, Deere & Co., and Motorola, Inc.

The lab began with 2 Sun SPARCstation 2s, a Macintosh computer, and a printer. It currently houses 3 Silicon Graphics Indigo/Indigo2 workstations and 5

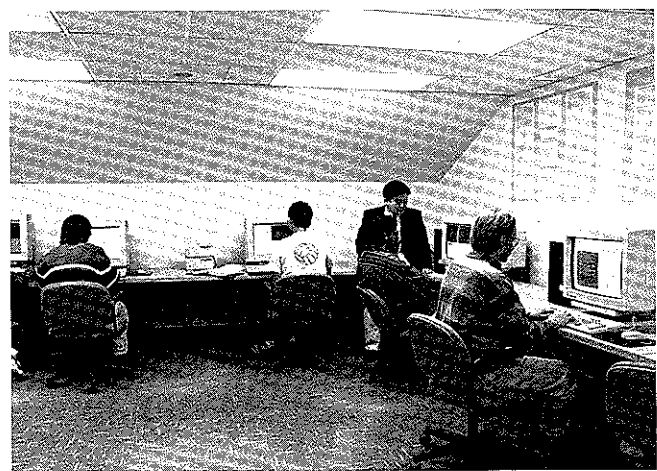

Professor Y. S. Kim and graduate student Sreekumar Monon in the Solid Modeling Laboratory, 1994.

Sun SPARCstations running various software systems, including those developed internally. Since 1991, DESIGNBASE Solid Modeling Toolkit, donated by Ricoh Corp., is used as the primary software system for both research and education. In 1993, 2 Silicon Graphics Indigo workstations were acquired through the NSF Leadership in Laboratory Development grant for visual reasoning instructional software development using university matching funds, and 2 Sun SPARCstation IPXs have been used on loan from the Engineering Graphics and Geometry Lab through the Educational Technology Board project on instructional software development. With the NSF Combined Research-Curriculum Development grant for integrated engineering and industrial design project, one Silicon Graphics Indigo2 workstation has been acquired and used for this interdisciplinary project. For Kim's CAD/CAM education, Intergraph Corp. donated Engineering Modeling Systems (EMS) and full application packages in 1994.

The goals of the Solid Modeling Lab are to provide computer-based aid to improve human visual reasoning and design capability and to enable automated geometric reasoning for computer-integrated design and manufacturing. The Solid Modeling Lab is central to CAD/CAM and engineering graphics and descriptive geometry education at the UIUC. At freshman-level, the GE 103 lab is transitioning toward the Silicon Graphics Indy workstations, which will run the instructional software system being developed in the Solid Modeling Laboratory, as well as commercial software systems for GE 103. Juniors in the manufacturing program are taking the Introduction to Manufacturing Systems course, which is team-taught by faculty in various manufacturing-related areas. For the CAD/CAM portion of this course, Kim is teaching introductory solid modeling using DESIGNBASE. In his new course, Computer-Aided Design Systems, targeted for seniors and graduate students in engineering, hands-on experiences using commercial CAD systems in design and manufacturing engineering applications are provided. DESIGNBASE and Intergraph EMS and application packages are primary software systems used in the course. In the graduate level course, Solid Modeling and CAD/CAM Applications, Kim is teaching the geometrical foundations and algorithms for solid modeling using DESIGNBASE.

Project Design Laboratory

The Project Design Laboratory was established in 1993, and is used as a "commons" area for the industrially sponsored project course required of all general engineering seniors. The room is devoted to student projects and contains 2 high-end PCs networked to a server where software that is acquired for the course is stored. Also, there are 2 Macintosh computers connected to the network of Macintoshes in the CAE Lab. Two

portable computers (one PC and one Mac) have been purchased and are used by the students throughout the semester. In addition, a data acquisition system with a dedicated PC, software and several sampling boards and signal conditioning equipment have been used extensively. A voice mail system has been installed consisting of a dedicated PC and software; each student team has its own mailbox, and all incoming calls are routed to them.

The room houses an extensive library of catalogs from a wide range of suppliers and a register of manufacturers to facilitate student investigation of available technology and the planning of purchases for their projects. There are a variety of hand tools and instruments for student use and space for smaller experiments to be performed. The laboratory provides a meeting room for senior students and helps create a synergy among projects.

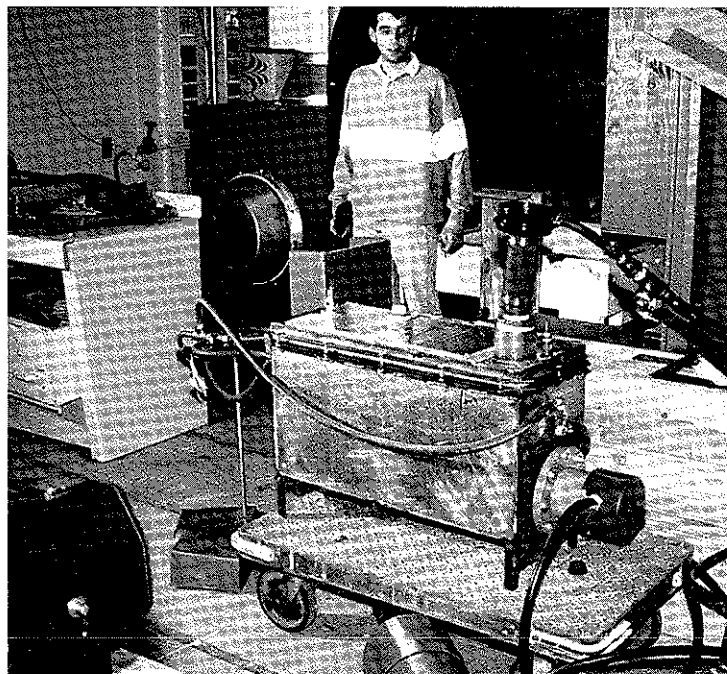

Senior Design Project sponsored by Cummins Engine Co., 1992.

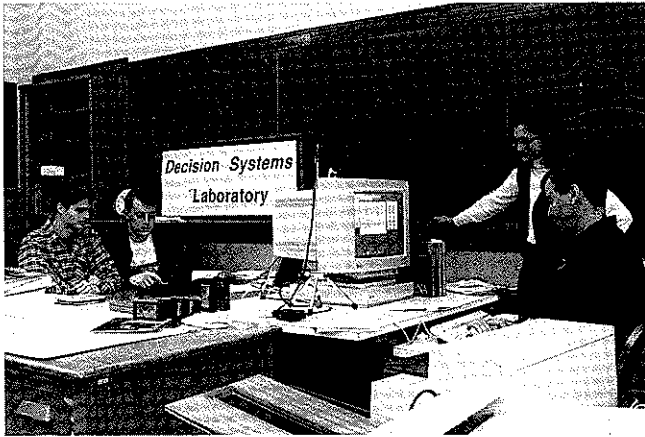

Undergraduates Kelly Carmichael and Brian Binder (at left) integrate the results of their 1995 GE 242 Senior Design Project into research in pollution prevention performed by graduate student Marcus Hatch and Professor Deborah Thurston in the Decision Systems Laboratory.

Decision Systems Laboratory

The Decision Systems Laboratory was established in 1989 as a result of the director, Deborah L. Thurston (joined the department in 1987), being awarded a Presidential Young Investigator Award from the National Science Foundation. The total award was worth \$500,000, consisting of the base grant of \$25,000 annually, plus up to \$37,500 available for each year in NSF matching funds based on industrial funding obtained up to that amount, for a combined NSF/industry total of \$100,000 per year for each of the five years of the program.

The researcher in the laboratory works to develop new computer-based tools for complex design decision making. Several systems have been developed, including a tool for long-range product development planning in the automotive and microelectronics industries, and expert systems which integrate user preferences with expert design knowledge in automotive and structural design. The laboratory supports several different computing platforms to serve the diverse needs of industry: engineering workstations, DOS-based systems, and Macintosh systems. Graduate student researchers include students pursuing an MS in general engineering as well as PhD students from the departments of Civil Engineering and Mechanical and Industrial Engineering.

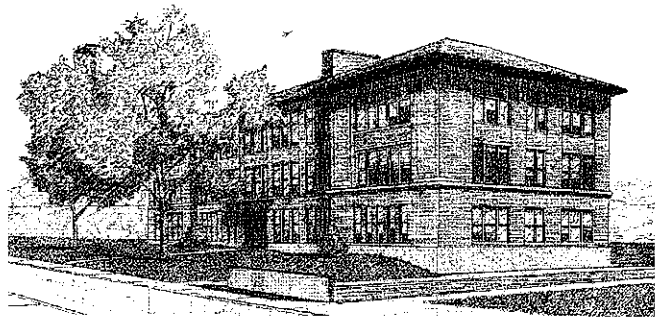

Chapter 5

Grants and Research Funding

One of the greatest challenges facing the Department of General Engineering in 1959 was obtaining sponsored research and grants for educational development. Early in his tenure as department head, Jerry S. Dobrovolny went to Washington, DC, to visit various funding agencies such as the National Science Foundation (NSF), the U.S. Army Corps of Engineers, the Department of Education, as well as the congressional and senate offices of the Illinois delegation.

The problem of visibility was critical. Lacking staff with PhDs and established areas of research, the chance of obtaining funding was remote. Upon his return from Washington, DC, Dobrovolny began to familiarize himself with all of the programs being advertised by various funding agencies to determine where the department might submit proposals.

The first of these was a proposal to NSF for a six-week Summer Science Training Program for high-ability secondary school students interested in science and engineering. This was first funded in 1959–60 and was funded for 17 years. As a result, Dobrovolny was invited to attend director's meetings as well as being on NSF panels evaluating proposals. This enabled him to become aware of other areas of opportunity.

Another person that was involved in obtaining research support was John E. Pearson. He had been working with the Illinois Water Survey and became aware of some funding opportunities in the area of radon gas measurement. His first proposal was funded in 1960–61 by a joint fund from the U.S. Department of Health, Education and Welfare (HEW) and the Public Environmental Service (PES).

A table listing the various awards from 1959 through 1995 is on page 66. In order to be successful in obtaining research grants, the department needed to have faculty with doctoral degrees and an established graduate

program. Therefore, it was not until 1977 when the MS degree had been approved that there was a significant increase in funded research in the hard science areas in the department.

To adequately identify the various grants that have been obtained, the following listings have been separated into several categories: curriculum development and training grants, technology teacher education grants, pre-college student programs, and the listing of individual faculty research grants.

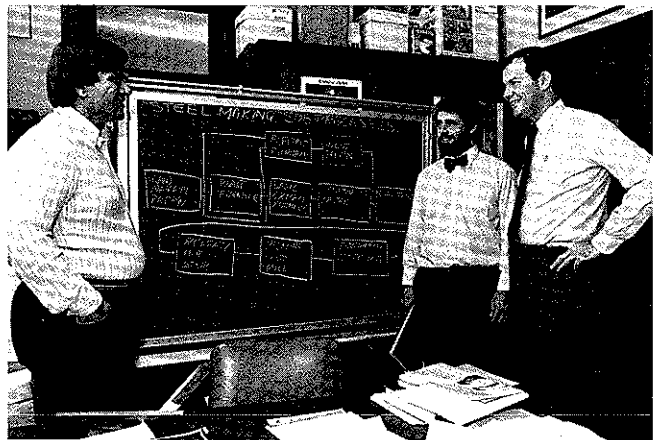

In 1984, professors Wayne J. Davis, James V. Carnahan, and Thomas F. Conry studied models and strategies for eliminating scheduling and control problems in the steel industry.

Curriculum Development and Training Grants

Some of the early grants resulted from the work being done by Dobrovolny in the area of technical education developing one- and two-year programs to train technicians. Later, other grants dealt with the curriculum in general engineering involving other faculty.

Engineering Technology Grants

USOE	U.S. Office of Education Civil Engr. Technology Curriculum Guide (J. S. Dobrovolny)	1962-63	\$14,250
USOE	Highway Engineering Aide Curriculum Guide (J. S. Dobrovolny)	1962-63	\$5,600
IBVE	Illinois Board of Vocational Education Curriculum Development in Engineering Technology (J. S. Dobrovolny)	1962-63	\$15,900
		1963-64	19,080
		1964-65	19,510
		1965-66	35,140
		1966-67	36,151
IBVE	Vermilion County Technician Need Study (J. S. Dobrovolny)	1962-63	12,688
		1963-64	10,000
IBVE	Lake County Technician Need Study (J. S. Dobrovolny)	1963-64	12,730
		1964-65	24,663
		1965-66	2,000
USOE	Micro Precision Technology Curriculum Development and Demonstration (J. S. Dobrovolny)	1966-67	\$116,467
		1967-68	50,158
NSF	Electronics Technology Curriculum Development (J. S. Dobrovolny with D. S. Babb, Electrical Engineering)	1968-69	\$183,170
	Total		\$526,757

General Engineering Curriculum Grants

Ford	Ford Foundation Project Design Grant Foundation (J. S. Dobrovolny, project director; B. O. Larson, associate project director)	1966-67	\$ 7,413
		1967-68	11,365
		1968-69	10,700
		1969-70	12,272
		1970-71	68,350
		1971-72	38,086
		1972-73	13,980
	Total		\$ 162,166
NSF	Case Studies in Engineering Design (R. J. Placek, director)	1966-67	\$ 15,963
Project EXCEL	Computer Graphics Grants (M. H. Pleck and T. R. Woodley, project directors)		
	IBM Equipment Grants	1984-85	\$335,370
		1985-86	57,475
	Campus	1984-85	44,900
		1985-86	60,825
		1986-87	49,000
	College of Engineering	1984-85	21,000
		1985-86	17,500
		1986-87	25,000
	Illinois Society of Professional Engineers	1984-85	16,000
	Equipment Grant	1985-86	68,500
	Department of General Engineering	1984-85	69,700
		1985-86	60,000
		1986-87	48,250
	Total		\$873,520

Technology Teacher Education Grants

In the 1960s and 1970s, there was a strong movement throughout the United States to develop educational programs for the preparation of engineering technicians. One of the needs was to provide teachers for this activity. Dobrovolny was one of the leaders in organizing Summer Institutes and Academic Year Institutes for teachers moving into the engineering technology programs.

NSF	Summer Institutes for Electronics Technology and Machine Design Technology (J. S. Dobrovolny, project director)	1966-67	\$ 7,413
		1967-68	11,365
		1968-69	10,700
		1969-70	12,272
		1970-71	68,350
		1971-72	38,086
		1972-73	13,980
	Total		\$ 162,166

NSF	Academic Year Institutes	1963-64	\$ 99,100
	for Electronics	1964-65	116,400
	Technology and	1965-66	116,400
	Machine Design	1966-67	129,140
	Technology Teachers	1967-68	134,820
	(J. S. Dobrovolny, project director)	Total	\$595,760
USOE	Summer Institute for	1964-65	\$44,736
	High School Drafting Teachers		
	(J. S. Dobrovolny, project director)		
IBVE	Technology Teacher	1967-68	\$ 7,930
	Preparation	1968-69	9,640
	(J. S. Dobrovolny, project director)		
	Total		\$62,306

Pre-College Student Science Program

One of the first grants to the Department of General Engineering was under the NSF Summer Science Training Program (SSTP) for high-ability secondary students. J. S. Dobrovolny was the director and B. O. Larson and D. C. O'Bryant were associate directors.

NSF	SSTP High School Student	1959-60	\$13,700
		1960-61	11,335
		1961-62	13,909
		1962-63	12,570
		1963-64	13,950
		1964-65	14,270
		1965-66	14,785
		1966-67	15,325
		1967-68	13,850
		1968-69	14,403
		1969-70	14,921
		1970-71	15,726
		1971-72	21,204
		1972-73	21,904
1975-76	23,020		
	Total		\$234,872

Technology Audit and Assessment Programs

In 1983, the department became involved with the University of Illinois Advanced Manufacturing Center located in Rockford, Illinois. Ronald L. Ruhl at the time was an adjunct professor offering short courses for practicing engineers in industry to make manufacturing operations more efficient. In 1986, this led to the development of the Technology Audit and Assessment Program, responding to the needs of small and medium sized companies that do not have adequate resources to sustain an on-going research effort necessary to maintain competitive positions in the marketplace.

Ruhl headed up the program working with Rodney D. Hugelma and research engineer Harry S. Wildblood. In 1987, the College of Engineering assigned \$20,000 from the Office of Advanced Engineering Studies as matching seed money to client fees. The support for the program is listed below.

College of Engineering	1986-87	\$20,000
Warner Lumbers	1986-87	5,000
	1987-88	3,500
Hydroline	1986-87	5,000
	1987-88	26,106
	1988-89	45,011
	1989-90	1,784
Micro Switch	1988-89	26,928
	1989-90	14,405
Century Tool	1988-89	3,345
	1989-90	15,179
	1990-91	9,334
Illinois Concrete Amerock	1989-90	20,917
	1989-90	21,658
	1990-91	7,000
	1991-92	20,849
	1992-93	4,000
Ballco	1989-90	6,000
	1990-91	6,612
Recor	1990-91	23,232
	1991-92	13,080
	1990-91	22,708
Swift Electric	1990-91	22,708
Alvmax	1990-91	6,667
	1991-92	14,872
Counselor	1991-92	707
General Cable	1991-92	2,000
Hawking	1991-92	5,767
	1992-93	6,169
Hussman	1991-92	25,474
Advanced Lifts	1991-92	14,000
	1992-93	471
APL	1992-93	6,000
Total		\$403,775

Individual Faculty Research Grants

William E. Berkow

W. E. Berkow's research interests were in modern machine shop practices, particularly in the area of gage block measurements and standardizations. His research studies were funded from industry.

Kearney & Trecker	1960-61	\$ 1,500
	1967-68	13,312
	1968-69	27,042
	1969-70	20,000
	1970-71	18,846
Total		\$80,700

Scott A. Burns

S. A. Burns' research interest falls into three broad areas: structural optimization, numerical methods, and scientific visualization. A significant amount of his support has come from being awarded an NSF Presidential Young Investigator Award (NSF-PYI).

UI Research Board	1985-86	\$ 3,900
NSF equipment grant	1986-87	94,000
Southern Illinois University Tech Center		7,000
National Wheelchair - A.A.		20,000
Apple Computer, Inc., equipment	1987-88	5,796
Computer-aided Engineering (CAE) Lab - campus		80,000
NSF Engr. Initiative	1988-89	35,570
UI Research Board		5,590
Apple Computer, Inc., equipment		87,581
NSF Engr. Initiative	1989-90	25,694
NSF PYI (Presidential Young Investigator)		25,000
International Paper	1990-91	933
NSF PYI		61,236
NSF REU (Research Experiences for Undergraduates)		15,000
Absoft Corp., equipment, PYI match		3,692
Apple Computer, equipment, PYI match		6,355
Digital Equipment Corp.		45,817
Motorola, Inc., equipment		22,250
NOVY Systems, equipment, PYI match		4,434

NSF PYI	1991-92	62,500
NSF REU		15,000
NSF PYI	1992-93	62,500
Shell Oil Co., equipment		90,000
NSF REU		10,000
Apple Computer, Inc., equipment		36,481
NSF PYI	1993-94	62,500
NSF REU		16,800
NSF PYI	1994-95	37,500
CAE Lab, upgrade		66,000
Total		\$1,009,129

James V. Carnahan

J. V. Carnahan's research interests are in the area of application of statistical analysis to engineering problems, including the interaction of operations research methodology in aspects of transportation engineering. Appointed director of the senior project design course in August 1992, he supervises all of the undergraduate design projects.

U.S. Army Construction Engr. Research Laboratory (CERL)	1988-89	\$27,452
UI Research Board	1989-90	10,678
Various companies (GE 242)	1992-93	206,250
	1993-94	214,500
	1994-95	232,000
Total		\$484,630

Thomas F. Conry

T. F. Conry's research interests are in turbo-rotor vibrations, tribology, and failure of rolling element bearings. The work impacts on gear design for surface durability and design of surfaces for elastic bodies in contact. In recent years, his work has focused on the thermomechanical analysis of railroad bearing/axle systems to develop an understanding of the mechanism of railroad bearing burnoff.

National Aeronautics & Space Administration (NASA)	1976-77	\$22,510
NSF	1982-83	24,892
	1983-84	25,017
	1985-86	19,980
Assn. of Am. Railroads (with C. Cusano)	1987-88	10,000
	1988-89	64,729
	1989-90	64,781
	1990-91	74,205
S&C Electric	1990-91	16,000
Assn. of Am. Railroads (with C. Cusano)	1991-92	60,000
	1992-93	60,000
	1993-94	77,738
Total		\$519,852

Osman Coskunoglu

O. Coskunoglu's research interests are in the area of operations research as applied to various decision models in management and the solution of engineering problems. He also is doing research on design and operation of a manufacturing system for mixed model and just-in-time production.

U.S. Army CERL	1984-85	\$14,568
	1985-86	91,126
	1986-87	113,677
	1988-89	27,410
	1990-91	10,000
U.S. Army Intergovernmental Personnel Act (IPA)	1990-91	10,000
	Total	\$266,781

Wayne J. Davis

W. J. Davis' research interests have focused on the development of advanced manufacturing systems to develop solutions for the computer-integrated manufacturing problem.

NSF ENG	1977-78	\$14,891
	1978-79	16,301
U.S. Department of Energy (Purdue)	1982-83	10,273
	1983-84	21,468
UI Research Board	1985-86	6,220
	1987-88	6,000
NSF, equipment grant	1987-88	30,000
	1988-89	3,393
Dept. of General Engr.	1988-89	10,000
	1989-90	5,000
National Institute of Standards and Technology (NIST) matching	1989-90	13,155
NIST	1989-90	25,000
	1990-91	15,000
Manufacturing Research Center (MRC)-Caterpillar, Inc.	1989-90	21,250
	1990-91	21,250
MRC-Motorola, Inc.	1989-90	20,000
	1990-91	23,500
	1991-91	26,500
	1992-93	12,000
	1993-94	20,000
	1994-95	21,250
Motorola fellowship	1989-90	15,545
	1990-91	16,633
	1991-92	17,000
Naval Air Warfare Center (NAWC)	1994-95	24,854
Total		\$416,483

Jerry S. Dobrovlny

J. S. Dobrovlny's research interests were in curriculum development for two-year Associate Degree Programs in Engineering Technology as well as in project design in general engineering. He also was involved with the preparation of teachers for engineering technology programs and precollege student science programs. His grants are listed previously in this section. The total is \$2,281,249.

David E. Goldberg

D. E. Goldberg's research interests are in genetic algorithms-search procedures based on the mechanics of natural selection and natural genetics.

U.S. Army Strategic Command	1990-91	\$96,824
	1991-92	190,541
Dept. of General Engr. and College of Engr. match	1990-91	50,000
NSF ECS (Electric & Communications Systems)	1990-91	150,000
NSF PYI	1990-91	8,400
UI Research Board	1990-91	25,000
U.S. Army	1992-93	92,656
	1992-93	27,000
	1993-94	27,000
NASA fellowship	1994-95	27,000
U.S. Air Force	1993-94	46,001
	1994-95	167,402
NSF INT	1994-95	4,716
Total		\$912,540

W. Brent Hall

W. B. Hall's research interests include reliability methods in structural design, reliability models of load testers, structural standardization and optimization, structural mechanics, and cold formed steel design.

NSF	1987-88	\$72,530
	1988-89	67,637
Total		\$140,167

Rodney D. Hugelma

R. D. Hugelma's research interests were in applied fluids in the design environment. His work with the senior project design course was supported by a large number of companies.

U.S. Army CERL	1989-90	\$10,000
----------------	---------	----------

Yong Se Kim

Y. S. Kim's research interest is in the area of computer-aided design and manufacturing, solid modeling, and geometric and visual reasoning.

UI Research Board, College of Engr., GE Dept.	1989-90	\$69,000
	1990-91	2,599
	1992-93	7,872
	1993-94	8,000
(Educational Technologies Board /GE Dept./Col./Res. Board; NSF cost sharing)	1993-94	65,943
	1994-95	2,250
NSF DDM (with Pleck and Woodley)	1992-93	59,966
	1993-94	30,000
NSF DUE	1992-93	75,328
NSF EEC (with Philpott and Arends)	1994-95	277,840
Vice Chancellor Teaching Scholar	1994-95	3,400
Vice Chancellor Course Development	1994-95	6,000
Manufacturing Research Center (MRC) (with C. Hayes)	1994-95	6,000
Total		\$621,258

Edward N. Kuznetsov

E. N. Kuznetsov's research interests cover a spectrum of problems in structural analysis, including finite-element method for the analysis of arbitrary shells of revolution under axisymmetric load and temperative and tensile structural problems of design optimization.

Naval Air, grant	1981-82	\$24,430
NSF CEE	1982-83	4,817
	1983-94	16,672
U.S. Army CERL IPA	1984-85	68,981
	1985-86	49,804
	1986-87	27,467
California Institute of Technology / NASA	1985-86	27,374
U.S. Army CERL	1985-86	10,840
	1986-87	23,109
Satellite Communication Agency	1987-88	131,360
	1988-89	47,633
Total		\$442,187

Juraj V. Medanic

J. V. Medanic's research interests lie in the area of large-scale systems design using various optimization techniques.

DOE LLL	1985-86	\$85,000
Joint Services Electronics Program, (through the Coordinated Science Laboratory, CSL)	1987-88	60,000
	1988-89	60,000
	1989-90	95,000
	1990-91	95,000
Sundstrand Corp.	1987-88	45,359
	1988-89	25,000
	1989-90	22,000
	1990-91	30,000
Wright-Patterson Air Force Base (through CSL)	1987-88	32,000
	1988-89	32,000
	1989-90	32,000
Caterpillar, Inc.	1992-93	22,195
Total		\$635,554

L. Daniel Metz

L. D. Metz's research interests are in the area of vehicle dynamics and safety. Much of his work is with clients in the field investigating accidents.

UI Research Board	1980-81	\$1,500
CROP Research	1990-91	1,000
Total		\$2,500

Manssour H. Moeinzadeh

M. H. Moeinzadeh's research interests are in the bioengineering area dealing with the modeling of human joint structures and rehabilitation engineering.

General Motors Corp.-Guide Division	1983-84	\$3,500
UI Bio Engr. Research Board	1983-84	1,500
	1984-85	7,414
	1985-86	9,027
	1986-87	6,260
	1987-88	8,000
	1988-89	4,500
	1989-90	1,279
	1992-93	8,566
	1993-94	5,593
	1994-95	6,025
Whitaker Foundation	1985-86	43,526
	1986-87	44,485
Bio Engr. equipment	1986-87	2,250
Dept. of Mech. & Indus. Engr. grant	1986-87	6,190
National Wheelchair Assn. (through UIUC Division of Rehabilitation)	1986-87	7,473
	1987-88	7,473
Ralston Purina (through College of Veterinary Medicine)	1986-87	29,929
	1987-88	32,583
	1988-89	21,915
Rehabilitation Education Center	1986-87	2,362
Veterans Administration (through UIUC Division of Rehabilitation)	1988-89	21,625
	1989-90	21,625
Dept. of General Engr.	1987-88	4,500
Nordic Track (with Univ. of Nevada)	1994-95	13,000
Total		\$320,600

John E. Pearson

John E. Pearson's research interests were in the area of atmospheric science and meteorology. He was a pioneer in measuring radioactive hazards in the atmosphere, particularly radon gas.

U.S. Department of Health Education, and Welfare-PES	1960-61	\$8,495
	1961-62	33,385
	1962-63	28,949
	1963-64	26,235
Total		\$97,064

Michael H. Pleck with Thomas R. Woodley

The research interests of Pleck and Woodley are in geometrical modeling systems and the networking of microcomputers in the teaching engineering graphics and computer-aided design. They were responsible for obtaining the Project EXCEL grant from IBM Corp.

IBM EXCEL grant	1984-85	\$335,370
	1985-86	93,025
	1986-87	22,290
Campus-EXCEL	1984-85	44,900
	1985-86	60,825
	1986-87	49,000
College of Engineering-EXCEL	1984-85	12,000
	1985-86	17,500
	1986-87	25,000
State Matching Equipment-EXCEL	1984-85	16,000
	1985-86	68,500
Dept. of General Engr.-EXCEL	1984-85	69,700
	1985-86	60,000
	1986-87	48,250
Zenith Corp., equipment	1986-87	71,461
College of Engineering remodeling and equipment	1986-87	85,000
NSF computer short course	1988-89	62,266
Campus computer usage (GE 103 CAE Lab)	1987-88	40,000
	1988-89	38,865
	1989-90	38,865
	1990-91	38,634
	1991-92	27,000
	1992-93	58,250
	1993-94	58,250
	1994-95	20,625
Total		\$1,470,576

Jahangir C. Rastegar

J. C. Rastegar's research interests were in the area of structural dynamics of the human leg studying the stiffness characteristics of the ankle joint, hip joint, and spinal column.

NSF	1979-80	\$ 9,929
	1980-81	22,071
Total		\$32,000

Henrique L. M. dos Reis

H. L. M. dos Reis's research interests are in the field of nondestructive testing of materials and structures, quality control inspection methods in manufacturing, mechanics of composite materials and design of composite structures and dynamic elastic-plastic behavior of anisotropic structural elements.

Monsanto Co.	1987-88	\$35,000
NASA Lewis Research Center	1987-88	21,205
NASA	1994-95	5,000
Dept. of General Engr.	1988-89	17,000
NSF, equipment	1988-89	45,200
UI Research Board	1988-89	8,000
Weyerhaeuser	1988-89	13,500
U.S. Army CERL	1988-89	10,000
Goodyear Tire & Rubber Co.	1989-90	68,210
General Electric Co.	1990-91	45,360
American Retreader's Assn.	1994-95	6,000
Amoco	1994-95	10,000
U.S. Army	1994-95	67,461
Illinois Dept. of Natural Resources	1994-95	114,568
Total		\$466,504

Roland L. Ruhl

R. L. Ruhl's research interests are in the area of software support for microcomputer intelligent measurement and control; simulation of dynamic systems; and vehicle dynamics, particularly as they relate to accident reconstruction. He also developed the Technical Audit and Assessment Program in the Department of General Engineering discussed earlier in this chapter. Other grants he has received are below.

National Clearing House for	1971-72	\$ 7,080
Correctional Programming	1972-73	7,080
Cummins Engine	1993-94	25,736
Total		\$39,896

Mark W. Spong

M. W. Spong's areas of research are in control systems and robotics particularly in adaptive control of robot manipulators.

Dept. of General Engr.	1984-85	\$ 6,500
NSF	1985-86	61,632
	1986-87	62,632
	1988-89	4,000
	1991-92	127,511
Dept. of General Engr., matching	1985-86	8,752
	1986-87	9,368
Dept. of General Engr./College of Engr./CSL	1987-88	30,000
UI Research Board	1985-86	8,399
	1987-88	10,000
	1989-90	10,000
U.S. Army CERL	1987-88	100,000
	1988-89	10,000
	1989-90	15,000
MRC	1990-91	40,000
Total		\$503,794

Ramavarapu S. Sreenivas

R. S. Sreenivas' research is in discrete event dynamic systems, an emerging area of research that models man-made systems.

UI Research Board	1992-93	\$20,113
Total		\$20,113

Mark G. Strauss

M. G. Strauss' research interests are in the bioengineering area, developing aides such as wheelchairs for persons with disabilities.

Autodesk Award	1987-88	\$8,710
Bioengineering Committee	1988-89	4,280
UI Research Board	1988-89	6,314
NSF	1988-89	109,090
Tektronix and matching	1987-88	27,315
Veterans Administration	1988-89	43,250
Total		\$198,959

S. Daniel Thompson

S. D. Thompson's research interests were in applying optimization techniques in materials handling problems and manufacturing engineering.

College of Engineering	1987-88	\$1,699
Dept. of General Engr.	1987-88	1,699
Engineering Foundation	1988-89	20,000
UI Research Board	1987-88	3,398
	1989-90	2,055
Total		\$28,851

Deborah L. Thurston

D. L. Thurston's research activities are in the area of engineering design theory and methodology as they relate to the design-evaluate-redesign cycle of the concurrent engineering process. She has developed a theory of normative decision analysis to remedy problems in the manufacturing sector.

Chrysler Corp.	1988-89	\$65,577
	1989-90	27,772
	1990-91	5,109
Electric Power Research Institute (EPRI)	1992-93	10,000
	1992-93	10,000
Ford Motor Co.	1993-94	7,500
	1992-93	31,477
General Motors CSS-49913	1993-94	1,800
	1994-95	25,000
Illinois Department of Natural Resources	1988-89	35,570
	1989-90	25,694
NSF DDM - PYI	1989-90	25,000
	1990-91	62,000
	1991-92	62,500
	1992-93	62,500
	1993-94	62,500
	1994-95	37,500
NSF REU	1991-92	10,000
	1994-95	10,000
U.S. Army	1987-88	4,294
	1988-89	570
	Total	\$582,363

Louis Wozniak

L. Wozniak's research interests are in the area of digital control theory with applications to control of dynamic mechanical systems. The specific application has been to optimal speed control of hydropower-generating systems.

Woodward Governor	1967-68	\$3,100
	1968-69	3,400
	1969-70	3,800
	1970-71	4,100
	1971-72	4,100
	1972-73	4,950
	1973-74	5,400
	1975-76	6,300
	1976-77	6,525
	1977-78	6,900
	1978-79	7,275
	1988-89	5,000

U.S. Bureau of Reclamation	1985-86	144,627
	1986-87	65,411
U.S. Department of the Interior	1987-88	44,662
	1990-91	8,000
International Paper Co.	1991-92	1,000
	Total	\$324,550

Miscellaneous Grants

Down through the years, the Department of General Engineering received various equipment and money grants. These are listed below.

Ford Foundation	1966-67	\$7,413
	1967-68	11,365
	1968-69	10,700
	1969-70	12,272
	1970-71	68,350
	1971-72	38,068
1972-73	13,980	
	1986-87	71,719
General Motors Foundation	1984-85	21,000
IPA	1986-87	20,000
Keysor-Warner	1990-91	70,000
State of Illinois equipment (ISPE)	1992-93	100,000
	1993-94	89,000
	1994-95	126,000
	1990-91	19,228
CAE equipment	1991-92	8,000
	1992-93	62,876
	1993-94	84,680
	1994-95	61,678
	Total	\$896,329

Summary

Listed below is a summary of all the grants plus the funds raised through the Project Design program.

Year	Grants	Project Design
1959-60	13,700	
1960-61	59,430	
1961-62	99,894	
1962-63	181,717	
1963-64	239,095	
1964-65	277,709	
1965-66	233,648	
1966-67	383,149	7,413*
1967-68	330,025	11,365*
1968-69	318,056	10,700*
1969-70	107,907	12,272*
1970-71	164,482	68,350*
1971-72	70,470	38,086*
1972-73	56,884	30,030 (13,980*)
1973-74	46,420	18,820
1974-75	30,459	7,659
1975-76	41,630	12,310
1976-77	46,085	17,050
1977-78	48,041	26,250
1978-79	35,328	11,750
1979-80	56,619	44,000
1980-81	99,571	76,000
1981-82	140,580	116,150
1982-83	141,482	161,500
1983-84	178,157	113,500
1984-85	702,983	97,550
1985-86	970,300	85,500
1986-87	813,631	94,140
1987-88	878,787	115,500
1988-89	1,272,987	127,500
1989-90	833,603	144,000
1990-91	1,218,468	126,000
1991-92	947,552	239,000
1992-93	945,442	206,250
1993-94	822,898	214,500
1994-95	1,296,449	232,000
Total	\$14,103,638	\$2,465,145

*Funds from the Ford Foundation

Chapter 6

Student and Alumni Activities

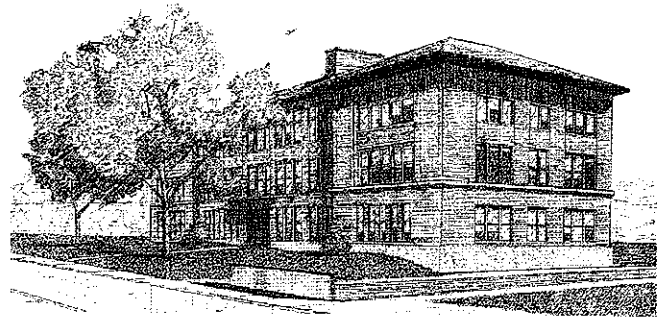

A membership certificate indicates that Phi Alpha Lambda was founded on April 7, 1925, as an honorary general engineering fraternity. In searching the university records, the author was unable to find any mention of how long the fraternity was active. A letter dated May 8, 1991, from Joseph L. Pertel, a 1926 general engineering graduate, enclosed a copy of a program of an initiation banquet of Phi Alpha Lambda held on December 15, 1925. It appears as though the fraternity was an organization recognizing honor students in the entire College of Engineering.

Early in the 1950s, the Illinois Society of General Engineers (ISGE) was organized. The chapter meets several times a semester and brings speakers from industry. It sponsors such social functions as bowling tournaments with the faculty, picnics, softball games, etc. Its representatives have been active in the College of Engineering Student Council.

The students have been active in participating in the college's Engineering Open House held during the spring semester. Many of its projects have received awards in competition with all the other departments. At the annual St. Pat's Ball many have been knighted as a Knight of St. Pat.



Professor Robert A. Jewett addresses a meeting of the Illinois Society of General Engineers.

The general engineering honor society, Gamma Epsilon, was organized in the spring of 1962 after several students in ISGE suggested there was a need for one. Jerry S. Dobrovolny, department head, assigned the responsibility for the establishment of the honor society to Harrison Streeter (joined the department in 1956), who became the faculty adviser and remained as such until his retirement in 1990, except for 1964–66 when he was on leave to study for his PhD at the University of Iowa. (David C. O'Bryant took over during his absence.)

The charter members were: Bennie D. Babb, Jerry A. Bilek, Charles F. Headbloom, Jr. (pres.), James M. Henson (sec. treas.), Sam L. Leeper, Richard H. Miller, Jr., John Nonneman, John D. Raffl, and Edward C. Wahl.

The eligibility requirements were:

- First semester junior
 - 4.5 minimum grade-point average (GPA)*
- Second semester junior
 - upper 1/8 of class, 4.2 minimum GPA
- First semester senior
 - upper 1/5 of class, 4.0 minimum GPA
- Second semester senior
 - upper 1/4 of class, 4.0 minimum GPA

*Grade-point average based on 5.0 scale.

In addition, seniors with outstanding activity records whose GPA fell below the slated minimum grade-point average could be considered for membership. In the early 1970s, the eligibility requirements were revised to bring them in line with other honor societies in the college. The new requirements admitted a student with 45 semester hours and a 4.25 GPA. In the spring of 1963, Constance Mayer was the first woman member to be initiated. Since then, women have played an increasing role in the society, both in terms of membership and leadership.

In the early days, new initiates were provided with a rough cast brass medallion that they were required to smooth and polish to a high luster. Later, inscribed paper weights were purchased from a vendor to replace the medallions. In the fall of 1986, Gamma Epsilon initiated its 500th member.

At the suggestion of Gamma Epsilon member Leonard Duchnowski, the General Engineering Distinguished Alumni Award was established in 1974. Each awardee was made an honorary member of Gamma Epsilon. Honorary faculty members include Jerry S. Dobrovolny, 1970, Howard W. Knoebel, 1979, and Harrison Streeter, 1983.

Distinguished General Engineering Alumni Award Winners

1974

Kenneth W. Hamming, '40
Senior Partner, Sargent & Lundy Engineers, Chicago, Ill.

Barbara C. Johnson, '46
Manager, Mission System Requirements,
Space Shuttle Program
Rockwell International, San Pedro, Calif.

Harry E. Hawkins, '52
President, Rockford Controls; President, Reed Devices,
Inc., President, Spindex Inc.
Rockford, Ill.

1975

Roy S. Carver, '34
President, Carver Industries, Muscatine, Iowa

In 1974, the nation's top-ranking woman space engineer, Barbara Crawford Johnson, was honored by the department as an outstanding alumna. She was manager of systems requirements for the space shuttle program in Rockwell International's Space Division. In 1946, she had been the first woman graduate of the department.



1976

George S. Trees, '37
Vice President, Chicago Bridge & Iron, Chicago, Ill.

Arthur G. Dixon, '24
President, Modine Manufacturing, Racine, Wis.

1977

Robert W. Rasmus, '48
President, Masonite Corp., Chicago, Ill.

1978

William A. Chittenden, '50
Senior Partner, Sargent & Lundy Engineers, Chicago, Ill.

1979

Richard L. Hoard, '59
Vice President, Ecodyne Corp., Chicago, Ill.

1980

Kenneth A. Gablin, '56
Consultant, Nuclear Disposal, McLean, Va.

1981

Gary L. Newton, '57
Chief Patent Counsel, Chrysler Group, Detroit, Mich.

1982

Bruce R. Holecek, '71
President & Owner, Tower Hobbies, Champaign, Ill.

1983

John R. Green, Jr., '60
President, Admiral Division of Magic Chef, Inc.,
Schaumburg, Ill.

1984

Lester A. Boldebuck, '50
Senior Vice President, Northern Illinois Gas, Naperville,
Ill.

1985

Christ D. Kacalief, '44
President, Chris Kaye Plastics Corp., St. Louis, Mo.

1986

Walter W. Foster, '55
Vice President of Corporate Growth and Planning for
General Mills, Wauzata, Minn.

1987

Richard D. Jonson, '56
President, United Technologies Electro System, Inc.,
Columbia, Miss.

1988

Jerry S. Dobrovolny, '43
Former Professor and Head, Department of General
Engineering, Urbana, Ill.

1989

Richard W. Reynolds, '53
Chief Research Engineer, Sundstrand Advanced Technol-
ogy Group, Rockford, Ill.

1990

Kathryn Davis, '74
Vice President, Marketing & Planning, Merritt and Harris, New York, N.Y.

Leroy E. Kendricks, '77
Pres. and CEO, Integrated Controls and Computer Systems, Inc., Champaign, Ill.

1991

Jerry H. Hogan, '59
Retired Lt. Colonel, U.S. Army, Vice President Engineering, MCI, Richardson, Tex.

1992

Thomas E. Prickett, '60
Consultant, Groundwater Research, Aquifer Evaluation, Champaign, Ill.

1993

Louis J. Mancini, '72
Vice President, Engineering and Fleet Operations, Northwest Airlines, Inc., St. Paul, Minn.

1994

Paul Rimington, '67
President and CEO, Diemasters Manufacturing, Inc., Elmhurst, Ill.

1995

Nancy Jakse, '74
Vice President Quality, Anheuser-Busch/Metal Container Corp., St. Louis, Mo.

In 1983, Gamma Epsilon established the Outstanding Professor Award presented each spring to the outstanding faculty member. The selection is made by the vote of the graduating seniors. The award carries with it a certificate and a cash award of \$500. The award winners are as follows:

- 1982-83 — L. Daniel Metz
- 1983-84 — Edward N. Kuznetsov
- 1984-85 — Louis Wozniak
- 1985-86 — James V. Carnahan
- 1986-87 — Michael H. Pleck
- 1987-88 — David C. O'Bryant
- 1988-89 — Scott A. Burns
- 1989-90 — Scott A. Burns
- 1990-91 — James V. Carnahan
- 1991-92 — Scott A. Burns
- 1992-93 — Thomas R. Woodley
- 1993-94 — Edward N. Kuznetsov
- 1994-95 — W. Brent Hall

In 1967, the General Engineering Constituent Alumni Association was organized. The group meets yearly and reviews the program of the department and assists in various activities such as fundraising. In that regard, the General Engineering Trust Fund was established in 1966 in the University of Illinois Foundation.

On November 14, 1962, a student chapter of the Illinois Society of Professional Engineers was established with Robert A. Jewett (joined the department in 1953) and David R. Reyes-Guerra as faculty advisers. The initial meeting of some 75 students from throughout the college joined as members. Jewett remained faculty adviser until his retirement in 1976, after which the student chapter of ISPE died out.

Departmental Awards

Beginning in 1963, a number of departmental awards were established. They are described below.

E. S. Fraser Award

The Fraser Award is given annually to the outstanding senior based on scholarship (70%) and activities (30%). The award was established in 1963 by Edward S. Fraser, BSCE '39, who was a senior vice president of Chicago Bridge and Iron Co. The winner's name is inscribed on a department plaque and an individual plaque. A \$500 award is also given to the recipient.

H. L. Marcus -L. B. Phillips Award

The Marcus-Phillips Award was established for a graduating senior in 1964 by Michael Phillips, a 1963 graduate of General Engineering, and his wife Judith Ann in honor of their fathers. The award was based on extracurricular activities (50%), activities outside the university (10%), professional organization (10%), peer rating (20%), and faculty rating (10%). The award carried a \$100 check, an individual wall plaque, and the name on a departmental wall plaque. Since the expenses of the award were paid by Michael Phillips rather than from an endowed fund, the award was last made in 1984. Attempts to contact the Phillipses as to their desire to continue the award failed, therefore, the award was discontinued.

R. P. Hoelscher Award

In 1968, in memory of former department head Randolph P. Hoelscher, an award was established by the Department of General Engineering. The award is given to an outstanding junior student with 60-89 hours excelling in scholarship (40%), activities (30%), and cultural breadth (30%). The award carries with it an individual certificate, \$100, and the name of the winner on a department plaque.

Bernt O. Larson Award

When Bernt O. Larson (BSCE '38), retired in the fall of 1974, due to illness, the Department of General Engineering established the Larson Award to recognize his inspirational leadership in the development of the senior project design course. The award is given each year to the best project design the previous year and carries a stipend of \$150 for each team member, plus a certificate and the names are inscribed on a department wall plaque. The second place team receives \$75 each.

Herbert J. Sprengel Award

Upon his retirement from the faculty in 1978, Herbert J. Sprengel established the Herbert J. Sprengel Award. Originally it was to recognize the outstanding freshman design either in GE 103 or GE 104. In 1983 the award was changed to recognize the best engineering design analysis for an outstanding GE 232 balsa wood design. The award consists of \$100 and a certificate.

Elizabeth Ruff Award

The Elizabeth Ruff award was established in 1985 by Marie Ruff in memory of her daughter who received a BS degree in 1983 and had been accepted to the general engineering master's degree program before her untimely death. Elizabeth Ruff was remembered most for her sincerity, unpretentiousness, consideration, and supportive nature. The award was made to a sophomore or junior woman with a 3.75 or higher grade-point average and the above qualities. The award carried a stipend of \$500 and a name inscription on a department wall plaque, and was sustained until 1995.

Jerry S. Dobrovolny Award

Upon his retirement in 1987, Jerry S. Dobrovolny (BSGE '43, MSME '47) with the help of his friends, estab-

lished an award to recognize outstanding leadership qualities in leadership for seniors in the Department of General Engineering. The criteria required at least 90 semester hours, a 4.0 academic average, and demonstrated leadership qualities in such activities as participation in student professional societies, campus organizations, faculty-student senate, off-campus organizations, legislative initiative, and other recognized efforts. The award carries with it a \$500 stipend, a certificate, and name inscription on a department wall plaque.

Mildred Mattux and Lisle Abbot Rose Scholarship

In 1995, Mildred Mattux Rose established a \$50,000 endowed scholarship to recognize outstanding general engineering sophomores or juniors to help them complete their next two semesters in the department with \$500 per semester. The criteria are based on academic accomplishment (70%), extracurricular activities (15%), and cultural breadth, including music, history, and the arts (15%). The endowment is in recognition of the contribution Lisle Abbot Rose made as director of engineering information and publications for the College of Engineering. He was a professor of general engineering.

William A. Chittenden Graduate Award

In 1985, the William A. Chittenden (BSGE '50), Graduate Award was established. It is given to an outstanding master of science graduate in general engineering who has demonstrated high-quality scholarship, research skills, teaching and/or research accomplishments, and professional promise. The award carries a \$1,000 stipend and a plaque.

Lincoln Arc Welding Foundation Awards, 1968-1994

Since 1968, the Department of General Engineering has entered the senior GE 242 undergraduate design projects in the National Student Engineering Design Competition sponsored by the James F. Lincoln Arc Welding Foundation. Entries there are judged on the basis of originality, feasibility, engineering competence, and results achieved or expected in product performance or cost.

Year	Title of Project	Students	Award	Prize	Faculty Adviser
1994	Design of a Two Position Turntable	Bruce T. Atkins Andrew Wang Brad J. Whitmore	Gold	\$1000	Mark W. Spong
	Drive-by-Wire Outboard Motor Throttle Control	David W. Ingram Tracey L. Meek Joshua M. Minnihan	Silver	\$750	Roland L. Ruhl

Lincoln Arc Welding Foundation Awards, 1968–1994—*continued*

Year	Title of Project	Students	Award	Prize	Faculty Adviser
	Experimental Study of Tool Life Enhancement	Donald L. Chamberlain Michael C. Gianasi David B. Halm	merit	\$250	Harry S. Wildblood
	Pelletizing Fly Ash for Use as an Agricultural Lime	Alejandra C. Cornejo Michael N. Kourinos Schy J. Willmore	merit	\$250	W. Brent Hall
	Protection of a Catalyst from Ash Particulates	Cary P. Bronson Monica B. Heckert Angela M. Riedi	merit	\$250	Angus Simpson
1993	Nondestructive Inspection of Stainless Steel Forgings	Kevin Coyle David Hyten Amit Patel	merit	\$250	Henrique L. M. dos Reis
1992	Design of a Device for Feeding a Person with Little or No Arm Control	Brian T. Fay	Silver	\$750	Mark G. Strauss
	Salvage of Molded Shafts for Frame Breakers	Victor Gamez Lisa Boreland John L. Acree	Bronze	\$500	W. Brent Hall
	Separation of Petroleum Contamination from a Nitrogen Stream during Pipeline Blowdown	Christine Fiore Kenneth J. Coulter Jeffrey A. Southard	Bronze	\$500	W. Brent Hall
	Motorized Table Height Adjustment Mechanism	Michael R. Gogola Tara L. Lloyd David R. Nebl	merit	\$250	Henrique L. M. dos Reis
	Bottom Ash Locator for a Water Impounded Hopper	Sassan Attari Ernest Gaertner Christine Shields	merit	\$250	Henrique L. M. dos Reis
1991	Heat Transfer Optimization of Refrigerator Condenser	Lawrence H. Chiang Mark E. English Mark E. Simek Gregory H. Wuerfel	Silver	\$750	Juraj V. Medanic
	Analysis and Design of a Quench Test Device	James Emery Dan Long Eric VanDerGraaf	merit	\$250	James V. Carnahan



Students (from left) Mark DePoorten, Jami Thornton, and Christopher Wyatt work on their 1995 Lincoln Arc Welding entry, a hose assembly modification sponsored by Testor Corp.

Lincoln Arc Welding Foundation Awards, 1968–1994—continued

Year	Title of Project	Students	Award	Prize	Faculty Adviser
1990	Redesign of Turbine Pump Testing Station	Andrew W. Majernik John C. Marchelya Charles T. Riggs Carolyn S. Strittmatter	merit	\$250	Mark G. Strauss
	Development of a Droplet Size Analysis Method Based on Volumetric Flux	Raymond J. Heino Karen A. Shineflug David W. Tarabozetti	merit	\$250	S. Daniel Thompson
	Improved Design and Assembly Process of the Circular MIL-C-5015 Electrical Connector	Donna M. Davis Michael S. Dillon Craig S. Hicks Evanthia Nafpliotis	merit	\$250	Henrique L. M. dos Reis
1989	Production Control System	John Kozel Tim Stuart Mike Snyder Greg Vyrda	merit	\$250	S. Daniel Thompson
1988	Software Development for Nondestructive Testing and Evaluation of Wood Products	Kent A. Miller Vivian M. Klick Michael J. Chica	Silver	\$750	Henrique L. M. dos Reis
	A Redesign of Steel Members in Stackable Files	Karen B. Ulstrup Maura A. Curry Dwight E. Krahn	merit	\$250	Weichien Chow
	Mathematical Modeling and Dynamic Analysis of the Rolling Piston Rotary Vane Compressor	Robert C. Kosberg Jeffrey M. Stokes Margaret S. Schneller	merit	\$250	Thomas F. Conry
1987	Design Optimization of a Reclining Chair Back Mechanism	Ethan Franklin John Lach Pamela Miller	2nd	\$750	Scott A. Burns
	Thermal Properties of Intercalated Graphitic Fiber Composites	Mun Young Choi Gabrielle Robinson Michele Wierman	merit	\$250	Henrique L. M. dos Reis
1986	Magnetic Circuit Calculation Algorithms	Scott W. Holmes John Q. Meyer Brett Johnson	merit	\$250	Thomas F. Conry
	Water Level Control Sensor for a Computer Controlled Washing Machine Interface	Steve Dowd Annette Drilling Roman Krus	merit	\$250	Rodney D. Hugelman
1985	Analysis of "Safe Torque" Tap Driver	Gerald J. Close Scott Farnham	merit	\$250	Edward N. Kuznetsov
	Computer Simulation of Throttle Control System	R. Patterson Harnet Warren A. James Bradley G. Lane	merit	\$250	Howard K. Knoebel

Lincoln Arc Welding Foundation Awards, 1968–1994—*continued*

Year	Title of Project	Students	Award	Prize	Faculty Adviser
1984	Critical Speeds of a High-Speed Generator Rotor	Joseph A. Kann Thomas A. Mulholland Paul H. Verstrate	merit	\$100	Henrique L. M. dos Reis
1983	Control System for a Gas Metal Arc Welding Process	Andre J. Quattrochi Casey T. Schlachter Michael J. Wolff	1st	\$1,000	Henrique L. M. dos Reis
	Residual Stress Characterization in Hardboard	Michael H. Lehmann Samuel C. Papandreas Kelly Shoemaker John H. Waldron	merit	\$100	Henrique L. M. dos Reis
1982	Quality Assurance Voice System	Carl Alde Richard Bourke Susan Julian	4th	\$250	Dominic O. Skaperdas
	New Rim Design for Large Earthmover Tires	Richard T. Cartwright Douglas C. Reeves Brian Walters	merit	\$100	Henrique L. M. dos Reis
1981	An Improved Design for a Rotary Die	Brian Lilly James P. Danielson James E. Marshall Michael Prokop	merit		Henrique L. M. dos Reis
	A Production Anneal Tester for Electrical Contacts	Joseph A. Jaeger Thomas J. Marseille Clare E. Strebel Stephen Strebel	merit		Rodney D. Hugelman
	No. 6-32 Screw/Captive Wire Clamp Plate Fastener	Jayne Glemza Brad Gregor Tom Anderson Jim Anfield	merit		Charles Gebhardt
1980	Design of a Low-Cost Load Cell	Douglas P. Goetz Bruce A. Krandel David A. Thompson	4th	\$250	Charles Gebhardt Henrique L. M. dos Reis
	FMC Pin Sorting Machine	David Adams Rohn R. Donovan Eugene W. Kiesel	4th	\$250	W. Brent Hall
	A Computer-based Exercise Bicycle	Brian G. Eberle Jeffery M. Frame John C. O'Conner Thomas R. Orgler	4th	\$250	Roland L. Ruhl
1979	Design of a Roof-Plate Laying Vehicle for Fuel Storage Tanks	Ronald M. Monsen Julius F. Nemeth David R. Scuby	2nd	\$750	Morris Scheinman
	Design Synthesis of a Portable Roofing Hoist	Dawn L. Cannell Thomas D. Futter Michael R. Huber Rosemarie F. Orehek	3rd	\$500	Subramanian Ramamurthy Roland L. Ruhl
	Fluidically Controlled Industrial Robot	Duane F. Campbell James R. Gunnison Joseph P. Hirt Bradley D. Mottier	4th	\$250	Rodney D. Hugelman

Lincoln Arc Welding Foundation Awards, 1968–1994—*continued*

Year	Title of Project	Students	Award	Prize	Faculty Adviser
1978	A Two-Way Weld Positioner	David H. Coyle John A. Notardonato Steven D. Rak Gary R. Steere	2nd	\$750	Rodney D. Hugelman
1977	A Part Sorting and Loading System	William C. Chedister James H. Christensen James R. Johnstone II Daniel J. Lambert Anthony G. Riley	4th	\$250	Rodney D. Hugelman
	Redesign of a Mine Roof Bolter to Permit Inclined Bolting	Robert Brown Shauna Clarke Mark Stefanik Mark White	4th	\$250	Morris Scheinman
1975	A Differential Settlement Compensating Pipe Anchor	David E. Olson Robert M. Burns Perry C. Hendrickson	4th	\$250	Morris Scheinman Thomas F. Conry
1974	Design of a 50-Ton Guyless Derrick	Kathryn A. Davis Andrew M. Stefanik Marvin C. Wildenract	1st	\$1,000	Morris Scheinman Bernt O. Larson
1973	A Bridge Replacement for a Deteriorated Sewer Line Crossing	W. Peter Siems	4th	\$250	Bernt O. Larson
1972	Improved Braking System for Paraplegic Wheelchairs	James J. D'Orazio Scott L. Jeffrey David K. C. Robbins	2nd	\$1,000	Herbert J. Sprengel
1971	Elastic Springback in Rolled Sections Cold Formed in a Die	John A. Turner Ronald Rutger Charles Fellmann	4th	\$1,000	Morris Scheinman Charles Gebhardt
1970	High-Speed Mass Transportation from O'Hare Field to Midway Airport	Andres Maneks James Harris	2nd	\$500	Bernt O. Larson
1968	Design of a Vehicle for Expressway Operation by a Quadriplegic	Gary Fariss Burr Logeman	2nd	\$1,000	Morris Scheinman

The 1972 second place Lincoln Arc Welding Award winners David Robbins, Scott Jeffrey, and James D'Orazio are shown at the presentation with Dean D. C. Drucker (left), J. S. Dobrovolny, and faculty adviser Herbert J. Sprengel (far right).

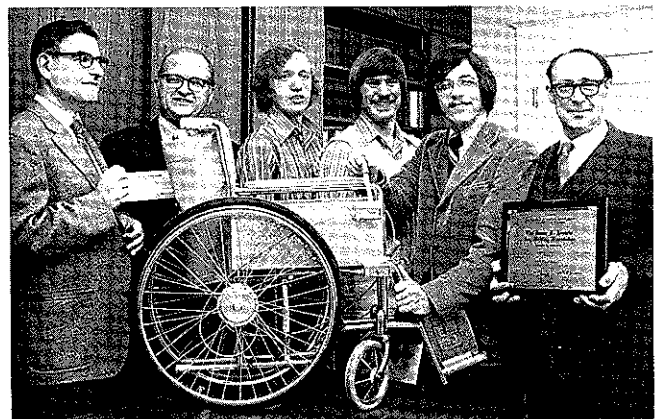

Chapter 7

Contributions to Engineering Technology Education



In 1952, Jerry S. Dobrovolny attended the annual meeting of the American Society for Engineering Education (ASEE) held at Dartmouth College where he delivered a paper. While there, he heard Dean Hollister of Cornell University give a talk on the need for training technicians to assist the engineer in the more routine tasks associated with an engineering enterprise. Upon his return to the campus, Dobrovolny went to the library to search out more information about technical institute-type education. There was little to be found in the literature except the William E. Wickenden and Robert H. Sparks report entitled, "A Study of Technical Institutes 1931" for ASEE, and the 1956 Leo F. Smith and Lawrence Lipsett book *The Technical Institute*. The authors were from the Rochester Institute of Technology.

To become better informed, Dobrovolny began to attend the Technical Institute Division Meeting of ASEE (established in 1941). During this period the term "technical institute-type" of education was widely used with no accepted definition to cover the field. About the only universally accepted concept was that it was post-secondary, requiring high school graduation. Even though the Engineers' Council for Professional Development (ECPD) began to accredit technical institute programs in 1944, there were no standards in use. Most of the technical institutes at that time were private proprietary organizations.

Many different forces existed in the 1950s that brought attention to the need for technicians. The interstate highway system in 1956 generated the need for semiprofessional personnel on the engineering manpower team. In 1956-57, the state highway departments of Illinois and California established job titles for engineering technicians. Various professional organizations established committees on engineering technicians; among these were the National Society of Professional Engineers and the American Society of Civil Engineers.

The College of Engineering recognition of the need for technicians was called to the attention of university president David D. Henry by Dean W. L. Everitt in a memo dated January 28, 1957, in which he stated the need for "technical institute programs of major size...(to

prepare) the numbers of technicians and engineering aides required...estimated at three to four times the number of professional engineers."

On October 4, 1957, the President's Committee on Scientists and Engineers reported to the President of the United States the following:

"A major factor in the conservation of scientific and engineering skills is the effective use of highly qualified technicians....Members of the President's Committee are unanimous in the belief that the shortage of technicians is at least as severe as the shortage of scientists and engineers, and that their lack contributes materially to the under-utilization of scientists and engineers."

During the spring semester of 1958, Dobrovolny was released from teaching at the request of Dean Everitt to conduct a study to determine the engineering technician needs of the state of Illinois. The study was jointly funded by the College of Engineering and the University Extension Division. Robert L. Johnston of the Extension Division assisted in gathering data.

One important source of data was the 1957-58 ASEE National Survey of Technical Institute Education being conducted by G. Ross Henninger, supported by a grant from the Carnegie Corp. of New York. The survey was published in 1959 by McGraw-Hill Book Company, Inc. Dobrovolny visited with Henninger in the spring of 1958 and submitted his report in May 1958 entitled, "The Role of the University of Illinois in the Development of Technical Institutes." In it he recommended the establishment of 10 state-supported technical institutes in the state of Illinois located at various industrial centers.

On October 24, 1958, Everitt wrote a memo to Royden Dangerfield, chairman of the Committee on the Future Growth and Development of the University Extension Division about the action taken by the College of

Engineering Executive Committee on October 20, 1958, with respect to the role the university should play in the establishment of technical institutes in Illinois. The two-page memo recommended the establishment of technical institutes in various industrial areas. The program was to be administered jointly by the Extension Division and the College of Engineering. As a follow-up to this memo, Dangerfield requested a group from engineering meet with his committee on December 19, 1958, to discuss the questions of technical institutes. Dobrovolny, E. L. Broghamer (Mechanical Engineering), and D. S. Babb (Electrical Engineering) were among those from the college who were invited.

Although the University of Illinois was not able to follow through on the recommendations made by the College of Engineering, other developments in the Office of the Superintendent of Public Instruction provided an opportunity for College of Engineering to provide guidance to the state office in the evaluation of prospective technical institute curricula. The state office created two new positions: one to supervise junior colleges, and the other to supervise technical education.

On November 16, 1959, Harry A. Meinert, state of Illinois supervisor of trade and industrial education, Walter J. Bartz, supervisor of technical education, and R. O. Birkhimer, supervisor of junior colleges, met with Dobrovolny to discuss technical institute education. Bartz requested the College of Engineering act as a counseling agency on proposed technical institute curricula being submitted to his office for approval.

As a result of this request, on November 25, 1959, the dean appointed the Technical Institute Curriculum Advisory Committee. The first meeting of the committee was held on January 18, 1960, with the following members:

- D. S. Babb, Electrical Engineering
- C. E. Bowman, Theoretical and Applied Mechanics
- E. L. Broghamer, Mechanical and Industrial Engineering
- J. S. Dobrovolny, chair, General Engineering
- G. R. Eadie, Mining Engineering
- W. W. Hall, Civil Engineering
- R. S. Jensen, Theoretical and Applied Mechanics
- R. L. Johnston, University Extension
- R. W. McCloy, Aeronautical Engineering
- D. D. Perlmutter, Chemical Engineering
- J. E. Williams, Electrical Engineering
- R. R. Yoerger, Agricultural Engineering

Some of the early considerations of the committee were to visit as many technical institutes as possible when members were on other trips. The role of the committee in the development curricula and teacher preparation programs was of highest priority.

On December 19, 1960, Chairman Dobrovolny wrote a memo to the College of Engineering Policy and Development Committee pointing out the need for providing additional training for technical institute teachers. It also noted that plans were underway to inaugurate a master's degree for the training of technical institute teachers.

On October 11, 1961, a conference was held in President Henry's office to discuss the role of the university with development of post high school educators in Illinois. Babb, Broghamer, and Dobrovolny were present.

Development of Criteria

Although the Engineers' Council for Professional Development accepted the responsibility for the accreditation of technical institute curricula in 1944, there were no formal criteria to use as a guideline. To help clarify this situation, ASEE, in 1961, received a grant from the National Science Foundation to conduct a study to formulate a set of educational criteria for those programs identified as technical institute type. James L. McGraw was named the project director. The report submitted in 1962 was entitled, "Characteristics of Excellence in Engineering Technology Education."

It was apparent that much work needed to be done to develop two-year associate degree curricula, course outlines, the level of mathematics to be taught, the preparation of teachers, the role of the community college in teaching engineering technology programs, and a host of other items.

The importance of preparing qualified engineering technicians was further identified by the Congress when it enacted the National Defense Education Act (NDEA) of 1958. Title VIII of the act states:

"It is therefore the purpose of this Title to provide assistance to the states so that they may improve their vocational education programs through area vocational education programs approved by the State boards of vocational education ..."

The term "area vocational education programs means a program of one or more less-than-college-grade courses conducted under public supervision and control on an organized, systematic class basis, which is designed to fit individuals for useful employment as technicians or skilled workers in recognized occupations requiring scientific or technical knowledge, ..."

The National Science Foundation also was aware of the need for qualified technicians. It established a program to fund summer institutes and academic year institutes to upgrade teachers teaching in technician programs.

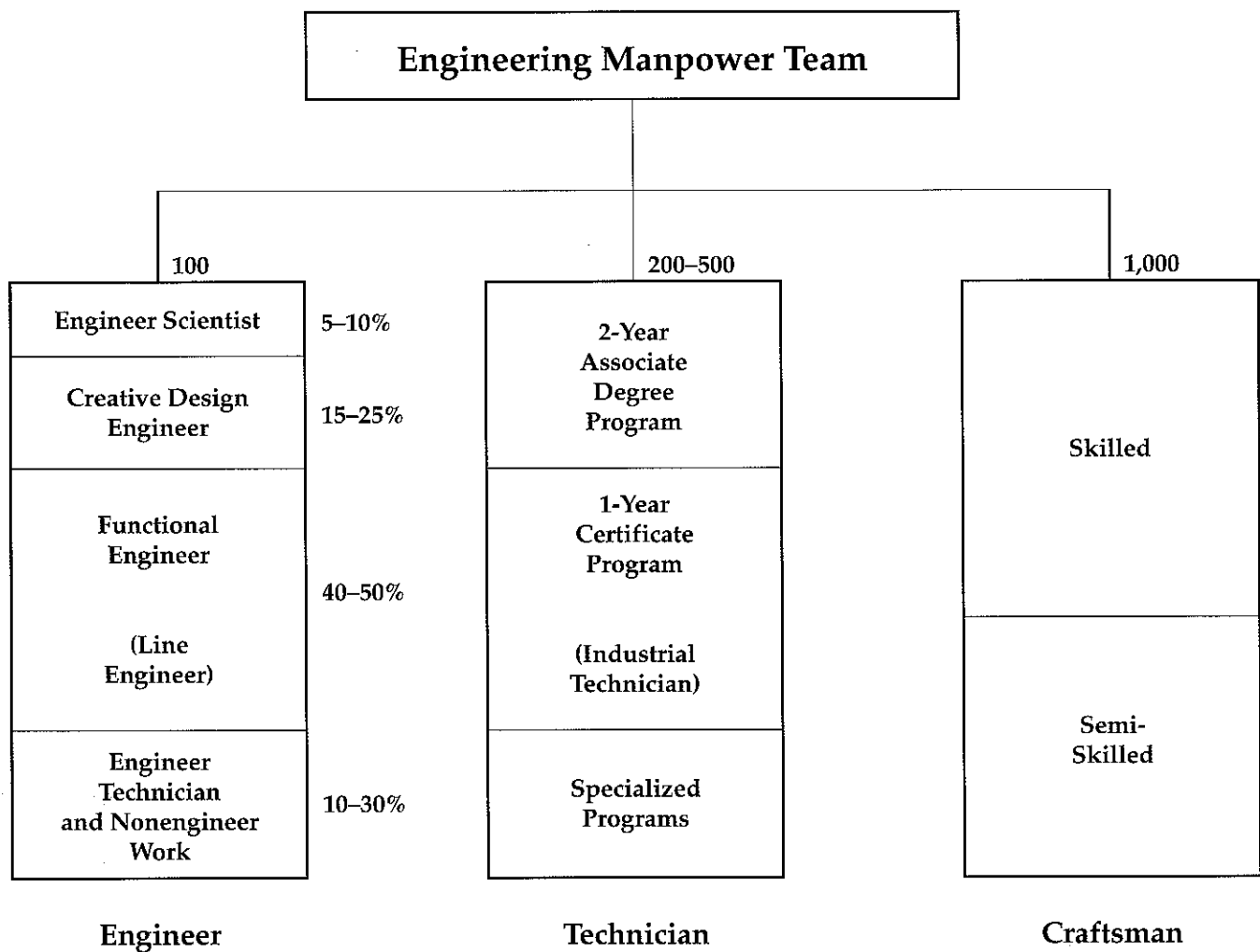

Figure 7

The U.S. Office of Education and its Division of Vocational Education mounted a program to identify post-secondary technical education programs. They held national conferences in the late 1950s and early 1960s that urged the various states to move their vocational education programs (under Title VIII of NDEA 1958) toward training technicians.

The involvement in the technical education movement by Dobrovolny and the other members of the College of Engineering Technical Institute Curriculum Advisory Committee was wide and instrumental in establishing national standards for two-year associate degree programs.

Early in the committee's consideration was the level of mathematics to be taught. Under the leadership of R. J. Placek of General Engineering, two five-semester-hour courses were developed that were calculus-based. In the late 1950s there were 15 junior colleges in Illinois that were associated with their respective high school districts.

Under Title VIII of NDEA, the State Board of Vocational Education appointed Walter E. Bartz to implement the program in the state of Illinois. He came to Dobrovolny (see above) for advice and the two scheduled a series of meetings throughout the state to identify the types of programs to be structured in the various junior colleges. It was at these meetings that the calculus-based mathematics courses were presented. It was quite a challenge at the time working with vocational educators because they were not familiar with mathematics-based technical education. These meetings were conducted in 1960 and 1961.

To help in understanding where the two-year associate degree engineering technician would fit into the engineering manpower team, Dobrovolny developed a chart (Figure 7) showing the slot. At the same time, the

U.S. Office of Education, Division of Vocational Education, headed by Walter E. Arnold, was conducting a series of national regional meetings in various states to explain the intent of Title VIII of NDEA 1958. Dobrovolny was invited to present the ideas that were being developed in Illinois, including the concept of the engineering manpower team he developed. This proved to be extremely important when presented to old line vocational educators because it pointed out that the vocational education programs were not being replaced. The new programs were in addition to what was in place. It was in these various meetings that Dobrovolny began to identify these programs as engineering technology programs to differentiate them from vocational education and technical institute types of programs.

In the spring of 1962, the above mentioned ASEE study directed by James L. McGraw held five regional conferences addressing the criteria to be used in evaluating two-year associate degree programs in engineering technology. The last of these was held in Chicago, Illinois, and was attended by members of the College of Engineering Committee on Technical Education. The two main stumbling blocks that had occurred at the other four meetings were the level of mathematics and the name of the technical education program. The outline of the two mathematics courses that were being discussed in the state of Illinois were distributed and discussed. It was these courses that helped in determining the criteria that were then reported in the study. With respect to the name, here again in Illinois the new programs were being called "engineering technology" rather than "technical institute" type of programs. When the report was issued in 1962, it was entitled, "Characteristics of Excellence in Engineering Technology Education." The College of Engineering committee made a significant contribution in the embryonic stages of the engineering technology movement.

Teacher Education

One of the early considerations of the College of Engineering Technical Institute Advisory Committee in 1959 was the competency of the teachers to teach in the technician programs being offered in community colleges. In the late 1950s, the National Science Foundation established a program to upgrade teaching in mathematics and science. It was under this program that Dobrovolny, with the cooperation of the Technical Institute Advisory Committee (later changed to the Engineering Technology Curriculum Advisory Committee), submitted a proposal for an 8-week summer institute. The proposal was funded for the summer of 1961 to bring to

campus 15 teachers of machine design technology and 15 teachers of electronics technology. In total, 11 such summer institutes were funded by NSF from 1961 through 1971. In addition, 5 academic year institutes also were funded by NSF from 1963 through 1968. Over 500 teachers from across the United States were able to attend these programs.

As a result of the experience gained conducting these teacher training institutes as early as December 19, 1960, Dobrovolny wrote a memo to the College Policy and Development (CP&D) Committee outlining the need for a master's degree for the training of technical institute teachers.

On April 21, 1961, the Technical Institute Curriculum Advisory Committee submitted a proposal to the Graduate College through CP&D for the establishment of a master of science degree in the teaching of engineering technology. On April 26, 1961, CP&D approved 20 courses in engineering technology for the implementation of the April 21, 1961, proposal. The proposal was forwarded to the Office of the Provost.

As a result of the October 11, 1961, conference with President Henry about the role of the university in the development of junior colleges, a position paper was developed and circulated November 9, 1961, with the statement: "We pledge continued efforts toward the preparation of junior college teachers."

At the president's 5th Faculty Conference at Robert Allerton Park, March 23-25, 1962, conference resolution number 7 adopted the following:

"The University should actively encourage the development of Technical Institute Programs and other Technological Programs, within the framework of the community colleges, throughout the State. The University should accept responsibility for training faculty of such programs."

Following the conference, Provost Lyle H. Lanier, at the request of the University Council on Teacher Education, appointed an ad hoc committee on the education of teachers for junior colleges. Part of the charge of the committee was as follows:

"You probably know that there are two major types of junior-college education: (a) the initial two years of a standard four-year college program, partly devoted to general education; (b) a terminal program in technical education. The 'comprehensive' junior college includes both programs. Your Committee is asked to study the objectives, needs, and special problems related to the training of teachers for both aspects of junior-college education — with a view to recommending appropriate policies and programs for the University of Illinois."

Members of the committee were:

H. S. Broudy, Education
J. S. Dobrovlny, General Engineering
Bruce Harkness, English
W. R. Horsfall, Entomology
M. R. Karnes, Education
Joseph Landin, Mathematics
Robert Siegfried, Chemistry
I. D. Steiner, Psychology
C. P. Viens, French

Since the new committee for junior college teachers was appointed, Dean F. T. Wall of the Graduate College turned down the proposal from the College of Engineering for a Master's Degree in the Teaching of Engineering Technology on May 7, 1962.

On February 15, 1963, the ad hoc Committee on the Education of Teachers for Junior Colleges reported the following recommendations with respect to the training of prospective teachers of technical courses:

- "1. The Committee recommends that the University establish undergraduate programs for teachers of engineering-related specialties. At a later date, programs for instructors in other technical fields (health and medicine, business and commerce, agriculture, etc.) also should be considered.
- "2. Current joint efforts of the College of Engineering and the College of Education to develop undergraduate programs for the preparation of post-high school technical subjects should be continued.
- "3. In planning such programs every effort should be made to utilize existing courses and to avoid creating new ones. In the Committee's view, new specialized technical courses should not exceed ten or twelve semester hours in any program.
- "4. Programs should place a major emphasis on mathematics and sciences.
- "5. Many prospective students will be graduates of two-year, post-high school technical programs. Consequently, curricula at this University should, where feasible, be coordinated to the programs offered by other institutions.
- "6. Since high-level industrial experience is assumed to be extremely important to the instructor of post-high school technical subjects, such experience should remain a prerequisite to employment as an instructor, and it is urged that cooperative industrial training be included as an integral phase of all programs.

"7. Although the programs envisioned by the Committee are undergraduate in character, it is recognized that a few courses at the 300 level will be needed. Students should be admitted to such courses only after they have satisfied specific prerequisites."

The report further recommends programs for those presently teaching courses in junior colleges:

"The Committee proposes a flexible program of course work which will lead to a 'Certificate in the Teaching of Engineering Technology'."

At the April 19, 1963, meeting of the University Council on Teacher Education, the report of the ad hoc Committee on the Education of Teachers for Junior Colleges was considered. The action of the council as quoted from the minutes of the meeting is as follows:

"The Provost suggested appointing a committee to make detailed proposals in harmony with the section of the report dealing with the preparation of teachers of technical courses in junior colleges. The report should propose the program, courses, staff and space, together with any other elements related to cost, and the probable costs, both non-recurring and recurring.

"A motion requesting the appointment of such a committee was passed. A motion also was passed requesting that the committee give consideration to placing the undergraduate programs for preparing teachers of engineering technology in the College of Engineering."

On June 6, 1963, the University Council on Teacher Education appointed a committee on the Preparation of Teachers of Engineering Technology. The committee members were as follows:

G. M. Almy, Physics
D. S. Babb, Electrical Engineering
E. L. Broghamer, Mechanical and Industrial Engineering
J. S. Dobrovlny, chair, General Engineering
M. R. Karnes, Education
R. J. Placek, General Engineering
W. J. Schill, Vocational and Technical Education
J. Stern, Industrial Education

The committee was charged as follows:

"You are asked to study the section of the report referred to and propose a suitable curriculum. The latter would include whatever new courses might be required. The staff, the space, and the new equipment needed also should be specified. It will be helpful if your committee also would estimate the probable costs of such a program — both the capital costs (including equipment) and the annual operating costs.

"This program presumably would be administered by the College of Engineering and the corresponding degrees granted by that College. But the committee is free to consider whether or not the curriculum should be limited to students matriculated in that College. In any event, requirements for admission should be included among your recommendations."

On November 27, 1963, the Committee on the Preparation of Teachers of Engineering Technology submitted its report to Provost Lanier, chairman of the University Council on Teacher Education. The report recommended the establishment of an undergraduate program, as well as a post baccalaureate certificate in the Teaching of Engineering Technology. Preliminary curricula were included in the report. On January 28, 1964, the University Council on Teacher Education accepted the report and instructed the coordinator of the council to discuss the procedural aspects of implementing the recommendations with Dean W. L. Everitt

On March 10, 1964, Dobrovolny, acting as chairman of both the Engineering Technology Advisory Committee and the University Council on Teacher Education Committee on the Preparation of Teachers of Engineering Technology, submitted an undergraduate program in the Teaching of Engineering Technology and a post-baccalaureate certificate in the Teaching of Engineering Technology to CP&D. The proposal was approved by CP&D and forwarded to the faculty of the College of Engineering at its October 22, 1964, meeting, at which both programs were approved.

As a result of this action the Post Baccalaureate Certificate in the Teaching of Engineering Technology was approved in 1965. The participants of the NSF-sponsored Summer Institutes and Academic Year Institutes were able to qualify for this advanced certificate and a total of 20 were awarded in 1966.

Technician Need Studies

The rapidly changing engineering related technician manpower needs in the early 1960s left many questions unanswered. One of these was just what kind of technicians were needed and what kind were actually in practice. In 1962–63, the Illinois Board of Vocational Education, under Title VIII of NDEA 1956, awarded a grant to J. S. Dobrovolny to conduct a technician need study in Vermilion County, Illinois. Christy A. Murphy was selected as project director.

One of the outcomes of this study was the identification of an electromechanical technician. The other types were chemical, mechanical, electrical, and electronics technicians. The employers recognized the need for many more technicians in the next five years.

A similar study was funded in 1964–65 for Lake County, Illinois. Here again, the needs were well documented for engineering-related technicians. The projected technician needs echoed the findings in the Vermilion County study.

Curriculum Development

With the Characteristics of Excellence in Engineering Technology Education Report of ASEE outlining the depth of coverage in the various subject matter areas, there was a need to translate these recommendations into meaningful curricula. Dobrovolny submitted a proposal to the U.S. Office of Education in 1962 to develop curriculum guides for a training program to prepare highway engineering aides and for a two-year post-secondary associate degree program in civil technology. The proposal was approved and funded in 1962. The suggested guides were published in 1963 by the U.S. Office of Education.

In 1962–63, the Illinois Board of Vocational Education funded a project to develop a two-year associate degree program in machine design technology with Dobrovolny as director. The guide was the first in a series that followed in subsequent years as follows:

1963	Machine Design Technology	4 semesters	Series 1
1964	Electronics Technology	4 semesters	Series 2
1967	Electronics Technology	6 quarters	Series 3
1968	Machine Design Technology	6 quarters	Series 4
1970	Electronic Power Technology	6 quarters	Series 5
1971	Mechanical Power Technology	6 quarters	Series 6

To assist in developing the electronic power technology curriculum guide published in 1970, a two-day education industry conference on manpower training and development for the guide, was held February 22 and 23, 1966. The conference, coordinated by Dobrovolny, was held in order to obtain essential, practical, and first-hand information to assist in the development of a two-year

curriculum guide. There were 76 participants attending and included representatives from industry, community colleges, universities, U.S. Office of Education, Illinois Division of Vocational Education, and publishing companies.

A similar conference was held April 13 and 14, 1971, to discuss a possible new educational program in mechanical power technology. Here again, the participants were from a wide range of personnel including industry, education, and government agencies.

Micro-Precision Research Project

On April 14 and 15, 1965, a significant manpower conference was held for the watchmaking and precision industries. Dobrovolny was the conference coordinator. The participants included members of the Instrument Society of America, educational specialists both in public and private schools, representatives from government agencies, members of the American Watchmakers Institute, and selected individuals from the defense industries using employees with horological skills. Hugh G. Wales, Department of Marketing, was instrumental in identifying the knowledgeable persons in the field.

The conference proceedings brought out the fact that most of the manpower training in this field was being conducted by proprietary institutions more or less on an apprenticeship basis. There were no established curricula to draw from to train the type of technicians needed to do microprecision work in the defense industry. The need for microprecision technicians with a mathematics-science base with horological skills was identified overwhelmingly by the participants of the conference.

In 1965, a proposal was submitted to the U.S. Office of Education for a grant to develop two curriculum guides, to design and assemble laboratory equipment to be used in teaching, and to conduct a one-year demonstration project with 25 students. This project was funded in 1966 and completed in January 1968. The one-year curriculum guide was on horology and the two-year guide was on microprecision technology. William O. Smith, Jr., was employed as a research associate to coordinate the purchase of laboratory equipment and the development of the instructional material. Wales provided the contact with industry representatives and the equipment manufacturers. Dobrovolny was the overall director of the project.

The project was a huge success in that it demonstrated the feasibility to train microprecision technicians in an academic environment. At the conclusion of the project, Dobrovolny obtained permission to transfer the laboratory equipment to a community college. The laboratory was transferred to Parkland Community College

in Champaign, Illinois. Smith went with the program as director and stayed with it until his retirement. The program is still on-going, preparing outstanding technicians.

Electronic Technology Development Project

In 1968, Dobrovolny and Daniel S. Babb from the Electrical Engineering Department and a member of the Engineering Technology Curriculum Advisory Committee received a grant from the National Science Foundation to develop material to be used by the instructors in the electronics technology programs. Babb was the project director with a project staff made up of persons who had been participants in the NSF Summer Institute and Academic Year Institute and were then department heads or head instructors of electronic technology programs in their respective community colleges. They were as follows:

- Ray E. Engelland, Willmar Area Vo-Tech Institute, Willmar, Minnesota
- Joel D. Gallaway, Parkland College, Champaign, Illinois
- David A. Peterson, Alpena Community College, Alpena, Michigan
- Randall L. Thompson, NSF Fellow, University of Illinois, Urbana, Illinois

A steering committee from other community colleges was used extensively to test the instructional material in the classroom. Here again, the instructors were former participants of the above-mentioned NSF institutes. They were as follows:

- Carrol W. Livesay, Lakeland College, Mattoon, Illinois
- Roger A. Mussel, William Rainey Harper College, Palatine, Illinois
- Eric S. Ruby, Sauk Valley College, Dixon, Illinois
- Neal D. Voke, Triton College, River Grove, Illinois
- Felix H. Wheeler, Danville Junior College, Danville, Illinois
- Robert T. Wilson, Illinois Central College, East Peoria, Illinois

The final report was published in 1971 and was widely used throughout the community colleges in the United States. Many of the people working on the project went on to become department heads and deans of technology, and a few became presidents of community colleges and four-year technical colleges.

Other Technical Education Involvements

As a result of the various activities, Dobrovolny, on behalf of technical education in the late 1950s and early 1960s, was appointed to a large number of state and national committees and projects.

Superintendent of Public Instruction. Dobrovolny was appointed by Ray Page, the state superintendent of public instruction, to his advisory committee. He served on that committee from 1963–69 advising on technical and vocational education.

Technical Education Act of 1963. Title VIII of NDEA 1958 provided matching funds for post-secondary laboratory funds to the various states. Since the state of Illinois, at that time, had only 15 junior colleges, which were extensions of the local high school districts, insufficient funds were available from the local districts to match the state funds. Dobrovolny, working through his association with Ray Page, superintendent of public instruction, Walter Bartz of the Division of Vocational Education, Senator Everitt R. Peters and Representative Charles Clabaugh of the Illinois legislature, and others, were able to get passed the Technical Education Act of 1963, whereby each dollar from the local school district would be matched with a dollar from the state to be used as matching funds for two dollars from Title VIII of NDEA 1956. This enabled the junior colleges to obtain three dollars for each one dollar to purchase laboratory equipment. There was a great increase in the number of post-secondary technical education programs started in the 15 junior colleges.

Community College Act of 1963. With the passage of the Technical Education Act of 1963, the same persons and others put together an effort to pass the Community College Act of 1963. The act provided state funds for the support of community colleges that would have at least 15 percent of their course offerings in technical education programs. There also was a requirement that these tech-

nical education programs be in 5 different areas. The community colleges were to be separate school districts covering several counties with an adequate assessed tax base and an adequate population base. Dobrovolny was involved in writing the legislation as well as serving as a consultant to a number of community college districts as they were being formed.

Technical Education Research Center (TERC). In 1965 a group of individuals organized a not-for-profit organization called the Technical Education Research Center in the state of Massachusetts. The purpose of TERC was "to instigate, initiate, and implement various research activities related to the entire spectrum of technical and vocational education." The home office was in Cambridge, Massachusetts, with other subsequent offices in Washington, DC; Waco, Texas; Champaign, Illinois; Springfield, Massachusetts; and Stillwater, Oklahoma. Dobrovolny was a director of TERC and office manager of the Champaign, Illinois, office.

Midwest Education Research, Evaluation, and Testing (MERET). In 1975, Dobrovolny converted the TERC Champaign, Illinois, office to the Midwest Education, Research, Evaluation, and Testing Center chartered in Illinois. Among the studies conducted by MERET was an evaluation of the program approval process in Illinois community colleges. This study was funded by the Illinois Advisory Council on Vocational Education. The corporation was dissolved in 1987.

Definition of Technical Education

In 1966, Dobrovolny was appointed by the National Center for Educational Statistics of the U.S. Office of Education to chair a committee to develop a definition of technical education. The committee met June 20–22, 1966, and submitted the following definition:

"Technical Education is concerned with that body of knowledge organized in a planned sequence of classroom and laboratory experiences usually at the post-secondary level preparing students for a cluster of job opportunities in a field of technology. It requires a knowledge of mathematics, the sciences associated with the technology; an understanding of the methods, skills, materials, and processes commonly used in the technology; an extensive knowledge of a field of specialization; and sufficient depth in the basic communication skills and related general education topics. Technical education prepares for the occupational area between the skilled employee and the professional employee such as the doctor, the engineer, the scientist; and is on the continuum nearest to the professional employee.

"The technical curriculum must be structured so that it prepares the graduate to enter a job and be productive with a minimum of additional training after employment to provide him with a background which will enable him to advance with the developments in the technology, and to enable him with a reasonable amount of experience and additional education to advance into positions of increased responsibility.

"The technician is usually employed in direct support of the professional employee. For example, the engineering technician will be capable of performing such duties as designing, developing, testing, modifying of products and processes, production planning, writing reports, preparing estimates; analyzing and diagnosing technical problems by applying his background in the technical specialties—mathematics, science, and communicative skills."

American Technical Education Association. Jerry S. Dobrovolny was very active in the American Technical Education Association (ATEA), through which a number of diverse groups who were interested in technical education were brought together. He served as trustee (1964–67, 1969–74), vice president (1966–67), president (1967–69).

State Advisory Council on Vocational Education. In June 1969, Governor Richard B. Ogilvie appointed Dobrovolny to the state of Illinois Advisory Council on Vocational Education. The council had 21 members as required by Title VIII of NDEA 1958. In 1973, Dobrovolny was reappointed for one year as chair by the newly elected Governor Daniel Walker to provide some continuity in the council, because the other 20 members were new to the council.

On May 4–5, 1972, the council organized a Governor's Symposium on Vocational Education at the Palmer House in Chicago, Illinois. The symposium brought together recognized leaders, both within and outside the state, from a diverse spectrum of society with many shades of opinion. The symposium had as its major aims:

1. To define the major problems and opportunities that will challenge the state of Illinois over the next 10 to 15 years;
2. To clarify the state's purposes and objectives that must inspire and direct the meeting of such great challenges;
3. To develop a framework of concepts and principles on which policies and decisions can be soundly based.

National Advisory Council on Vocational Education. On July 17, 1970, President Richard M. Nixon appointed Jerry S. Dobrovolny to the 21-member National Advisory Council on Vocational Education. The term was for three years. Dobrovolny was able to bring a unique perspective to the council with respect to technical education because of his wide involvement in its development. Most of the other members of the council were from fields other than education.

The council met once a month in various states to study the educational problems in the various states.

American Society of Civil Engineers. In 1969 the American Society of Civil Engineers established a committee on civil engineering technicians. Dobrovolny was appointed as its first chairman. The committee studied the role of the technician on the Engineering Manpower team. The concept developed by Dobrovolny in 1960 was adopted.

American Association of Community and Junior Colleges (AACJC). The rapid growth of the community college movement in the late 1960s and early 1970s necessarily had a focus on technical education. As has been pointed out earlier, civil engineering technology was one of the early programs developed. Dobrovolny was asked by AACJC to conduct a workshop on civil technology on May 17–19, 1967, in Atlanta, Georgia. Representatives from labor, industry, government agencies, publishers, and educators were involved in the workshop.

American Association for the Advancement of Science (AAAS). In 1968 the Commission on Science Educators of the American Association for the Advancement of Science stated "The need for educating larger numbers of highly trained technicians in reaching the critical stage, and there is as much now for national concern about technical educators as there was for concern about education of scientists and engineers two years ago." A Task Force on Technical Education of the Commission on Science Educators invited Dobrovolny to organize a symposium on some of the basic problems of technical educators to be held December 29, 1968, at the annual meeting of AAAS in Dallas, Texas. The symposium was co-sponsored by AAAS, ATEA, and AACJC. The papers were published as a monograph by AAAS.

Governor's Advisory Committee on Coal Manpower. In the spring of 1974, Governor Daniel Walker appointed a coal manpower committee through the Office of Manpower and Human Development. Dobrovolny was appointed chairman of the committee. The committee members were from the Illinois Basin Coal Mining Manpower Council, the United Mine Workers, Community Colleges, University of Illinois, Southern Illinois University, various state agencies, and others interested in coal manpower needs. Many of these committee members from the mining industry had worked with Dobrovolny and other Department of General Engineering staff members in the development of the mining engineering options in the general engineering curriculum in 1973 and 1974. The first meeting of the committee was on May 29, 1974. The final report with its recommendations was submitted to the governor in December 1975.

The report concluded that several of the community colleges in southern Illinois provide quality and effective programs preparing manpower for the coal industry. The coal companies agreed to cooperate with the community colleges.

The recommendations urged the expansion of several of the programs in proportion to the needs of industry, particularly in the maintenance and repair sectors. Cooperative programs should be established between community colleges.

National Society of Professional Engineers Task Force on Engineering Manpower. At the winter meeting of NSPE in 1974, a resolution was passed for the president of NSPE to appoint a task force to study the supply and demand of engineering manpower. The task force addressed such issues as: Are there too few or too many engineers?, the role of higher education, the role of the engineering technician, the changing mix in the engineering manpower, and the resulting sociological problems. Dobrovolny was appointed to the task force. One of the key statements in the final report of June 1976 is the recognition of engineering manpower teams concept as originally proposed by Dobrovolny in his 1960 paper to the technical design associates meeting.

Impact on Technical Education

During the formative years (1957-77) of the present concept of two-year associate programs in technology, the Engineering Technology Committee had a significant impact on the movement. The activities included developing standards, accreditation criteria, curriculum guides, teacher training programs, consulting to community colleges, legislative involvements, working with professional organizations, working with government agencies, and a host of correspondence with interested parties. The impact of their work is still being felt today.



Chapter 8

Members of the Faculty, 1911–95

Much of the success of the Department of General Engineering and the teaching of engineering graphics from its inception is the result of the quality and the dedication of the faculty. The following vita of the faculty do not include some of the early faculty involved in the supervision and teaching of engineering drawing and descriptive geometry. These individuals are identified in Chapter 1.

William G. Beazley

BS, Mechanical Engr., University of Texas, 1972
MS, Mechanical Engr., University of Texas, 1974
PhD, Mechanical Engr., University of Texas, 1976

William G. Beazley joined the Department of General Engineering in 1976. He taught the upper division courses in the integrated engineering design courses.



His research interests were in rigid body dynamics, transfer matrix dynamic modeling and related areas. He resigned in 1978.

William E. Berkow

BA in Science, University of Stockholm, 1937
MBA, University of Stockholm, 1943
Certificate in Manufacturing Engineering,
Continental Can Company, 1951–53

In addition to his academic training, William E. Berkow had a wide range of experience in industry, including a machinist rating in the Swedish Merchant Marine, a manufacturing Engineer for Continental Can Company for eight years, and his last position before coming to the University of Illinois in 1960 was that of chief



engineer for Chicago Rawhide Company for four years.

He began as an assistant professor and was promoted to associate professor in 1966. During his time with the department, he demonstrated a wide ranging talent. This included making movies on modern machine shop operation, developing material for GE 288 Engineers Economics, and working with faculty in the College of Commerce developing courses in production management and applied industrial psychology.

His untimely death on December 13, 1968, left a large hole in the Department of General Engineering faculty in the area of industrial experience.

Robert W. Bokenkamp

BEd, Industrial Arts, Eastern Illinois State University, 1943

MSc, Industrial and Vocational Education, University of Illinois, 1949

BSc, Architecture, University of Illinois, 1963

Robert W. Bokenkamp joined the Department of General Engineering in September 1960 on an 80% basis as an instructor to teach the basic courses in architectural graphics. He had

been teaching architectural and engineering drawing at Champaign Senior High School from 1946 to 1960, while taking courses in architecture. He had two 8-hour courses remaining for his BS in Architecture which had to be taken in the afternoons for the entire year. The high school would not let him have



a part time contract to do this, so he applied to the department for a position. He also served as lieutenant in the U.S. Navy from 1943–46 in the Pacific theater.

He was promoted to assistant professor in 1964. In 1966, he was called upon to become an assistant dean in the College of Engineering. In 1970, he became an associate professor, as well as an assistant dean until his retirement in the fall of 1986. His work with the students was highly commended by the dean of the College of Engineering.

Vlastimil Patrick Borecky

BS, Faculte des Sciences of Golin, France, 1937

MSc, Engineering, Technological University of Prague, 1939

MA & PhD, Mathematics, University of Toronto, 1960

V. P. Borecky spent 1963–64 as a visiting professor on leave from the University of Toronto. His specialty was in projective geometry and applied mathematics. He gave lectures on these topics while at the university, as well as teaching descriptive geometry. He was unable to continue because of illness and he returned to Canada in June 1964.

Robert P. Borri

BS, Industrial Education, University of Illinois, 1935

MS, Industrial Education, University of Illinois, 1938

EdD, Industrial Education, Penn State College, 1942

Prior to joining the faculty in the fall of 1946, Robert Borri had several years of teaching experience at Indiana State University (1944–45), Penn State University (1942–43), and Tremont Community Schools (1936–41). He also spent three years (1941–43) in industry working at the Seneca shipyards for Chicago Bridge and Iron.

In addition to teaching the basic graphics courses, he also taught GE 220, History of Engineering. Borri was

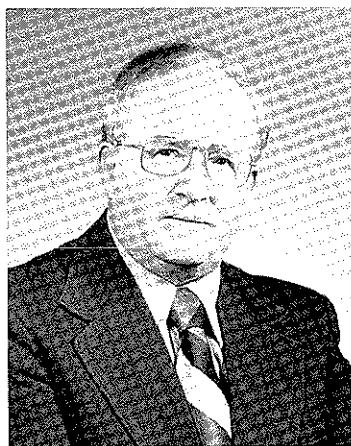

granted a sabbatical leave for the second semester of 1965–66 to go to Italy to further develop his background in the history of engineering. He did a lot of committee work developing teaching models and lecture slides. The series of lecture slides were developed with Robert A. Jewett and were used by over 60 other colleges and high

schools. He was in charge of developing tests for the basic graphics courses.

He was employed as an instructor and rose through the ranks to associate professor in 1955. He retired March 1, 1976. He continued to teach as an emeritus professor on a part-time basis until June 1981.

Scott A. Burns

BS, General Engr., UIUC, 1980
MS, Civil Engr., UIUC, 1982
PhD, Civil Engr., UIUC, 1985

Scott A. Burns was hired as an assistant professor in the Department of General Engineering in January 1985. As an undergraduate senior, he was a lab assistant for one semester in GE 103. He accumulated an outstanding record in his studies, and he graduated with honors in all his degrees, including being named to the University of Illinois Bronze Tablet. While working on his PhD in civil engineering, he was a research and teaching assistant in the Department of Civil Engineering in the areas of structural analysis, reinforced concrete design, structural steel design, stochastic methods in engineering, prestressed concrete design, and structural optimization. He also developed various computer software packages used in several graduate courses. In 1984, he was a systems programmer for the Department of Atmospheric Sciences.

His research work has been outstanding and falls into three broad areas: structural optimization, numerical methods, and scientific visualization. It is in this latter area that he has made significant contributions in applying his computer techniques to attack Sir Isaac Newton's approach for finding approximate solutions to equations that cannot be solved precisely. The challenge has been to determine when Newton's method will turn

chaotic. For his work, he has been recognized in the February 28, 1987, issue of *Science News* as well as in the April 27, 1987, issue of *BusinessWeek*. He is also mentioned in the August 24, 1987, issue



of *Electrical Engineering Times*. From 1991 to 1994, he served as the chair of the American Society of Civil Engineers Technical Committee on Optimal Structural Design, as well as a control member of the Technical Administration Committee on Analysis and Design.

In 1989, he received a the National Science Foundation's prestigious Presidential Young Investigator award. The award is for five years. He has received support for matching funds from Apple Computer, Inc., Digital Equipment Corp., Shell Oil, Inc., and others. All in all, his research support from various sources has exceeded \$1,000,000 between 1985 and 1994. With funds from the various grants, he has established a computer laboratory to carry on his research. He was appointed as a Beckman Associate for the academic year of 1992-93 in the UIUC Center for Advanced Study.

He has been highly respected by his students for his teaching. In 1990, he received the College of Engineering W. L. Everitt Award for Teaching Excellence. He also received the Gamma Epsilon Award for Outstanding Teaching in the Department of General Engineering three times. He has taught GE 103, GE 221, GE 232, GE 241, GE 242, GE 393, GE 497, GE 499, ME 499, and Engr H. 297a. His students in the Project Design Course, GE 242, have won a Silver Award in the Lincoln Arc Welding Competition. He was promoted to associate professor in 1990, as well as being appointed on an indefinite term in the Graduate College. In 1994, he developed a graduate course, GE 493, Engineering Design Optimization.

James V. Carnahan

BS, Engr. Sciences, Purdue University, 1968
MS, Engr. Sciences, Purdue University, 1970
PhD, Engr. Sciences, Purdue University, 1973

Prior to joining the faculty in the Department of General Engineering as an assistant professor in 1983, James Carnahan had extensive experience in industry and private practice. After his BS degree, he was a research engineer with the Naval Avionics Facility in Indianapolis, Indiana. From 1969 to 1973, he was an NDEA fellow and research assistant in the Department of Aeronautics, Astronautics, and Engineering Sciences at Purdue University while he completed his PhD. From 1974 to 1979, he was an associate senior research engineer in the Transportation and Traffic Science Department of General Motors Research Laboratories in Warren, Michigan.

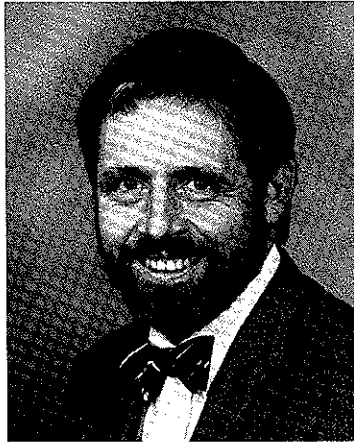

In 1979, he was a principal in Carnahan Engineering and Surveying in Providence, Kentucky, in the practice of civil engineering and land surveying, dealing with client contact, project analysis, field data collecting, final design, report preparation and presentations. The client base was spread over a wide arena of civil engineering practice.

His research interests are in the area of applications of statistical analysis to engineering problems, including the intersections of operations research methodology in aspects of transportation engineering. The focus has been on topics in automobile safety, pedestrian flow, pavement maintenance optimizations, PERT, parameter estimations for the beta distribution. He also worked in the area of uncertainty in decision making evaluating competing methodologies. He has published in refereed journals on many of the above topics.

He has taught GE 103, GE 222, GE 234, GE 242, GE 288, and GE 393. He was involved in the coordination of the departmental laboratory course that includes five modules. He has been awarded a number of teaching

and advising awards over the years. In 1993, he was appointed as the coordinator of the project design activity for the Department of General Engineering. In this capacity, he is responsible for the soliciting the design projects from various industries, and administration of the Project Design Course, GE 242. This normally amounts to over 35 projects per year.

He is highly respected by his students. During the academic year 1992-93, he served as a half-time assistant dean in the College of Engineering. He has also been active in various college and university committees and as an advisor to several student organizations.

Wei Chien Chow

BS, Mechanical Engr., Lester Institute of Technology, China, 1944
MS, Mechanical Engr., University of Wisconsin, 1949
PhD, Mechanical Engr., University of Wisconsin, 1952

Prior to coming to the Department of General Engineering in August 1978



as a lecturer, W. C. Chow had held a number of positions in industry as a design engineer, including working at Bunker Ramo from 1964 to 1978. He was awarded 10 patents and wrote many technical papers. His background suited him particularly well in teaching the Senior Project Design course,

GE 242. He also taught freshman Engineering Graphics, GE 103. He retired May 21, 1991.

William W. Chow

BS, Mechanical Engr., University of Wisconsin, 1971
MS, Mechanical Engr., University of Michigan, 1972
PhD, Mechanical Engr., University of Michigan, 1974

William Chow joined the faculty in the fall of 1975. Prior to coming, he worked for a short time for Kenner Product and as a consultant for General Electric Co. His teaching duties were in the upper division design courses. He was active on the bioengineering committee and published papers in that field. He was adviser for many project designs in GE 242. He left in the summer of 1979 to work for IBM in Tuscon, Arizona.

Thomas F. Conry

BS, Engr. Mechanics, Pennsylvania State University, 1963

MS, Mechanical Engr., University of Wisconsin, 1967

PhD, Mechanical Engr., University of Wisconsin, 1970

Prior to pursuing his graduate studies, Thomas F. Conry worked from 1963–66 as a design engineer with the General Motors Corp. in Milwaukee, Wisconsin. While there, he took graduate courses in the evening program at Marquette University. At the University of Wisconsin from 1966–69, he was a research assistant. He also had an NSF Traineeship 1968–69. From 1969–1971, he was a research engineer for General Motors Corp. In the fall of 1971, he joined the Department of General Engineering as an assistant professor.

He has been very active in the American Society of Mechanical Engineers (ASME), particularly the Design Engineering Division. From 1971–74, he was editor of the newsletter; 1974–75, chair of the Honors and Awards Committee; and 1975–79, a member of the Executive Committee. He served as technical editor of the ASME *Journal of Vibration, Acoustics, Stress and Reliability in Design* from 1985 to 1989 inclusive. He was then appointed to the ASME Board on Communications from 1989–93, and chaired the Publications Committee from 1990–93.

His research interests are in turbo-rotor vibrations, tribology, and failure of rolling element bearing. He has published papers in refereed journals in the areas of gear design for surface durability, design of surfaces for elastic

bodies in contact, automated design of hydrostatic journal bearings, and the automated selection of pumps in hydraulic networks.



He has taught a wide range of courses, including GE 103, GE 199, GE 222, GE 232, GE 241, GE 242, GE 393, as well as advising MS and PhD students in both the Departments of General Engineering and Mechanical and Industrial Engineering. In 1973, he was awarded the Undergraduate Instructor's Award for the summer of 1973 by the UIUC Chancellor's Office. He was one of the key members of the faculty in the development of the master's degree in general engineering.

In the summers of 1974 and 1975, he was selected as a summer faculty fellow in the Case-Lewis Program sponsored by NASA. During the first semester of 1978–79, he was granted a sabbatical leave to do research in the area of traction properties of lubricants under conditions of elastohydrodynamic lubrication at the Cambridge University, Cambridge, England. He was a staff engineer at Sargent & Lundy Engineers during the summers of 1977 and 1979.

He has served as a member of the Urbana Campus Senate and held many important committee positions, including being chair of the Senate Committee on Education Policy and Vice Chair of the Senate Council 1991–93.

In 1986, he was appointed by Dean M.E. Van Valkenburg as co-director of the College of Engineering Manufacturing Program. In 1975, he was promoted to associate professor, in 1981 to full professor, and in 1987, to professor and head of the Department of General Engineering.

Osman Coskunoglu

BS, Civil Engr., Middle East Technical University, Turkey, 1970
MS, Civil Engr., Middle East Technical University, Turkey, 1972
PhD, Operations Research, Georgia Institute of Technology, 1979

While working on his BS degree, Osman Coskunoglu worked summers as an engineering assistant on various construction projects. During his graduate studies, he served as a lab assistant and teaching assistant in the area of ergonomics and management science at Georgia Tech. In the meantime, he also taught at Mercer University and Emory University. His PhD thesis, "A Large Scale Optimization Procedure for the Conjunctive Use of Surface and Ground Water Resources," was recognized as the outstanding dissertation in the Industrial and Systems Engineering Department in 1979-80 at Georgia Tech.



He joined the Department of General Engineering in January 1978 as a lecturer and was made assistant professor in 1979. He was promoted to associate professor in 1985. In 1993, he was accepted for a joint appointment with the Department of Mechanical and Industrial Engineering.

During the 1988-89 academic year, he was on sabbatical leave at the University of Milan, Italy, where the focus of his research was on automation of certain decision-making activities. He synthesized the developments in operations research, artificial intelligence, and cognitive psychology as they pertained to decision making.

His research has been in the area of operations research as applied to various decision models in management and the solution of engineering problems. He has worked on a number of projects with the U.S. Army Construction Engineering Research Laboratory relating to using optimization techniques in the analysis of information for facilities management. More recently, his research focus has shifted to the manufacturing field. General Electric Co. has provided the support for his re-

search on design and operating of a manufacturing system for mixed model and just-in-time production. He has also received support from the Turkish Industrial and Businessmen's Association on assessing and improving the competitiveness of Turkish manufacturing. He has published numerous journal articles and has written a chapter in a book on water resources.

He has taught courses in general engineering as well as industrial engineering, including GE 103, GE 193, GE 288, GE 242, GE 393, GE 493, IE 306, and IE 402. He has also supervised a number of master's as well as doctoral degree students.

Ralph S. Crossman

BS, Civil Engr., Cornell University, 1911
MS, Civil Engr., University of Illinois, 1925

After obtaining his BS degree, Ralph Crossman worked for a number of years in New York City on the design of the subway system and as an engineer for the New York State Highway Department. He began his teaching career at Clemson College in South Carolina from 1918-20 teaching mechanics, surveying and drawing. From 1920-21, he taught at Des Moines University. He joined the (then) Department of General Engineering Drawing in the fall of 1921 where he taught engineering drawing and descriptive geometry. He retired on September 1, 1950. He was highly regarded by his students as being an outstanding teacher.

Robert W. Dalrymple

BS, General Engr., University of Illinois, 1938
MS, Engr., Princeton University, 1948

After obtaining a BS degree, Col. Dalrymple was employed from August 1938 to June 1941 in the production and design of aircraft components for the Goodyear Tire and Rubber Company. In June 1941, he was called to active duty in the U.S. Army as a second lieutenant and rose through the ranks to colonel in May 1962 in the Corps. of Engineers.

He held various command and staff assignments at home and abroad with increasing levels of responsibility commensurate with increasing grade. He served on the faculty of the U.S. Army War College and held assignments at the Pentagon. He retired from the Corps. of Engineers in July 1965.



Dalrymple joined the Department of General Engineering in September 1965 as an assistant professor. He taught GE 101, GE 103, and GE 220. In 1967, he assumed the responsibility of state director of the Junior Engineering Technical Society (JETS). He also was the associate director of the NSF Summer Science Training Program in the summers of 1967 and 1968.

He resigned in September 1968 to take a position with Metropolitan State College in Denver, Colorado.

Wayne J. Davis

BS, Engr. Science, Purdue University, 1970
MS, Engr. Science, Purdue University, 1971
PhD, Engr. Science, Purdue University, 1975

While at Purdue University doing his academic work, Wayne J. Davis had a National Science Foundation traineeship from 1970 to 1973. He also served as a research assistant in the Center for Large Scale Systems and assisted in teaching in the optimal control course. His doctoral dissertation dealt with the decomposition theory of mathematical programming to model decision making in hierarchies of more than two levels. He came to the Department of General Engineering as an assistant professor in May 1975. He rose through the ranks to full professor in 1990.

During the summers of 1978 and 1979, he was selected as a summer faculty research participant at Boeing Computer Services and Argonne National Laboratory, respectively. The projects he worked on had to do with



dispersion of particulates affecting air quality and their impact on the environment. In May 1979, he was approached by Governor James R. Thompson's office to become a consultant to the state of Illinois Emergency Services and Disaster Agency (ESDA) to develop an Illinois plan for radiological accidents. The plan re-

quired the integration of the efforts of ESDA for emergency responses, the Illinois Department of Nuclear Safety for technological assessment of the accident, and the utility for the prevention of further escalation of the accident severity. The plan served as a model for other states as well as the Federal Emergency Agency. The plan included a population evacuation plans in the event of a radiological accident at a nuclear power facility.

In 1976, he was called upon by the College of Engineering to join the Ohio River Basin Energy Study to perform a technological assessment of the air quality impact

arising from the scenarios for siting power plants along the Ohio River corridor. Davis' research quickly demonstrated that the scenarios were unfeasible because the cascading effects arising from having the pollution sources so closely located.

He was also a consultant to the U.S. Army Construction Engineering Research Laboratory working on problems of pavement management and other projects dealing with large-scale systems decision making.

From January through May 1986, he spent a sabbatical leave with the Automated Manufacturing Research Facility at the National Institute of Standards and Technology in Gaithersburg, Maryland. His research centered on extending the current hierarchical framework for the decision-making and control hierarchy associated with automated manufacturing. He also pioneered a new research area, real-time decision making.

His research has been interdisciplinary in focusing on decision making and strategic planning with applications to project management and manufacturing. He has worked with faculty members in the College of Commerce and Business Administration applying his models to planning problems, including budget allocations of a major university. He has received an NSF grant to develop a hierarchical simulation laboratory to test his mathematical models of decision making to formulate an on-line production scheduling algorithm in manufacturing systems.

He has a large number of papers published in refereed journals as well as conference proceedings. He has been called upon to conduct seminars at technical society meetings as well as at meetings with industrial leaders.

During the last eight years, Davis has been focusing his research on the development of advanced manufacturing systems to develop solution for the computer-integrated manufacturing problem. In this effort, he has collaborated with corporations (Motorola and Caterpillar), Department of Defense manufacturing sites (U.S. Army Rock Island Arsenal and Naval Air Warfare Center, Indianapolis) and federal manufacturing research laboratories (Electronics Manufacturing Productivity Facility and Automated Manufacturing Research Facility). He is now transferring the developed technology to the classroom, particularly in the courses GE 495 and MfgE 320.

His teaching has covered a wide range of courses, including GE 199, GE 221, Engr.H. 297, GE 288, GE 242, GE 393, GE 416, GE 495, IE 401, IE 385, IE 416, and MfgE 320. He has advised many master's and PhD students. He holds a joint appointment with the Department of Mechanical and Industrial Engineering.

Jerry S. Dobrovolny

BS, General Engr., University of Illinois, 1943
MS, Mechanical Engr., University of Illinois, 1947

After graduating in 1943, Jerry Dobrovolny went to the Army Officers Candidate School and completed the program. Three days prior to being commissioned a second lieutenant, he was taken ill and spent the next nine months in the Walter Reed Medical Center in Washington, DC.

Upon his discharge in December 1944, he contacted C. H. Springer who had been his academic adviser to let him know what had happened. He was then contacted by Associate Dean H. H. Jordan, who asked him to come and teach engineering drawing to 17 year olds in the three-month Army Specialist Training Reserve Program (ASTRP). After this, he taught one-third time and worked two-thirds time on a navy research project investigating the notch sensitivity of wide steel ship plates that were used to build liberty ships. This was in the Department of Civil Engineering.

In the fall of 1948, he became a full-time instructor in the Department of General Engineering Drawing. He rose through the ranks to full professor and head of the Department of General Engineering in September 1959. He retired on December 1, 1987.

Between 1948 and 1959 he worked summers in various engineering positions such as four summers as a special research assistant for the Illinois State Geological Survey; five summers as a research assistant and research associate professor in the Department of Civil Engineering, working on various research



projects in soil mechanics; and three summers as a design engineer and a traffic engineer for the Illinois State Highway Department in Paris, Illinois.

In his academic work in 1950 he developed a course (GE 205) for geology students in the use of descriptive geometry methods in solving structural geology problems. In 1953, he was selected to teach a course developed by a College of Engineering committee called GE 250, the Philosophy and Methods of Engineering. In 1953, he also assumed the teaching responsibilities for GE 220, History of Engineering.

Among his other interests was the need for engineering technicians. A detailed discussion of his involvement in technical education is presented in Chapter 7. It involved the College of Engineering, the College of Education, the state of Illinois, and various agencies of the federal government.

He was called on frequently as a consultant and presented many papers on the subject of engineering technology. He was active in a wide range of technical, honorary, and professional societies, including Sigma Xi, American Association for the Advancement of Science (fellow), Newcomer Society, Illinois Society of Professional Engineers (president), National Society of Professional Engineers, listed in several Who's Who publications, American Society for Engineering Education, American Technical Education Association (president), American Society of Civil Engineers, and others. In all of these, he has held important committee chairs and assignments.

At the university level, Dobrovolny chaired a number of Senate committees, including the Military Education Council for seven years. He was elected to serve on the NROTC Association of Schools and Colleges Executive Committee (1986-92) which advised the admiral overseeing the NROTC program nationally.

George R. Eadie

BS, Mining Engr., University of Illinois, 1949
MS, Mining Engr., University of Illinois, 1956
Engr. of Mines, University of Illinois, 1957

Upon graduation, George R. Eadie was employed in management positions by various employers in the coal industry. In 1954, he returned to the University of Illinois to pursue his graduate degree and was employed by the Department of Mining and Metallurgical Engineering as a research assistant. In 1956, he was appointed as an assistant professor and taught undergraduate courses.

From February 1963 to March 1968, he was employed by the Freeman Coal Mining Corp. and later as an associate editor of the *Coal Mining and Processing Magazine*. In 1968, he came to the Illinois State Geological Survey as an administrative engineer and head of four subdivisions of the mineral research group.

In September 1966, the University of Illinois discontinued mining engineering. As a result, the students in the program were encouraged to enroll in the Geo-Science Option in General Engineering. When Allan Krug who had been advising the students in the Geo-Sciences Option resigned, Eadie was brought on board in March 1971 on a zero-time appointment basis.



In 1974, he worked closely with Jerry S. Dobrovolny, who was chair of the Governor's Committee on Coal Manpower. His background in the coal industry was invaluable in articulating a meaningful report on the future of coal manpower in Illinois.

He retired in 1976.

Edward D. Ebert

BS, Civil Engr., University of Illinois, 1939
MS, Civil Engr., University of Illinois, 1949

Upon graduation, Edward Ebert joined the Bethlehem Steel Co. as a civil engineer doing design and fabricating work. He left in 1945 for military service in the Corps of Engineers at Fort Belvoir, Virginia, and was there until the fall of 1946 when he joined the faculty as an instructor. He was promoted to professor in 1964, and retired in May 1978.

In addition to teaching the graphics courses in General Engineering, he also taught surveying in the summer camps conducted by the Department of Civil Engineering. In the early 1960s, he assumed the responsibilities as chief adviser for general engineering students.



Carl A. Edstrom

BS, Architectural Engr., University of Illinois, 1943
MS, Architecture, University of Illinois, 1967
EdD, Education, University of Illinois, 1972

Carl A. Edstrom joined the faculty in February 1967 as a teaching assistant while he worked on his doctorate in education, which he obtained in May 1972. Prior to coming to the University of Illinois, he was employed by Boeing Aircraft Co. in Seattle, Washington, from February 1943 to 1950. After that, he was a missionary in the Republic of the Congo, where he was in charge of the building progress of a museum. He taught the freshman engineering graphics course, GE 103. After leaving the University of Illinois in 1972, he returned to Africa to teach.

George W. Eggeman

BS, Mechanical Engr., Missouri School of Mines, 1962
MS, Mechanical Engr., University of Illinois, 1968
PhD, Mechanical Engr., University of Illinois, 1972

George Eggeman joined the Department of General Engineering as a teaching assistant in February 1967 while he was working on his PhD in mechanical engineering which he obtained in 1972. In the fall of 1967, he became an instructor. After he obtained his PhD, he left the university in 1972, since at the time the College of Engineering had a policy to not hire its own PhDs. George was an outstanding teacher, having won the 1972 College of Engineering Stanley H. Pierce award



for his contributions to improving student-faculty relations. His teaching activities included teaching the freshman engineering graphics courses as well as GE 221 and GE 231, the introductory design courses.

Charles F. Gebhardt

BS, Mechanical Engr., University of Illinois, 1928
MS, Theoretical & Applied Mechanics, University of Illinois, 1969

Charles F. Gebhardt served a unique role in the Department of General Engineering. He came on board as an engineering design consultant in February 1968, and served in that role until May 1983. He was a full-time employee of Caterpillar Tractor Co. in Decatur, Illinois, where he was a project design engineer. He began when the department had the Ford Foundation grant to develop the interdisciplinary engineering design courses and then stayed on until his retirement from Caterpillar. He was highly regarded by his students in Senior Project Design, GE 242.



David E. Goldberg

BS, Civil Engr., University of Michigan, 1975
MS, Civil Engr., University of Michigan, 1976
PhD, Civil Engr., University of Michigan, 1983

While at the University of Michigan, David E. Goldberg served as a research and teaching assistant with support from various fellowships. He was also in the U.S. Coast Guard Reserve from 1973 to 1979. From 1976 to 1980, he was a project engineer for Stoner Associates in Carlisle, Pennsylvania, after which he returned to complete his PhD.



From 1984 to 1987, he was an assistant professor, from 1987 to 1990, an Associate Professor at the University of Alabama, teaching graduate and undergraduate courses in the Department of Engineering Mechanics. While there, he was awarded the prestigious NSF Presidential Young Investigator award from 1985-90. In 1986, he was the Prater Exchange Professor to the National Taiwan University. In 1988, he was a visiting scientist at the Rowland Institute in Cam-

bridge, Massachusetts, for two months. In 1990, he was a distinguished visiting professor at ITESM in Monterrey, Mexico.

He joined the Department of General Engineering as an associate professor in the fall of 1990 and was promoted to full professor in 1993. In 1993-94, he served as a half-time assistant dean in the College of Engineering.

His research interests are in genetic algorithms—search procedures based on the mechanics of natural selection and natural genetics. The work has important ramifications for the understanding of all innovative systems, from brains to economics to ecologies. The work also has important implications for the computational-mathematical underpinnings of engineering design.

He has published widely in refereed journals and conference proceedings. He has authored and co-authored several books on genetic algorithms, as well as contributing chapters in other books. He has written a large number of computer codes used in a range of industrial applications. He has also had support for his research from various industries and governmental agencies.

He has taught GE 103, GE 221, GE 242, GE 291, and GE 393. He has been an adviser to graduate students at both the master's and PhD levels. He also has served as an adviser to student organizations.

W. Brenton Hall

BASc, Civil Engr., University of Waterloo, 1975
PhD, Civil Engr., University of Waterloo, 1979

During W. Brent Hall's undergraduate studies, he was enrolled in a cooperative education program whereby he worked for the city of Waterloo Engineering Department. This involved surveying, design of roadways, sanitary and storm sewers, water mains and many other aspects of civil engineering. As an undergraduate research assistant, he also worked on cold-formed steel design problems for the development of the Canadian Design Standard 5136. The example problems later became part of a design manual.

From 1975 to 1979, he had appointments as a research and teaching assistant while pursuing his PhD. His research was in the area of optimal structural standardization, which was applied to the design of cold-formed steel structural members. He also did research on reliability verification using load tests. He came to the Department of General

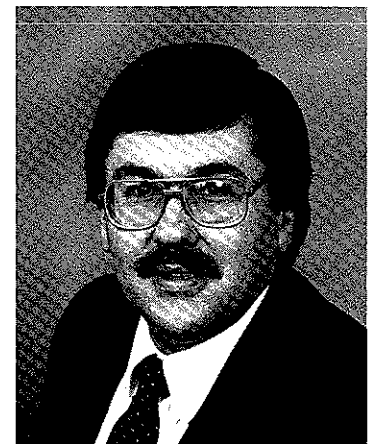

Engineering in the fall of 1979 as a visiting assistant professor and rose through the ranks to associate professor in 1987.

He has taught GE 103, GE 221, GE 234, GE 241, GE 242, GE 288, GE 334, and GE 393. GE 334, Reliability Engineering, was developed by Hall. The course has been widely accepted by graduate students in various fields as well as being taught using videotape and the Electronic Blackboard to students throughout Illinois. He has incorporated the use of computer-aided design techniques in many of his courses. He is highly regarded by his students and has been the faculty adviser to the Illinois Society of General Engineers and Gamma Epsilon, the general engineering student honor society.

His research interests include reliability methods in structural design, reliability models of load testing, structural standardization and optimization, structural mechanics, and cold-formed steel design. His current research activities include probabilistic models for design by testing and reliability assessment of controlled structural systems.

He has been active in technical societies, serving on various committees dealing with the design integrity of cold formed structural members and structural reliability. He has published in a variety of refereed journals.

During the academic year 1989-90, he was granted a sabbatical leave to study and do research on advanced methods for reliability-based design, testing and assessment of structural systems and decision making under test uncertainty. He has had a number of grants from various funding sources to further his research.

Stanley G. Hall

BS, Mechanical Engr., University of Maine, 1923
MS, Theoretical & Applied Mechanics, University of Illinois, 1930

Prior to coming to the University of Illinois, Stanley G. Hall taught at the University of Maine for two years. He rose through the ranks from instructor in 1925 to full

professor in 1949. He retired in June of 1966 after 41 years teaching engineering graphics. He also taught mechanics in the Department of Theoretical and Applied Mechanics. He co-authored a number of workbooks in engineering graphics and developed and conducted an in-service training program for new teachers in engineering



graphics. He died on October 14, 1976.

Bruce M. Hannon

BS, Civil Engr., University of Illinois, 1956
MS, Theoretical & Applied Mechanics, University of Illinois, 1965
PhD, Theoretical & Applied Mechanics, University of Illinois, 1970

Prior to coming to the Department of General Engineering in the fall of 1965, Bruce Hannon was employed as a structural design engineer from 1956 with the U.S. Industrial Chemical Co. He began as an instructor while completing his PhD in 1970, at which time he was promoted to assistant professor.

From March 1970 to November 1972 he was half-time with the Department of Computer Science. The second semester of 1972-73, he was 10% with General Engineering and 90% with the Center for Advanced Computation. In the fall of 1973, he left the Department of General Engineering to go full

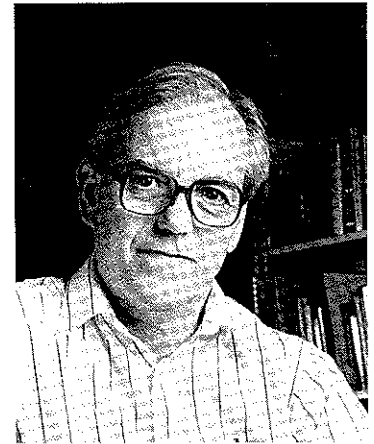

time with the Center for Advanced Computation.

Hannon was active in teaching in the design sequence, namely GE 232 and the project design course, GE 242. In 1969-70 in GE 242, he organized a student group that called itself the Concerned Engineers for Restoration of the Boneyard (CERB). The students took essentially two-block sections of the Boneyard Creek and designed water retention basins and other flood control implementations. The students organized clean-up activities of the Boneyard, including the identification of pollution sources.

After leaving the Department of General Engineering, he was promoted to the rank of associate professor in August of 1974 as a member of the Graduate College. At the writing of this document, he is still with the university in the Department of Geography.

William W. Happ

BS, Engr. Physics, M. Gill University, 1945
MS, Nuclear Physics, Massachusetts Institute of
Technology, 1949
PhD, Theoretical Physics, Boston University, 1949

William Happ had an outstanding research background prior to coming to the Department of General Engineering for the academic year of 1970-71. He was a role model for the young faculty while he was here. He went from here to assume the deanship of the College of Engineering at Sacramento State.

Thomas C. Hartley

BS, Mechanical Engr., University of Illinois, 1944
AM, Psychology, University of Illinois, 1948

Thomas C. Hartley served in the U.S. Navy from April 4, 1944, to October 21, 1946, after which he went



for his MA in psychology in 1948. He then worked in industry prior to being appointed as an assistant in the fall of 1949. He became an associate professor in 1960. He was instrumental in developing the College of Engineering Teacher Evaluation Form, years before the university-wide program was established. He worked

closely with the campus Office of Instructional Resources in developing university-wide programs for teacher evaluations. He also chaired the college honors committee. He retired in 1987 and died on February 19, 1993.

Ralph J. Henneman

BS, Electrical Engr., University of Illinois, 1949

Ralph Henneman served as half-time lecturer from



the fall of 1969 until May 1973. From 1950 to 1960, he was employed as an electrical engineer in the University of Illinois Physical Plant Department and Architects Office. Since 1960 he has been a co-owner of mechanical and electrical consulting engineering firm, Henneman-Raufeisen & Associates, Champaign, Illinois. He

served as a design engineer consultant for Senior Project Design, GE 242.

Uffe Hindhede

BA, Engr., Vjile College, Denmark, 1943
MS, Mechanical Engr., Technical University of
Denmark, 1950
MS, Mechanical Engr., University of Illinois, 1964

Uffe Hindhede joined the Department of General Engineering as an instructor in September 1961. His prior experience over a 12-year period was in heavy machinery design with various companies. After one year, he decided to pursue full-time graduate studies. In February 1966, when his research funding in the Department of Mechanical and Industrial Engineering ran out, he returned to General Engineering on a part-time basis until August 31, 1969, when he resigned to take a position with Black Hawk College in Moline, Illinois. While here, he taught freshman engineering graphics and was a valuable member of the staff teaching the senior project design course.

John P. Hipskind

BS, Mechanical Engr., University of Notre Dame,
1952
MS, Industrial Engr., University of Illinois, 1959

After graduation from Notre Dame, John Hipskind was employed by the General Electric Co. as a methods and standards engineer, performing time studies and rate setting. He also worked one summer for U.S. Steel. He joined the Department of General Engineering in September 1954 as an instructor. In 1959, when he obtained his MS in industrial engineering, he was promoted to assistant professor.

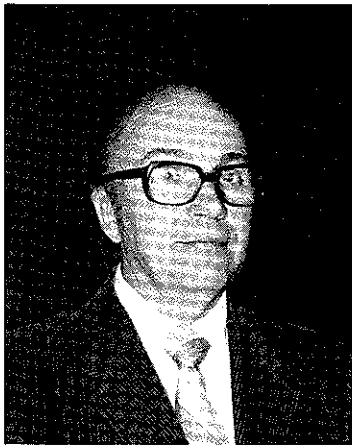

His teaching experience covered a wide range of courses including GE 101, GE 102, GE 103, GE 104, GE 105, GE 106, GE 112, GE 210, GE 212, GE 220, GE 288, GE 313, and GE 330. He also conducted various statistical surveys and co-authored a number of graphics workbooks. He was very active in teaching extension

courses of the practicing engineers preparing to take the state of Illinois Professional Engineer's examinations. He was noted for his outstanding flexibility in teaching different courses. He retired in August 1989.

Randolph P. Hoelscher

BS, Civil Engr., Purdue University, 1912
MS, Civil Engr., University of Illinois, 1927
CE, Purdue University, 1929

Prior to coming to the University of Illinois in 1918, Randolph P. Hoelscher was a structural engineer from 1912-16, and from 1916-18, he was an instructor of physics at Baldwin-Wallace College. In 1918, he was appointed an instructor in the Department of General Engineering Drawing and rose through the ranks to a professorship in 1931. During his career he was a prolific textbook co-author of engineering drawing texts. He was also active in the American Standards Association and the American Society for Engineering Education. From 1946 to 1949 he served as associate dean of engineering sciences at the Navy Pier campus of the University of Illinois in Chicago. In September 1949, he returned to the Urbana campus to become head of the Department of General Engineering Drawing, succeeding Harvey H. Jordan. In September 1953 the department



name was changed to the Department of General Engineering. Associate Dean Jordan retired that year and the new associate dean, Stanley Holt Pierce, recommended the transfer of the administration of the general engineering curriculum from the Associate Dean's Office to the new department, together with the drawing courses and such other courses as engineering law, history of engineering, and technical writing.

Hoelscher was the first head of the Department of General Engineering until his retirement in September 1959.

Bruce R. Holecek

BS, General Engr., University of Illinois, 1971
MBA, University of Illinois, 1974

Bruce Holecek was a teaching assistant starting in the fall of 1971 while he was taking courses toward an



MBA His business acumen is worthy of note in this document. While working on his BS in general engineering, he and his wife operated a mail-order business out of their home, selling radio control model airplanes and parts. Upon obtaining his BS degree, he organized Tower Hobbies, Inc. He developed and implemented

a unique inventory control and order processing program on an IBM Systems 3 Model 6 computer. The program, hardware, and software requirements were so novel that IBM prepared a descriptive booklet to be circulated to its marketing managers.

He left the department in December 1975 to devote full time as president of Tower Hobbies, which developed into a \$5 million operation in a few short years. He also was editor and publisher of *Tower Talk*, a 24-page trade magazine with a circulation of over 20,000.

Rodney D. Hugelman

BS, Mechanical Engr. (Aero), Oregon State University, 1956

MS, Mechanical Engr. (Aero), Oregon State University, 1959

PhD, Engineering, Oklahoma State University, 1964

Rodney D. Hugelman came to the Department of General Engineering in August 1976 with a highly diversified engineering background. After graduating in 1956, he was employed as a design engineer in the aerospace industry and then returned to Oregon State as a Shell Oil Co. fellow in 1957 to work on his master's degree. While there, he taught engineering graphics for a year.

In December 1958, he was called to active duty as a lieutenant in the U.S. Air Force where he graduated from the USAF Management School. The air force then sent him to Oklahoma State University to obtain his PhD in 1964. His research topic was magneto-hydrodynamics. He then returned to the Aerospace Research Labs in Dayton, Ohio, as a captain assigned as an engineering science officer.

In 1968, he left the air force and joined the faculty as an associate professor and director of the Aerospace/Mechanics Division at North Dakota State University in Fargo. While there, his students earned a large number of firsts in the AIAA paper presentations as well as three Bendix Awards for their clever presentations.

In 1972, he left North Dakota State University for industry in Rockford, Illinois. He was an executive consultant for research and product development with the General Progress Corp. While there, he designed and had patented a low-cost fluidic robot.

Wanting to resume teaching, Hugelman came to the Department of General Engineering in the fall of 1976 as an assistant professor. He became the leader of Senior Project Design, GE 242. His broad knowledge of the practicing engineering design field opened many doors to companies that would participate as project sponsors for the student teams in GE 242. In the fall of 1982, he became an adjunct professor until his retirement in Au-

gust 1992. His impact upon the design program was profound. The large number of student awards from the Lincoln Arc Welding Design Competitions is further testament to his effectiveness.

Robert A. Jewett

BS, Architectural Engr., University of Nebraska, 1932

MS, Civil Engr., Georgia Institute of Technology, 1934

Robert A. Jewett came to the Department of General Engineering in the fall of 1953 as an instructor. He rose



through the ranks to become a professor in the fall of 1968. Prior to coming to the university, he had taught engineering drawing at Florida Southern College for nine years and algebra and physics in high school in Bartow, Florida, for four years. In 1941, he worked as a cartographer for the U.S. Army Corps of Engineers.

He was employed as a structural design engineer for the Hoppers Co. and later the Dravo Corp. While at Dravo, he taught a draftsman apprentice program covering engineering graphics, math, mechanics, strength of materials, piping, etc. He was at Dravo for eight and one-half years just prior to coming to the University of Illinois.

He taught engineering graphics, history of engineering, and the project design course. He was extremely well liked by the students. He was the Jaycees "Layman of the Year" in 1972, and received the ISPE "Illinois Award" in May 1972. He was the faculty adviser for the student branch of ISPE.

He and Robert P. Borri developed a series of slides in engineering graphics that were widely used by well over 60 other universities, junior colleges, and high schools.

In the five-year and ten-year follow-up studies conducted by the College of Engineering of its graduates, Jewett was always listed for his influence in their technical, professional, or personal development.

He retired in May 1975 and then came back for a year on a part-time basis before he moved to Florida.

Nicholas M. Karayanakis

BS, Mechanical Engr., Athens Technical Institute,
Greece, 1966
MS, Science Teaching, Governor's State University,
1974

Nicholas Karayanakis joined the Department of General Engineering as a graduate teaching assistant in 1976. He was promoted to instructor in 1978. He was on a part-time appointment while working toward a PhD in technical education. While in the department he taught engineering graphics.

Prior to coming to the department, he spent considerable time teaching in various flight programs training pilots. He left the department in May 1980.

Paul E. Karlstrom

BS, Accountancy, University of Illinois, 1943
LLB, University of Illinois, 1950

Paul Karlstrom served three years in the U.S. Army from 1943 to 1946. After which he enrolled in Law School. In 1951, he went into the private practice of law. He taught business law on a part-time basis from 1952-61 at the Illinois Commercial College in Champaign, Illinois.

In the fall of 1963, he joined the Department of General Engineering on a 60% basis teaching GE 292, Engineering Law. He retired as a lecturer in August 1990.



Yong Se Kim

BS, Mechanical Engr., Seoul National University,
South Korea, 1983
MS, Mechanical Engr., Stanford University, 1985
PhD, Mechanical Engr., Stanford University, 1990

While pursuing his graduate studies, Yong Se Kim was a research and teaching assistant at Stanford University. He worked in the area of geometric modeling and mathematical methods in mechanical engineering. He was a software engineer at Fujitsu America, Inc., prior to joining the faculty in the Department of General Engineering as an assistant professor in 1990. In 1992, he was given a zero time appointment in the Department of Mechanical and Industrial Engineering.

His teaching has been the area of geometric modeling including GE 103, GE 242, GE 393, GE 493, and GE 499. Under GE 493, he has developed a new course, Solid Modeling and CAD/CAM Applications. He is developing another new course, Computer-Aided Design Systems, GE 393. He also has been active in advising graduate students.

His research interest is in the area of computer-aided design and manufacturing, solid modeling, and geometric and visual reasoning. His research goals are (1) to provide computer-based aid to improve human design



and visual reasoning capabilities and (2) to enable automated geometric reasoning for computer-integrated design and manufacturing. He is directing the Solid Modeling Laboratory, where an interdisciplinary team of students is conducting research on integrated product engineering. In fall 1995, 11 students (4 GE, 3 ME, 4

CS) were working under his supervision in the laboratory. His research projects in CAD/CAM integration using integrated project modeling and process planning are being sponsored by NSF and University of Illinois Manufacturing Research Center. He also directs the NSF Leadership in Laboratory Development project for visual reasoning instructional software development. He initiated, as project director, the NSF Combined Research-Curriculum Development project for integrated engineering and industrial design in collaboration with colleagues in the School of Art and Design and the Department of Mechanical and Industrial Engineering.

He is an executive committee member of ASME Computers in Engineering Division, and he has served as the chairman of Artificial Intelligence and Feature-Based Design and Manufacturing Technical area of ASME Computers in Engineering conferences since 1994.

Raymond R. Kimpel

BS, Ceramic Engr., University of Illinois, 1950
LLB, University of Illinois, 1953

Raymond Kimpel was employed as an instructor on a 20 percent basis from September 1964 to May 1966, teaching a section of GE 282, Patent Law, while Harrison Streeter was on leave obtaining his PhD in industrial engineering. Kimpel was a practicing attorney in Urbana, Illinois.

Howard W. Knobel

BS, Electrical Engr., University of Illinois, 1950

Howard W. Knobel began his career as a research associate in the Control Systems Laboratories in 1950, and worked there until 1957 at which time he transferred to the Coordinated Science Laboratory as a research associate professor and was promoted to research professor in 1964. He worked on various electronics instrumentation projects, including the development of the "electro-



static gyroscope," a high-precision inertial navigation instrument now used in aircraft and nautical guidance systems.

In 1964, he had a joint appointment with the Department of Aeronautical and Astronautical Engineering and the Coordinated Science Laboratory. His research group developed a radio propagation system using sounding rockets to measure upper atmosphere electron density and collision frequency. His work in control systems brought him in contact with a GE 242, Project Design, in applying fluidic devices in developing a highway vehicle system for the severely handicapped individuals.

In 1975, he joined the Department of General Engineering where he was a key member of the project design faculty as well as teaching GE 103, GE 104, GE 193, GE 222, GE 242, and GE 393. He retired in May 1979, but continued as a professor emeritus on a part-time basis until May 1989, teaching in the project design course.

Alan D. Krug

BS, Mining Engr., University of Illinois, 1964
MS, Economics, University of Illinois, 1970

At the time Alan D. Krug joined the Department of General Engineering as a teaching assistant, the general engineering curriculum had a secondary field of concentration in mining and geological engineering. As a graduate student, he was majoring in operations research. In the fall of 1967, he was named an instructor and continued to work on his graduate program. From September 1970 until he resigned in May 1972, he was on leave of absence, continuing his PhD program at the University of Minnesota.

While in the Department of General Engineering, he taught GE 101, GE 242, GE 288, GE 293, and GE 393. His career plans were to apply systems engineering to the mining industry.

Edward N. Kuznetsov

BS, Civil Engr., Moscow Civil Engineering Institute, USSR, 1956
PhD, Civil Engr., Moscow Civil Engineering Institute, USSR, 1959
Dr.Sci., Central Research Institute of Structures, USSR, 1967

Edward N. Kuznetsov joined the Department of General Engineering as a full professor in the fall of 1980.



His accomplishments prior to joining the department were outstanding. In the USSR, he was acknowledged to be one of the top 15 scientists in his discipline. In 1974, he was able to immigrate to Israel and was a senior research associate at the Institute of Technology. In 1976, he joined the staff as a principal scientist in the Mechanics and Structures Department at the Battelle Memorial Institute in Columbus, Ohio.

His letters of recommendation for appointment all spoke to his outstanding ability as a research scientist. In the transmittal of his appointment papers to then vice chancellor of academic affairs, E. L. Goldwasser, Dean D.C. Drucker wrote:

"His reputation was soundly established in the U.S.S.R. before my first visit in 1964 We would be getting a great catch if we attract him here ... at Battelle, he has done some very innovative designs of the type that fit very well in General Engineering."

Kuznetsov's research interests and activities cover a spectrum of problems in structural design. He has developed a finite-element method for the analysis of arbitrary shells of revolutions under axisymmetric load and temperature. Other areas of interest are in tensile structures addressing problems of optimizations in design. He has published widely in both Soviet journals, as well as refereed journals in the United States. He has been issued several patents. His research has been supported by NSF, U.S. Navy, NASA/Cal Tech, U.S. Army CERL, and U.S. Army Satellite Communication Agency.

During his sabbatical leave in the fall semester of 1990-91, he completed writing a book, *Underconstrained Structural Systems*. One of the applied mechanics reviewers writes: "... the author lays foundations of a new chapter of engineering mechanics. Perhaps someday it will be considered a classic in its own right."

In his teaching, he has taught GE 221, GE 232, GE 241, GE 242, GE 393, GE 493, as well as advising MS and PhD students in General Engineering and in addition to those enrolled in other departments. He is highly respected by his students and was awarded the department's Gamma Epsilon Teaching Excellence Award in 1984 and 1994.

Bernt O. Larson

BS, Civil Engr., University of Illinois, 1938
MS, Civil Engr., University of Illinois, 1949
CE (Professional), University of Illinois, 1950

Upon graduation in February 1938, Bernt Larson joined the Department of General Engineering Drawing as a teaching assistant. The next fall he became an instructor and rose through the ranks to professor in 1953. From February 1942 until November 1, 1945, he was on

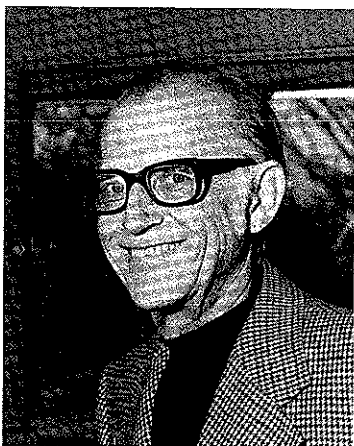

military leave without pay. While in the U.S. Army Corps of Engineers, he served for two years as director of the Surveying School at Ft. Belvoir, Virginia, before going on to serve in the China-Burma Theater and reached the rank of major. Upon release from the U.S. Army, he continued on in the U.S. Army Reserves in a research and development unit as a lieutenant colonel.

Upon returning to the department, he began his teaching duties primarily in GE 102, Descriptive Geometry. He co-authored a number of workbooks for the course. In the summers, he continued his research in

hydrology with the state of Illinois Water Survey and published a number of papers in the field. He eventually became chair of the GE 242, Project Design course. He was also associate director of the Ford Foundation grant to assist in the development of the design program in the late 1960s.

Among his other activities, he was associate director for 17 years of the NSF six-week Summer Science Training Program for high-ability secondary students. He also was involved with the two-week summer JETS program for secondary students. He was a consultant to the U.S. State Department AID Program going to Brazil and the Philippines to assist in the industrial development in those countries. He died in December 1974.

In recognition of his outstanding contributions to the development of integrated engineering design education, the Bernt O. Larson Project Design Award was established in 1975. The award is presented annually to the senior student project design team judged by the faculty as producing the best engineering design during a particular year.

Samuel Lomask

BS, Mechanical Engr., New York University, 1948

After graduation, Samuel Lomask worked for various industrial companies such as Allis-Chalmers, Bethlehem Steel, and Westinghouse. He joined the Department of General Engineering in September 1955. He taught the architectural projection courses, GE 107 and 108. He also was taking courses in the School of Architecture. He resigned in September 1961.

LeGrand L. Malany

BS, Engr. Physics, University of Illinois, 1964
JD, University of Illinois, 1970

"Lee" Malany, as he was known to his colleagues, had an interesting tour of duty with the Department of General Engineering. He started as a teaching assistant in the Department of Physics in the fall of 1964 and transferred to General Engineering in 1965. In 1967, he became an instructor until his resignation in May 1971. All of this time he was on a part-time appointment while pursuing his studies in the College of Law.

During his short stay with the Department of General Engineering, he had a number of duties. In the summer of 1967, he worked with the Office of Instructional Resources dealing with the construction and analysis of objective type test exams in GE 103. He continued that work during the 1967-68 academic year.

In the academic year 1968-69, he was the chief investigator of a grant from the Illinois Secretary of State in developing an operational manual for the licensing of motorcycle drivers. He was chairman of the motorcycle bicycle subcommittee; a member of the Traffic-Transportation Committee; member of Motorcycle Accident Review Committee; and taught a defensive driving course through the university Safety Coordinator's Office.

He did teach GE 103 when he first began with the department. Upon his resignation, he went with the Office of the Illinois Secretary of State as the director of planning of the Driver's License Division. Subsequently, he was with the National Highway Traffic Safety Administration in Washington, DC, before he returned to Springfield, Illinois, to work with the Comptroller General's Office.

Gordon E. Martin

BS, Mechanical Engr., University of Illinois, 1948
MS, Civil Engr., University of Illinois, 1949
PhD, Civil Engr., University of Illinois, 1961

Prior to joining the Department of General Engineering in February 1953, Gordon E. Martin was an assistant and an instructor in the Department of Mechanical Engineering from 1949 to 1953, where he taught ME 201, ME 202, ME 205, ME 254, ME 263, and ME 264. His hallmark in the department was teaching and working with the students. His teaching included the following courses: GE 101, GE 102, GE 103, GE 104, GE 106, GE 112,



GE 221, GE 231, GE 241, GE 242, GE 291, and GE 360. His research with John E. Pearson was in the field of meteorology, which resulted in a number of publications. He also co-authored workbooks in engineering graphics.

For 17 summers, he was an associate director of the NSF six-week sponsored Summer Science Training Program for high-ability secondary students in which he taught the mathematics segment of the program. For about 27 years, he also taught the mathematics portion of the two-week summer JETS program and the two-week MITE program.

From June 1944 to October 1946, he served as an Air Weather Officer for the U.S. Air Force as a first lieutenant. To prepare for this assignment, he spent from March 1943 to June 1944 at MIT taking a program in meteorology.

He served on many college committees, including Honors Program, Placement Committee, and Committee on the Use of Computers in Educational Programs, and a host of committees in the department.

He retired in August of 1989.

Waldo D. Martin

BS, Agricultural Engr., Purdue University, 1955
MS, Mechanical Engr., University of Illinois, 1962
EdD, Vocational Education, University of Illinois, 1970

Waldo Martin, known as Dean, was a design engineer for John Deere & Co. from 1955 to 1961. He was on military leave in the U.S. Navy in 1956 and 1957. In the fall of 1961, he joined the Department of General Engineering as a teaching assistant. After he obtained his master's degree in 1962, he took a teaching position at



the College of Engineering at the University of Colorado from September 1962 to September 1965. From there, he went to Tri-State College in Angola, Indiana, as an assistant professor for the 1965–66 school year.

In 1966, he decided to fashion his career in the direction of vocational and technical education. He was admitted to the doctoral program in vocational education at the University of Illinois in the fall of 1966, and was employed as an instructor in the Department of General Engineering. Upon completion of his doctoral degree, he took a position as head of the Department of Industrial Education and Technology at Eastern Washington State College in Cheney, Washington.

Edwin C. McClintock, Jr.

BA, History, University of Virginia, 1936

Prior to coming to the University of Illinois, Edwin McClintock taught speech and English from 1936 to 1955. He was originally hired in 1955 to assume the duties previously done by Lisle A. Rose, whose untimely death occurred just as the headquarters of the American Society for Engineering Education were being moved to the Urbana campus. After five years as director of engineering information and publications, he was transferred to the Department of General Engineering in September 1961 as a professor whose duties included teaching GE 304, Engineering Report Writing. He also worked with students in mechanical engineering assisting them in the preparation of their various engineering reports.

McClintock retired in May 1976 and continued as a part-time professor emeritus until May 1979. He died on February 7, 1982.

Juraj V. Medanic

BS, Electrical Engr., University of Belgrade, Yugoslavia, 1964

MS, Controls, University of Belgrade, 1966

PhD, Systems Engr., University of Belgrade, 1972

After receiving his bachelor's degree, Juraj V. Medanic was a research associate at the M. Pupin Institute in Belgrade, Yugoslavia, from 1964–66. During the period of 1967–69, he was a visiting research associate with the Coordinated Science Laboratory at the University of Illinois. From 1969 to 1976, he was a senior research associate and group leader at the M. Pupin Institute. During this period, he also taught courses in opti-

mal control theory, differential games, and optimization methods. He spent 1971 in military service.

From 1976–79, he was a visiting research associate professor in the Coordinated Science Laboratory doing research in large-scale dynamic systems. In 1979, he spent a year with the Technisches Hoogeschoole-Twente, Holland, after which he returned to the University of Belgrade and the M. Pipan Institute from 1980–83, doing research in systems analysis applications and teaching a course in large-scale systems.

In 1983, he returned to the University of Illinois on a joint appointment as a visiting professor of general engineering and a visiting research professor of the coordinated science laboratory. In 1986, he was made a professor, continuing his joint appointment listed above, as well as a professor of electrical and computer engineering. He has been a prolific author of papers in refereed journals and advised many graduate students. From 1985–90, he was also a member of the Beckman Institute.

He has had financial support for his many research activities, one of which was a grant from Wright-Patterson Air Force Base in 1988 for \$64,000 for investigating the systematic low-order controller design for disturbance rejection with plant uncertainty. The results of this research were applied to the navy's Tomahawk Missile that was used so successfully during Operation Desert Storm.

His teaching has included GE 242, GE 393, GE 491, GE 493, GE 499, ECE 380, ECE 497, and ECE 499. His research area continues to be in large-scale systems design, using various optimization techniques. In addition to the large number of technical papers, he also has contributed chapters in several books.



L. Daniel Metz

BS, Mechanical Engr., University of Cincinnati, 1965

MS, Mechanical Engr., University of Detroit, 1967
PhD, Mechanical Engr., Cornell University, 1971

While pursuing his graduate studies, L. Daniel Metz was a teaching fellow at the University of Detroit and Cornell University as well as a Ford Foundation fellow at Cornell. During the summers from 1965 through 1969, he was employed by the Ford Motor Co., involved in various design projects. He came to the Department of General Engineering as an assistant professor in 1970 and rose through the ranks to full professor in 1986.

In the summer of 1972, he was selected in the NASA-ASEE Summer Faculty Fellowship Program in Engineering Systems Design at Stanford University. For the academic year 1972-73, he



was awarded a 25% release time under the Sloan Foundation Program to develop an interactions linear systems language for the PDP-11/20 minicomputer to be used in the engineering design program. During the second semester of 1976-77, he was granted a sabbatical leave of absence to further his re-

search and study the systems dynamics aspects of vehicular control and human dynamic response to shock phenomena. He spent his time at Cornell University and the Ford Motor Research and Engineering Center with members of the vehicle dynamics and proving ground sections, and at the University of Houston using their hybrid and digital computing facilities.

In 1980-81, he was on leave without pay and went to the California Polytechnic State University to assist the faculty there to organize and operate a senior-level undergraduate engineering project design course involving university/industry interactions.

He has taught a wide range of courses, including GE 103, GE 104, GE 199, GE 221, GE 222, GE 234, GE 242, GE 293, GE 393, GE 491, GE 493, GE 499, ME 336, and ECE 415. He has received many teaching awards. He has been the inaugural winner of the following awards: Everitt Award for Teaching Excellence, 1971; Ralph R. Teetor Award, Society of Automotive Engineers, 1972; Campus Award for Excellence in Undergraduate Teaching, 1977; Gamma Epsilon Teaching Award, 1981; and College of Engineering Outstanding Adviser Award, 1986.

He has been a thesis adviser to graduate students in the department. He has served on a wide range of departmental, college, and campus committees, including being an elected representative to the College of Engineering Policy and Development Committee and the University Senate.

Metz has devoted his research to vehicle dynamics and safety. He has been called upon by a large number of diversified clients in the United States and Canada as a consultant in accident investigations, including General Motors, Ford, and the Indianapolis Motor Speedway Corp. He has been commissioned by the Society of Automotive Engineers to develop a three-day, eight-hour/day seminar in the field of vehicle dynamics that he conducts three or four times a year. He has published his work in a variety of refereed journals and has appeared as an expert witness in over 100 court trials.

Walter H. Miller

BS, Civil Engr., University of Illinois, 1948

MS, Civil Engr., University of Illinois, 1968

Walter Miller first contacted Jerry S. Dobrovolny, the department head, in November 1963 indicating his interest in getting involved in the teaching and administration of two-year Associate Degree Programs in Civil Engineering Technology as well as going on for a graduate degree. He was employed as an instructor in December 1964.

Prior to his coming to the Department of General Engineering, he had a wide experience in various fields in civil engineering, including highways, inspections, design engineering, and sales engineer for a number of companies. He also served in the U.S. Air Force from October 1943 to April 1946 as a first lieutenant.



ant. His tour of duty included a year of taking courses at the University of Michigan and at Chanute Field, Rantoul, Illinois, in basic and advanced meteorology.

While with the Department of General Engineering, he taught GE 103 and GE 205. He also taught in the Department of Civil Engineering in a program for the state of Illinois Highway Department, preparing civil engineering technicians. His first assignment was to assist in gathering data for an engineering technician need study. He resigned in August 1969 to take a position with Parkland Community College to develop and head up their Construction Technology Program. He also went on for an EdD in technical education from the University of Illinois College of Education.

Mahmood B. Mirza

BS, Liberal Arts Sciences, University of Punjab, Pakistan, 1950

BS, Mining Engr., University of Leeds, England, 1954

MS, Mining Engr., University of Illinois, 1962

PhD, Mining Engr., University of Illinois, 1966

Mahmood B. Mirza was a half-time instructor for the academic year 1965-66 while he completed his PhD. After leaving the University of Illinois, he went to the Department of Civil Engineering at the University of Kentucky.

Manssour H. Moeinzadeh

BS, Mechanical Engr., Youngstown State University, 1973

MS, Mechanical Engr., Youngstown State University, 1975

PhD, Engr. Mechanics-Biomechanics, Ohio State University, 1981

Prior to joining the Department of General Engineering in the fall of 1982 as a visiting assistant professor, Manssour Moeinzadeh had a teaching and research fellowship at both Youngstown University and Ohio State University from 1973 to 1981. In 1981, he was a post-doctoral teaching and research fellow in the Engineering Mechanics Department at Ohio State University. He also had some industrial experience in the period of 1972-75 with several firms such as General Motors Corp., Quaker State Oil Refining Corp., and Bernard Pipeline Co.

During his graduate work, he had support for research in the area of the modeling of human joint structures. His research has been in the field of bioengineering. His funded research at the UIUC has risen to be in excess of \$350,000 and he has been issued two patents as a result with some of his research. He has risen through the ranks to associate professor in 1987, with joint appointments in the Bioengineering Program, the Depart-

ment of Kinesiology, Rehabilitation, Engineering in the Division of Rehabilitation, and the Department of Mechanical and Industrial Engineering.

His teaching has included courses in computer-aided graphics, descriptive geometry, engineering graphics, vibrations, structural stability, statistics, dynamics, finite-element analysis, project design, strength of materials, biomechanics of human joints and advanced mathematics methods in engineering and biomechanics.

He has published widely in refereed journals in the field of bioengineering. He has been recognized by his

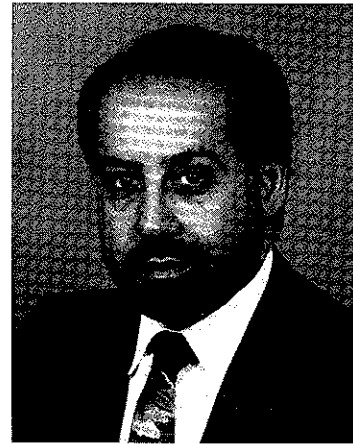

students as being an outstanding teacher. In 1984, he received the Society of Automotive Engineers Ralph R. Testor National Education Award of Teaching Excellence. He has been active in a number of professional societies. In 1988, he was program chair and host of the 12th Annual Meeting of the American Society of Biomechanics.

He has also been active in the Biomedical Engineering Division of the American Society for Engineering Education, having served as session chair, program chair, and a board member. He has been invited to deliver papers at a wide range of universities and technical societies, including an international conference in Iran in 1991. In 1994, he received a United Nations Development Award under the Transfer of Knowledge through Expatriate Nationals project. He plans to use the award during his sabbatical leave in 1994-95 at universities in Teheran, Iran. He will be collaborating on several research projects in the areas of rehabilitation engineering and biomechanics.

His committee work at the University of Illinois has included vice chair of the College of Engineering Executive Committee and secretary of the Engineering Faculty.

Christy A. Murphy

BS, Engr., United States Military Academy, 1948

After leaving the U.S. Military Academy, Christy Murphy was employed as an export sales engineer for



Caterpillar Trucking Co. for two years, and then a partner in a lumber company from 1950 to 1957. He then went with the Canton School District teaching math and science until he came to the Department of General Engineering in the fall of 1962 as an instructor.

While with the department, he taught GE 103 and worked on the

Vermilion County and Lake County Engineering Technician Need Studies, funded by the Illinois Department of Vocational Education. He resigned in August 1965 to assume the duties of department head at the Marine Military Academy in Hastings, Texas.

Howard C. Nelson

BS, Industrial Education, University of Wisconsin, 1930

MS, Industrial Education, University of Illinois, 1942

From 1920 to 1946, Howard Nelson taught shop and drawing in high schools in Clinton, LaSalle-Peru, and Monmouth, Illinois. From 1943 to 1945, he taught physics at Monmouth College. In 1946, he joined the University of Illinois branch at Galesburg, Illinois, where he taught engineering drawing. When the Galesburg branch was closed in 1945, he came to the Department of General Engineering as an instructor. He was promoted to assistant professor in 1959. He retired in June 1967 and taught part-time until the fall of 1969.



In 1958, he published a Handbook of Drafting Rules and Principles that was widely used by high schools. In addition to teaching GE 101 and GE 103, he was in charge of construction of teaching models that were used extensively by other faculty. He also developed bulletin board displays.

Arnold R. Ness

BS, Mechanical Engr., University of Illinois, 1966

MS, Mechanical Engr., University of Illinois, 1968

PhD, Mechanical Engr., University of Illinois, 1974

Arnold Ness joined the Department of General Engineering as a teaching assistant in February 1966 while he pursued an MS degree in mechanical engineering. He was promoted to instructor in the fall 1969 and continued graduate studies toward a PhD, which he obtained in 1974.

While in the department, he taught GE 103, GE 212, GE 232, and GE 393. Upon obtaining his PhD, he resigned to take a position with Bradley University.

David C. O'Bryant

BS, Mechanical Engr., University of Illinois, 1958

MS, Mechanical Engr., University of Illinois, 1961

EdD, Education, University of Illinois, 1970

David C. O'Bryant has had a unique career in that he devoted it entirely to the Department of General Engineering. He began as an undergraduate lab assistant for the first semester of 1957-58. Upon obtaining his BS in February 1958, he served for six months as a lieutenant in the U.S. Army. In the fall of 1958, he returned as a graduate teaching assistant while he pursued a master's degree in mechanical engineering, which he obtained in 1961. He became a full-time instructor in 1960.



At the time he obtained his MS degree, the Department of General Engineering was launching its new integrated project design program covering both machine design and structural design. To better prepare himself to participate in the program, he decided to pursue a PhD in civil engineering. In the summer of 1962, he was accepted as a participant in an NSF sponsored summer institute in structures and soil mechanics at Oklahoma State University.

His involvement in the department drew him more and more in working with students. He also began working with new instructors and graduate teaching assistants teaching the engineering graphics courses GE 103 and GE 101. He was chairman of the engineering graphics course for 26 years. In this capacity, he developed new problems that resulted in his being a co-author on several workbooks on engineering graphics. In 1974, he co-authored a textbook with Jerry S. Dobrovolsky entitled, *Graphics for Engineers*. The book has had several editions.

In conjunction with his in-service training programs for new teachers, he received a \$16,000 grant in 1967 from the Chancellor's Office to develop new techniques in the evaluation of effective teaching, including the use of portable video-tape equipment. Arye Perlberg from Technion in Israel was on campus as a visiting professor and assisted in the project. It was at this time that O'Bryant decided to change his major and went on to pursue an EdD in technical education, which he obtained in 1970.

In 1971, he was selected by the Peace Corps to go to Nairobi, Kenya, to conduct a two-month training program for incoming Peace Corps technical and vocational instructors. He received high praise for his work by the director of the Peace Corps in Nairobi.

His work with students covered a wide range of activities. He served as a faculty adviser for a number of student organizations as well as on a number of college and university committees dealing with students. Within the department he became the chief adviser coordinating all the advising by the faculty in 1979. He also became the assistant department head.

Another area in which he worked with students was a state of Illinois director of the Junior Engineering Technical Society (JETS) from 1968 to 1987. In this capacity, he was in charge of the two-week summer program for high school students about to enter their senior year in high school.

In 1969, he helped organize the first two-week program for inner-city youth called the Minorities Introduction to Engineering (MITE) program. Under the auspices of the Engineering Council for Professional Development (ECPD) other universities were encouraged to conduct programs patterned after the University of Illinois MITE program. At one time, there were 44 schools conducting these programs; many are still being held. In 1974, he was asked by University Communications, Inc., a division of Cox Broadcasting, to evaluate 10 of these programs and prepared a report that was distributed nationally.

For four summers, he taught engineering graphics in the state of Illinois Highway Technicians Program. He also has been involved in the College of Engineering

Summer Pre-Enrollment Program for incoming freshman students. For many years, he was chair of the Engineering Graphics Committee.

His teaching included GE 101, GE 103, GE 104, GE 199, GE 221, GE 231, GE 242, and GE 393. He was involved in the introductions of the new Auto-Cad Unix computers using computers in GE 103, along with Michael Pleck and Thomas Woodley. In 1988, he received the Gamma Epsilon Teaching Excellence Award. In 1990 and 1992, he was awarded the outstanding adviser award of the College of Engineering, and in 1992, he was recognized by the University of Illinois Dads Association as the Outstanding Faculty Member.

He was active in a number of technical and professional societies, including serving as president of the Champaign County Chapter of the Illinois Society of Professional Engineers.

In 1984, he was promoted to associate professor and associate department head. He retired in January 1993, but continued on in an emeritus position on a part-time basis doing advising with the students until 1994.

Eugene I. Odell

BS, Mechanical Engr., University of Michigan, 1955

MS, Engr. Mechanics, Ohio State University, 1969

PhD, Engr. Mechanics, Ohio State University, 1973

From February 1955 to August 1967, Eugene Odell served as a project engineer and rose to assistant chief engineer for Dake Corp. in Grand Haven, Michigan, responsible for various machine design projects. While there he received five patents. While doing his graduate studies, he was a consultant to Metal Flo Corp. in Columbus, Ohio, as well as doing part-time teaching of engineering graphics at Ohio State University. In 1956 and 1957, he was in the navy.

He joined the Department of General Engineering as

an assistant professor in the fall of 1973. He taught GE 103, GE 199, GE 232, GE 241, GE 242, and GE 393. He was highly regarded by his students and fellow faculty members. He left the university on August 20, 1977, to take a position with the University of South Alabama in Mobile.



David R. Opperman

BS, Aerology, California Institute of Technology, 1947

MS, Geophysics, University of Illinois, 1955

Prior to coming to the University of Illinois, David R. Opperman was with the U.S. Weather Bureau in Cincinnati, Ohio, and from



1948 to 1956 he was an instructor with the U.S. Air Force Weather School, Chanute Field, Illinois. He joined the Department of General Engineering as an instructor in September 1956. He spent one year teaching GE 101, after which he was asked by Associate Dean of Engineering Stanley H. Pierce to join

his office as an assistant dean. He was subsequently promoted to associate professor and continued on in the Associate Dean's Office. In 1973, he became director of placement of the College of Engineering. He retired in 1985.

He also had a major role in developing the cooperative education program of the College of Engineering and served as its director from 1972 to 1982. He was very active in a wide variety of civic and professional organizations.

Huo-Hsi Pan

BS, Mechanical Engr., National Southwest Associated University, China, 1943

MS, Mechanical Engr., Texas A & M College, 1949

MS, Applied Mechanics, Kansas State College, 1950

PhD, Mechanical Engr., University of California, 1954

Prior to joining the faculty in the Department of General Engineering in September 1954 as an instructor, Huo-Hsi Pan had various teaching and research assistantships while pursuing his graduate work. He also had summer and part-time positions as a design engineer in

industry. While in the department, he taught engineering drawing and descriptive geometry and worked in the areas of nomography and graphical calculations.

Pan left the University in September 1957 to take a position in the Department of Engineering Mechanics at New York University.

John E. Pearson

BS, Mechanical Engr., Purdue University, 1935

MS, Meteorology, California Institute of Technology, 1943

John E. Pearson joined the faculty of the Department of General Engineering Drawing in September 1939. Prior to joining the faculty, he held positions in several industries as a design and development engineer. He became a full professor in the fall of 1953.

In 1942, he was called to active duty in the U.S. Army Air Corps as a lieutenant and rose to the rank of major. After receiving his MS in meteorology, he served as a staff weather officer for the commanding general of the 20th Army Air Corps in the Pacific. He returned to the university in February 1946.

He then began his distinguished career as a research scientist in meteorology. His early work (1956-57) was with the Illinois State Water Survey and the Argonne National Laboratory, addressing the general problem of radioactive hazards in the atmosphere. In April 1961, he was awarded a grant from the National Institutes of Health to study the transfer of natural radon into the atmosphere. This research was funded for the next four years and is considered to be the baseline research in radon gas emissions into the atmosphere. During this time he established the Atmospheric Science Laboratory in the Transportation Building. He was a prolific contributor of technical articles to many refereed journals including an invited paper at the International Symposium on Atmospheric Chemistry, Circulations, and Aerosols held in Sweden in 1965.

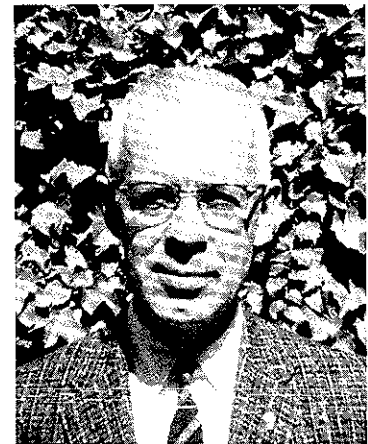

In 1963, he was given a joint appointment in Civil Engineering. In 1966, he was also appointed to the faculty of the Nuclear Engineering Program. In 1967, he was made a senior member of the University of Illinois Center for Zoonoses Research in the College of Veterinary Medicine. In 1968, the governor of Illinois appointed him a commissioner of the Ohio River Valley Water Sanitation Commission. In 1968, he served as

chair of the Illinois Pollution Control Board. In 1971, he was appointed an associate director of the Institute for Environmental Studies in the Graduate College.

Pearson retired on August 31, 1974. His dedication to teaching and research helped greatly in charting the direction of the newly established Department of General Engineering in 1954.

John T. Pendleton

BS, Education, Bowling Green State University, 1964

MS, Education, Bowling Green State University, 1967

EdD, Education, University of Illinois, 1973

Prior to coming to the Department of General Engineering in the fall of 1968, John T. Pendleton taught industrial education at Bowling Green State University while working on his master's degree. As a part-time instructor, he taught GE 103. He also was involved with a research project with the Technical Education Research Center for the Illinois Secretary of State's Office with L. L. Malany, developing lesson plans, course guides, and recommendations for a program in driver's license examiner training for the National Traffic Safety Administration of the U.S. Department of Transportation.

After obtaining his EdD in technical education from Illinois, he returned to Bowling Green, Ohio, and established a very successful contracting business building upscale homes.

Arye Perlberg

BA, Education and History, Hebrew University, Israel, 1953

MA, Education and Social Science, Hebrew University, Israel, 1954

MA, Educational Administration, Columbia University, 1955

EdD, Educational Administration, Columbia University, 1958

Arye Perlberg was a visiting research associate professor with a joint appointment in the Departments of General Engineering and Vocational and Technical Education from September 1966 to June 15, 1968. Prior to coming to the University of Illinois, he was head of the Teacher Training Department at Technion - Israel Institute of Technology, Haifa, Israel.

His work in the Department of General Engineering resulted in a grant from the Chancellor's Office to develop microteaching techniques to improve classroom teaching by using videotapes of live lectures being given by the faculty. The program was highly successful, resulting in a number of articles and papers given at professional society meetings in the United States and Europe.

Monte L. Philips

BS, Civil Engr., University of North Dakota, 1959

MS, Civil Engr., University of North Dakota, 1961

PhD, Civil Engr., University of Illinois, 1970

While at the University of North Dakota, Monte Philips worked six summers as a project engineer for the North Dakota State Highway Department. He was a graduate teaching assistant from 1961-62. He taught statics, dynamics, mechanics of materials, civil engineering laboratory, and indeterminate structures.

In 1962-63, he went as an instructor to Ohio Northern University and taught soil mechanics, mechanics of



materials, surveying, and fluid mechanics lecture and laboratory. He came to the Department of General Engineering as an instructor pursuing a PhD in civil engineering in the fall of 1963. For the academic year 1965-66, he was the recipient of the Ford Foundation Faculty Development Loan Program, which enabled him to devote full

time to his studies. He completed his PhD in 1970 and accepted a position as associate professor at the University of North Dakota. He became very active in the National Society of Professional Engineers and was elected president for the 1994-95 year.

While at the Department of General Engineering, he taught GE 103, GE 104, GE 221, and GE 241. He was also active on a number of departmental committees.

Stanley H. Pierce

BS, Railway Engr., University of Illinois, 1932
MS, Electrical Engr., University of Illinois, 1939

Stanley H. Pierce was appointed an instructor in the Department of General Engineering Drawing in September 1936 and rose through the ranks to professor and associate dean of the College of Engineering in September 1953.

He served in the navy during World War II from November 1, 1944, to February 1, 1946, and upon his return, became an assistant dean of the College of Engineering. During the 1952-53 academic year, he succeeded Associate Dean Jordan, who retired in 1953.

Pierce was instrumental in transferring the administration of the general engineering curriculum to the new Department of General Engineering, as well as moving the drawing courses and other service courses in the college to the new department. The necessary approvals were obtained from the College Policy and Development Committee, since the logic for this transfer was very clear, and the advising for the students in the general engineering curriculum was already being done by C. H. Springer and J. S. Dobrovolsky.

Pierce's untimely death in 1966 cut short an outstanding academic administrative career.



Ronald J. Placek

BS, Mechanical Engr., University of Illinois, 1958
MS, Theoretical and Applied Mechanics, University of Illinois, 1959
PhD, Theoretical and Applied Mechanics, University of Illinois, 1963

Ronald Placek joined the Department of General Engineering in the fall of 1957 as an undergraduate senior assistant. In the fall of 1958, he became a graduate assistant while pursuing a master's degree in theoretical and applied mechanics. In 1959, he became an instructor, in 1963, an assistant professor, and an associate professor in 1968.

He played a vital role in the development of the Integrated Engineering Design sequence of courses that were introduced into the curriculum in 1961. His aca-

ademic studies plus his experience as an apprentice tool and die maker from 1951 to 1953 prior to starting his University studies made him invaluable in assisting in the development of the design courses.

In the 1960s, when the Department of General Engineering and the College of Engineering Technical Education Advisory Committee were active in the development of the concept of two-year associate degree programs in engineering technology, he was instrumental in organizing the technical mathematics course in the programs. He wrote a textbook entitled *Technical Mathematics with Calculus* that was widely adopted by community colleges and technical institutes. During the 1960s, he also taught in the National Science Foundation Summer Institutes and Academic Year Institutes for upgrading technical education teachers.

In the summer of 1966, he was selected as a participant to a four-week conference on Case Studies in Engineering Design held at Stanford University sponsored by NSF. In the summer of 1967, he received an NSF grant to conduct a summer institute on Case Methods of Teaching Engineering Design in Chicago.

In 1967, he was a recipient of a Ford Foundation program for a year in industry to work for General Electric Co. in Schenectady, New York. This was for the academic year 1967-68 and he was on leave of absence for that year. He returned to the department for 1968-69; however, he then requested a leave without pay for the 1969-70 year to go back to General Electric. He subsequently resigned in the fall of 1970 and stayed with General Electric to head up its Turbine Design Division.

While in the department, he taught and helped develop GE 101, GE 102, GE 212, GE 232, GE 313, GE 242, and GE 393. He also was elected as the department representative to the College of Engineering Policy and Development Committee. He was sorely missed by his colleagues when he did not return to academic life.

Michael H. Pleck

BS, Mechanical Engr., University of Illinois, 1964
MS, Mechanical Engr., University of Illinois, 1966
PhD, Mechanical Engr., University of Illinois, 1970

Michael H. Pleck graduated with University Honors and his name appears on the Bronze Tablet. He began teaching in the Department of General Engineering as a laboratory assistant while a senior in Mechanical Engineering. He became a graduate assistant in 1964 as he pursued his graduate degrees. He became an assistant professor in 1970, and an associate professor in 1976. In 1993, he became the associate head of the Department of General Engineering.

Early in his teaching career, Pleck became interested in the use of computers in engineering graphics. From 1969-71, he offered a one-hour EngH 297 course to investigate the use of computer graphics on then present day

computers such as the IBM 7094/CALCOMP Plotter System for computing graphics. This was followed by co-developing the specifications for the stand-alone computer graphics facility, hardware, plotter, interfacing, systems, and software package obtained on a Ford Foundation grant. This resulted in the development of the Illinois Graphics Computing System (IGCS) integrating the electrostatic printer/plotter (Gould 4800) with the PDP-11/20 minicomputer for use in teaching computer graphics.

During the second semester of 1979-80, he went on sabbatical leave as a visiting fellow at the Cornell University Sibley School of Mechanical and Aerospace Engineering, working on the TIPS-1 (Technical Information Programming System) expanding mass property determinations in solid modeling systems. Various other phases of his work related to geometric modeling systems. After his stay at Cornell, he spent the summer of 1980 at Hokkaido University in Japan doing further research on TIPS-1.

As a result of discussions with IBM in conjunction with the IBM-granted CADD-CAM Laboratory established in 1980-82, IBM donated millions of dollars worth of IBM PCs to the University of Illinois under a project called EXCEL (Excellence in Computer-Aided Education and Learning). In the summer of 1984, the Department of General Engineering received one of the first 10 awards to the university under Project EXCEL, valued at \$335,370, plus additional funds from the university. The funds were used to establish a 30-work station IBM-PC laboratory to teach GE 103, Engineering Graphics.

During the second semester of 1984-85, half of the students taking GE 103 took the course under the traditional mode of teaching while the other half were taught using the IBM-PC mode. At the end, the evaluation showed there was a statistically significant increase in achievement using the PC mode. The word spread quickly about the new method so that the next semester, everyone wanted to be taught the new way.

To meet this demand, additional modifications were made during the summer of 1985 to establish a 100-seat auditorium with a large screen projector tied in with the PC lab to demonstrate how to use the computers. In addition, in 1986, to meet the demand 27 Zenith PCs were donated and another classroom was converted to a Graphics PC Laboratory.

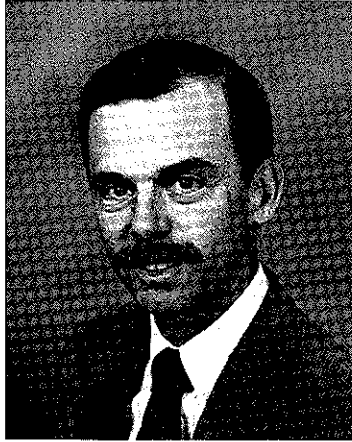

Another important facet of the success of the program was the integration of the Auto-CAD software package. Pleck and Woodley developed several innovative uses of this software to be more useful in engineering graphics instruction.

Pleck has always been recognized as an outstanding teacher. In 1974, he was awarded the College of Engineering Everitt Award for Excellence in Teaching. In 1975, he was awarded the Campus Award for Excellence in Teaching. In 1976-77, he received the Campaign-Urbana Jaycees Outstanding Young College Educator Award. In 1980, he was a recipient of the SAE Tetor Award. In 1983, he was awarded the ASEE Western Electric Fund Award for Excellence in Instruction of Engineering Students. In 1990, he was awarded the inaugural NCGA MicroCADD Academic Award. In 1991, he shared with Woodley the EDUCOM Joe Wyatt Challenge Award. He has taught a wide range of courses, including GE 103, GE 104, GE 212, GE 221, GE 242, and EngH 297.

Francis M. Porter

BS, Electrical Engr., Ohio University, 1907
MS, Physics, University of Illinois, 1911

Francis M. Porter began his career at the University of Illinois as an assistant in the fall of 1907 teaching mechanical drawing. He rose through the ranks to full professor in the fall of 1946. His area of expertise was in Euclidean geometry. He chaired the descriptive geometry course committee and co-authored several textbooks on the subject. Porter was active in the American Society for Engineering Education and was editor of the T-Square page



in the *Journal of Engineering Education*. He also delivered papers at technical society meetings.

He retired on September 1, 1949, and died in April 1953.

He retired on September 1, 1949, and died in April 1953.

Maurice G. Porter

LLB, University of Illinois, 1938
JSD, University of Illinois, 1960

Maurice Porter attended Miliken University in Decatur, Illinois, and Illinois State University in Normal between 1924 and 1935 and then enrolled in law school at the University of Illinois where he graduated cum laude. From 1938 to 1958, he was in the general practice of law in Clinton, Illinois. In 1958, he returned to obtain his JSD degree. In September 1959 to June 1960, he was a half-time assistant professor in the Department of Civil Engineering teaching contracts and specifications. In the fall of 1960, he also taught agricultural law half time in the College of Agriculture. In September 1961, he started in the Department of General Engineering on a one-third time basis, teaching engineering law and joined the faculty on a full-time basis in the fall of 1963 as an associate professor. He resigned in May of 1972 to join the faculty at Western Illinois University to assist in the development of a new degree program in law enforcement administration.

Subramanian Ramamurthy

BTech, Civil Engr., Indian Institute of Technology, India, 1970
MSc, Civil Engr., University of Madras, India, 1972
PhD, Theoretical and Applied Mechanics, Cornell University, 1977

Prior to coming to the Department of General Engineering in the fall of 1977 as a visiting assistant professor, Subramanian Ramamurthy worked for a short time as a junior engineer in the Water Supply Department in Madras, India. While at the university, he taught GE 103, GE 193, GE 232, and GE 242. The Department of General Engineering spent a great deal of time in assisting him to obtain a "green card" in 1978, at which time he was appointed as an assistant professor. He resigned in July 1979.

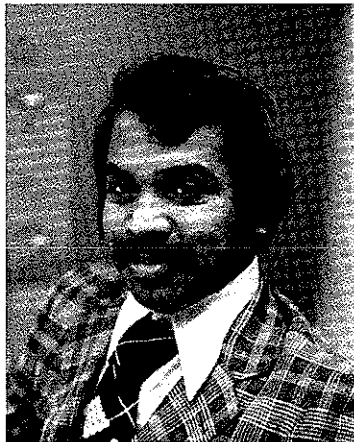

Jahangir C. Rastegar

BS, Mechanical Engr., Southern Methodist University, 1969
MS, Mechanical Engr., Stanford University, 1972
PhD, Mechanical Engr., Stanford University, 1977

Jahangir Rastegar joined the faculty of the Department of General Engineering as a visiting assistant professor in the fall of 1977. Upon arrival, he also was accepted as a member of the College of Engineering Bioengineering Faculty. His research activities were in the area of structural dynamics of the human leg studying the stiffness characteristics of the ankle joint, hip joint, and spinal column.



He taught GE 103, GE 193, GE 221, and BioEng 270. Unfortunately, his fruitful career at the University of Illinois was cut short when he resigned in February 1980 because of personal circumstances beyond his control.

Henrique L. M. dos Reis

License in Mech. Engr., Universidade de Luanda, Angola, 1972
SM, Mechanical Engr., Massachusetts Institute of Technology, 1975
PhD, Mechanical Engr., Massachusetts Institute of Technology, 1978

Prior to coming to the Department of General Engineering in January 1980, Henrique Reis served a year as an assistant professor of mechanical engineering at the Universidade Estadual de Campinas, Brazil, for the academic year 1978-79. He began as an assistant professor and was tenured as an associate professor in 1987. He has been active in a wide range of technical societies. He is a fellow in the British Institute of Non-Destructive Testing, as well as of the Acoustic Emission Working Group. He is a member of the Research Council and of the Educational and Qualification Council of the American Society for Nondestructive Testing (ASNT). He has been elected to the chair of the University Programs Committee of the ASNT Education Division.

His area of research is the field of nondestructive testing of materials and structures, quality control inspection methods in manufacturing, mechanics of composite materials and design of composite structures, and dynamic elastic-plastic behavior of anisotropic structural elements. In 1987, he received grants from the National



Science Foundation, NASA Lewis Research Center, Sundstrand Aviation, Monsanto Co., Amoco, and Weyerhaeuser Corp. to establish the Nondestructive Testing and Evaluation Research Laboratory. The grants and donations have exceeded \$450,000.

He went on sabbatical leave during the first semester of 1990–91 with the Center for Nondestructive Evaluation in the Department of Materials Science and Engineering at John Hopkins University. While there, he continued his study of the measurement of material microstructure and associated factors that govern mechanical properties and dynamic response. The work provides a nondestructive approach to characterizing engineering solids and their gradations or modifications on exposure to severe environments.

He has published widely in refereed journals and conference proceedings. He has co-authored chapters in two books and served as an editor for several books.

In his teaching, he is known as a task master. His diligence with both his students in GE 242 and his master's degree students has been rewarded by his students receiving 11 awards in the National James F. Lincoln Arc Welding Foundation Engineering Design Competition, in Cleveland, Ohio, between 1980 and 1993. The awards range from First Awards to Merit Awards. Two of his 12 master's degree students have received the William A. Chittenden Award for the best thesis submitted in general engineering. He has taught GE 221, GE 232, GE 241, GE 242, GE 234, GE 293, and GE 493. He was appointed on a zero-time basis in 1990 to the Department of Mechanical and Industrial Engineering.

David R. Reyes-Guerra

- BS, Civil Engr., The Citadel, 1954
- M. of Engr., Yale University, 1955
- PhD, Engineering (Honorary), Lawrence Institute of Technology, 1984
- PhD, Engineering (Honorary), The Citadel, 1986

David R. Reyes-Guerra began with the Department of General Engineering in the fall of 1957, and at the same time began work toward his PhD in civil engineering. He was a native of Guatemala and after obtaining his master's degree, he worked as a project engineer for United Fruit Co. before coming to Illinois. During his tenure at the University of Illinois, he managed to get involved in a wide range of activities, including a grant from the state of Illinois to develop a licensing procedure for motorcycle driving.

In 1962, he was one of the faculty who developed the courses in the general engineering design sequence and taught several of the courses. Early in the development of the general engineering design courses, contact had been made with Morris Asimow at UCLA who also was developing design courses for UCLA. Asimow was involved with Brazil in developing design education. He invited Reyes-Guerra and Bernt O. Larson to accompany him on several trips to assist him in his project. Reyes-Guerra also obtained a Ford Foundation grant for a mission to go to the Philippines for a preliminary study for improving their engineering education system.

In 1961, he began as the state of Illinois Director of the Junior Engineering Technical Society (JETS). He was a prime mover in developing the two-week summer

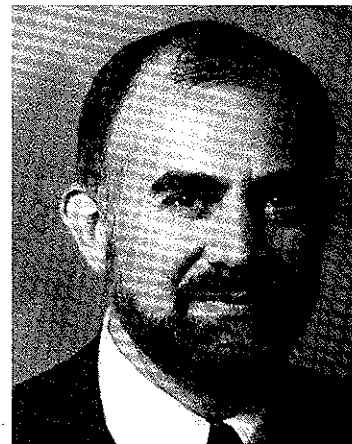

JETS program that became a model nationally. He organized high schools to begin JETS chapters. He also organized the state JETS fair. Dean W. L. Everitt in a letter dated December 2, 1964, wrote, "... JETS, is making a great impact, not only on the students involved and on the College of Engineering, but in the high schools from which our

participants come." As early as 1963, he was invited to apply for the position of national director of JETS. He was called constantly as a consultant for the JETS national office. In August of 1967, he was given a year leave of absence to serve as executive director of the JETS national office and as secretary of guidance for the Engineers Council of Professional Development (ECPD) in New York City.

While there in 1968, he was named a consultant representative to the Pan-American Federation of Engineering Societies (UPADI). He traveled to South America many times. In June 1968, he was granted another year leave without pay for the 1968–69 academic year. During all this time, he still had hopes to return to the university to complete his dissertation for a PhD in civil engineering. However, his work with JETS and ECPD was so stimulating that he resigned from the university in 1969. In 1972, he went on to become the executive Director of ABET (the Accreditation Board of Engineering and Technology). He served in that capacity until 1993 when he retired. In 1984–86, he served as president of

JETS. He has two honorary doctorate degrees from The Citadel and the Lawrence Institute of Technology. In July 1994, he was honored by NSPE with the Distinguished Service Award. He has been active in a wide range of professional societies and has received numerous honors and awards for his work in engineering education, both nationally and internationally.

Donald H. Rimbey

BS, General Engr., University of Illinois, 1950
MS, Mechanical Engr., University of Illinois, 1962
PhD, Mechanical Engr., University of Illinois, 1967

After completing his BS degree in general engineering, Donald Rimbey worked for four years (1950-54) as a design engineer for Metron Instrument Co. in Denver, Colorado, on miniature precision mechanical components in servo mechanisms. From 1954-56 he was with Foot Bros. Gear and Machine Corp. in Chicago, Illinois, designing electro-mechanical components for aircraft and guided missile industries. From 1956-59, he was a field engineer for the Foxboro Co. in Foxboro, Massachusetts, involved in the installations of automatic control systems.

In May 1959, he contacted R. P. Hoelscher, department head, indicating he was interested in teaching and pursuing graduate studies. He joined the faculty in the fall of 1959 as an instructor and began doing graduate work. He earned his master's degree in 1962 and a PhD in 1967. He was on leave of absence during the second semester of 1964-65 on a Ford Foundation grant and also in 1965-66 with an NSF Faculty Fellowship. He taught GE 104, GE 232, GE 236, GE 242, GE 293, and GE 360. Upon obtaining his PhD, he resigned in May 1967 to take a position with the University of South Florida in Tampa, Florida.



Lisle Abbott Rose

Ph.B, English Literature, University of Chicago, 1925
MA, English Literature, University of Chicago, 1928
PhD, English Literature, University of Chicago, 1935

Prior to coming to the University of Illinois, Lisle Rose was on the staff of the Michigan College of Mining and Technology in Houghton, Michigan. He joined the staff there in 1928 as an instructor in English and rose through the ranks to be professor of English and head of the Department of Languages. From 1945 to 1947, he served as director of public relations.

He joined the College of Engineering at the University of Illinois on February 1, 1947, as an associate professor and editor of engineering publications. In September 1947, he was promoted to full professor. In September 1951, he became the director of engineering information and publications, and in 1954, his professorship was assigned to the Department of General Engineering.

He was a fellow of the Royal Society of Arts and active in the College English Association Institute. He was a member of the Association of the United States Army, the American Academy of Political Science, the History of Science Society, the American Association of University Professors, Rotary, the Illini Railroad Club, Blue Key, Delta Sigma Phi, and Quadrangle.

He was very active in the American Society for Engineering Education beginning 1938. He founded the Michigan Tech branch, became its first chairman, and was president-elect of the four-state North Midwest Section when he moved to Illinois in 1947. He served as vice-chair of the ASEE English Division, as well as many national committees and for three years as chair of the Public Relations Committee. In April 1955, he was named to the post of public relations director of ASEE. He was recognized as one of the outstanding editors and one of the best public relations men in the field.

At the university, he provided the breath that helped bridge the gap between north and south Green Street.

On February 1, 1952, he wrote a memo to Dean W. L. Everitt, recommending a committee to be appointed to develop a course on the nature of engineering for nonengineering students. Dean Everitt appointed a Committee on Engineering Philosophy and Methods

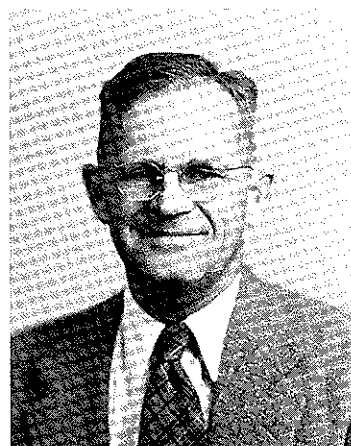

with members from each department. The first meeting took place on February 20, 1952, with Rose as co-chair with the dean. The committee met for over a year and a half, inviting faculty and deans from other colleges to share their input for the course.

The course that evolved was GE 250, Engineering and Western Civilization, which was approved March 30, 1953. Jerry S. Dobrovolny, who was a member of the original committee, was identified to teach the course. He did for several semesters; however, it was discontinued for lack of student enrollment.

Lisle A. Rose's untimely death on May 23, 1955, brought an end to an outstanding career that was just being readied to achieve greater heights. In 1957, friends of Lisle A. Rose established the College of Engineering Lisle Abbott Rose Award to be awarded to an outstanding senior student in engineering who most nearly approaches the ideal of technical excellence, combined with cultural depth and sensitivity.

Mildred Mattux Rose

In the spring quarter of her freshman year at the University of Chicago, Mildred Mattux met Lisle A. Rose. She was studying English literature as he was. They were married shortly after they met.

After Lisle A. Rose passed away in May 1955, Mildred Rose moved to Algonquin, Illinois, to live with his mother, and took a position as an editor with Consolidated Publishing Co. in Chicago. In September 1967, she joined the staff at the University of Illinois in Chicago as editor of publications. In 1968, she became director of publications and an assistant to the vice chancellor until 1973, when she retired and returned to Urbana.

In March 1981, Rose was appointed a special assistant to the head of the Department of General Engineering. Her duties were to be editor of the alumni newsletter as well as various other publications of the department. She served in this capacity until June of 1983.

In 1995, she established the Mildred Mattux and Lisle Abbott Rose Scholarship in the Department of General Engineering with a \$50,000 endowment. The award is to be given to a sophomore or junior in general engineering based on outstanding academic accomplishment, extracurricular activities, and cultural breadth, including music, history, and the arts. The award provides \$500 per semester for two semesters.

Roland L. Ruhl

BS, Mechanical Engr., Cornell University, 1965

MBA, Cornell University, 1966

PhD, Mechanical Engr., Cornell University, 1970

While at Cornell University pursuing his graduate studies, Roland L. Ruhl taught engineering graphics, kinematics, and dynamics. During the summers, he was employed by several corporations doing industrial engineering work. In 1968, he attended a summer program



in computer-aided design sponsored by NASA MSC and the University of Houston, where he met Bernt O. Larson. This meeting led to his joining the Department of General Engineering in June 1970 as an assistant professor. During the summer of 1970, he worked on the Ford Foundation grant the department had to develop the inte-

grated design sequence. Since the funds from the grant were to run out, Ruhl began the program by contacting various industrial firms for the financial support and supplying GE 242 Project Design projects. The sponsoring companies also assigned staff engineers to work with the students and faculty on the projects. By 1973, all projects were supported by industrial firms. Beginning in 1972, an annual design conference was held whereby each student project team made a presentation before industry representatives. Along with the conference, an annual design brochure was printed listing all projects.

During the second semester of 1971-72 and for the academic year 1972-73, Ruhl had a half-time appointment in the Department of Architecture. He worked with the National Clearing House for Correctional Programming developing a predictive mathematical model

utilizing computer-aided instruction for correctional institutions such as the Illinois Graphics Computer System (IGCS). Several GE 242 projects and master's degree projects evolved from this work.

In 1972, Ruhl and M. H. Pleck using funds from the Ford Foundation engineering design grant, acquired a Digital Equipment Corp. PDP-11/20 stand-alone mini-computer. This represented a state-of-the-art breakthrough for the department in providing direct designer-computer interactions, a concept now standard. The facility provided a vehicle for allowing articulation in graduate research between the department and the Department of Computer Science and William C. Gear, in particular.

He was granted a leave of absence without pay in 1973-74 to assist in the management of his family business in Freeport, Illinois. The leave was extended for an additional year. It became clear that his family would no longer be able to manage the business without him, so he resigned in the fall of 1975. During the period of 1973 through 1985, Ruhl solicited projects for GE 242 and being an adviser for some of the projects.

In 1985, he continued in the capacity as an adjunct professor, working with Howard Cannon, director of the University of Illinois Advanced Manufacturing Center located in Rockford, Illinois, offering short courses for practicing industry engineers to make manufacturing operations more efficient. He started the Technology Audit and Assessment Program, which provided consulting services to small Illinois industries in making plant, product, and process more efficient. The state of Illinois funded some of the studies through the DCCA industry grant program. The College of Engineering provided a "seed money" grant of \$20,000 to assist in the development of this program, which became self-sufficient. This led to various industries becoming interested in other departmental programs, such as projects for GE 242, faculty research, and graduate student support. After the family business was sold, Ruhl gradually became more and more involved with the departmental Technical Audit Program and GE 242, as well as maintaining his engineering consulting business. In 1991, he moved back to Champaign, locating his consulting business there, and continuing his adjunct professorship working with the GE 242, Project Design, as well as master's degree students. He has taught GE 103, GE 241, GE 242, and GE 393.

His research interests are in software support for microcomputer intelligent measurement and control; simulation of dynamic systems; dynamic systems; and vehicle dynamics, particularly as they relate to accident reconstruction.

Donald E. Scheck

BS, Mining Engr., University of Illinois, 1952
MS, Industrial Engr., University of Illinois 1958
PhD, Industrial Engr., Purdue University, 1966

Upon graduation in 1952, Donald E. Scheck was employed as a production engineer with the Freeport Sulphur Company of New Orleans, Louisiana, and Freeport, Texas. He joined the Department of General Engineering in September 1954 as an instructor. He was promoted as assistant professor in 1959.

During the first semester of 1960-61, he was on a leave of absence to establish his one semester of residence requirement for his PhD program. He again was on leave without pay for the academic year 1967-68 and 1968-69 to complete the research for his PhD.

While teaching, he taught GE 104, GE 228, and GE 242. His contributions to Project Design in both GE 104 and GE 242 were extremely important during the formulative years of the design sequence of courses in general engineering.

His research interests were in analysis and control as applied to project management, in particular the statistical nature of inventory control. Upon obtaining his PhD, he resigned in September 1969 to take a position with Ohio University in Miami, Ohio.



Morris Scheinman

BS, Civil Engr., College of the City of New York,
1935
MS, Civil Engr., College of the City of New York,
1936

Morris Scheinman joined the Department of General Engineering as an assistant professor in December 1962. Between 1936 and 1962, he worked for a wide variety of engineering firms including the U.S. Geological Survey, the U.S. Naval Department Bureau of Ships, and several consulting engineering firms. From 1958 to 1962, he was

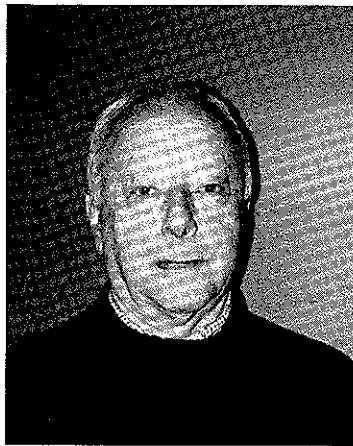

a lecturer in structural engineering. His practical experience assisted the Department of General Engineering in establishing its project design oriented design courses. He taught a wide range of courses including GE 103, GE 104, GE 105, GE 199, GE 221, GE 231, GE 241, GE 242, and GE 393. A number of his students

were awarded Lincoln Arc Welding Design Awards for their project designs in GE 242. He retired in May 1983. However, he continued on a part-time basis until May 1990.

Wayne L. Shick

BS, Architecture, University of Illinois, 1940
Architect Certificate, State of Illinois, 1950

Upon graduation, Wayne L. Shick entered the U.S. Army and served overseas from July 1940 to October 1943. After that, he held several positions with various companies as an illustrator and doing architectural design until he joined the Department of General Engineering in September 1945 as a teaching assistant. He rose through the ranks to professor in 1960.

During his time with the department, he was responsible for the architectural projection courses GE 107 and GE 108 for architecture students. He co-authored a number of workbooks as well as contributing a chapter on architecture in a text book. He was an excellent illustrator and received a patent on a device for orthographic-isometric projection. He also taught GE 210, Production Illustration.

When the Department of Architecture revised its curriculum and no longer required GE 107 and GE 108, Shick transferred to the Small Homes Council where he was employed until his retirement in August 1979.

William O. Smith, Jr.

William O. Smith, Jr., was employed as a technical associate in the Department of General Engineering in August 1966 to head up the program of developing a one-year certificate program in horology and a two-year associate degree program in Micro-Precision Technology under a grant from the U.S. Office of Education which had been obtained by Jerry S. Dobrovolny.

Prior to coming to the university, he had been with the Western Pennsylvania Horological Institute, serving as chief instructor 1946-47, director of research 1947-51; vice president, director of training 1952-66. He had written 35 technical pamphlets on chronography and numerous repair manuals.

Others on the project included members of the college's Engineering Technology Curriculum Advisory Committee. The two curricula were developed and a one-semester pilot program of 25 students was conducted. In 1968, the program with all of the instructional equipment was transferred to Parkland Community College in Champaign, Illinois, with Smith heading the program. The graduates had wide acceptance in the watchmaking and instrumentation fields.

Fred L. Spalding

BS, Mechanical Engr., University of Illinois, 1935
MS, Vocational Educ., Stout Institute, 1950

Fred L. Spalding joined the department in the fall of 1953 as an instructor and was made an associate professor in 1959. Prior to coming to the University of Illinois, he had wide exposure as a consultant in industrial engineering in the area of geometrical form tolerancing. He continued the work in the department and developed a course, GE 330, Industrial Standardization. He was active in the American Structural Association, chairing the Sectional Committee Y-14 on American Drawing Standards.

He was called on often to conduct seminars on the broad field of geometric and positional tolerancing. He retired in 1970 and died on January 6, 1981.

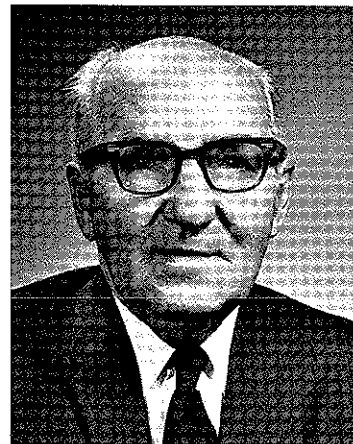

Mark W. Spong

BA, Mathematics and Physics, Hiram College,
1975

MS, Mathematics, New Mexico State University,
1977

MS, Systems Science, Washington University, 1979

PhD, Systems Science, Washington University,
1981

Prior to joining the Department of General Engineering, Mark W. Spong was an assistant professor at Lehigh University for 1981–82 and at Cornell University from 1982–84 where he taught systems courses and robotics in the Electrical Engineering Department. He joined the department in 1984 as an assistant professor and rose to the rank of full professor in 1990.

His research activities continue to be in control systems and robotics. In 1987, he received funding for establishing a robotics laboratory. He has worked closely with colleagues at the Decision and Control Laboratory in the college's Coordinated Science Laboratory. In the second semester of 1990–91, he was granted a sabbatical leave to further his research in adaptive control of robot manipulators. He spent his time at the Instituto Politecnico Nacional de Mexico, the University of California at Berkeley, the Laboratoire d'Automatique de Grenoble, France, and at the Department of Automatic Control, Lund Institute of Technology, Lund, Sweden. He also visited institutions in Wales, Germany, Norway, and Italy.

He has developed three new courses in robotics with the class notes for GE 389 being published as a textbook. Other courses he has taught are GE 222, GE 242, GE 293, GE 389, GE 493, and ECE 371. He serves as a supervisor to master's and PhD candidates. He has been called upon to present short courses at various universities and technical societies. He has taught courses in the Department's Electrical and Computer Engineering, as well as being involved in the development of an undergraduate option in manufacturing.

The robotics laboratory provides a sequence of exercises and projects in robotics, vision, control, and simulation and is being used in other course such as GE 222, GE 491, GE 495, and for research by graduate students.

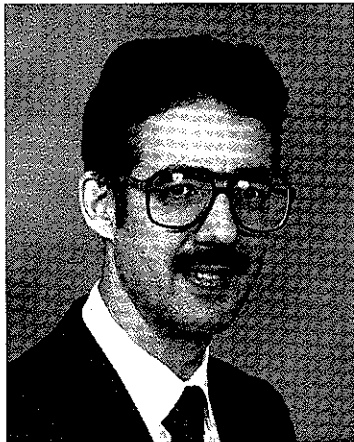

He has published widely in refereed journals and conference proceedings and has written two books. He has been recognized by his peers by being elected a senior member of the Institute of Electrical and Electronics Engineers.

Spong is an associate editor of the *IEEE Transactions on Control System Technology*, an associate editor of the *IEEE Transactions on Robotics and Automation*, and a past associate editor of both the *IEEE Control Systems Magazine* and the *IEEE Transactions on Automatic Control*. Spong is a member of the Board of Governors of the IEEE Control System Society and is the chairman of the Working Group in Robotics and Automation of the IEEE Control Systems Society.

He received best paper awards at the 1987 Robotics and Expert Systems Symposium and at the 1988 IEEE Conference on Decision and Control.

Herbert J. Sprengel

BS, Engr. Physics, University of Illinois, 1936

MS, Physics, University of Illinois, 1937

Herbert J. Sprengel joined the Department of General Engineering in the fall of 1968 as an assistant professor.



Prior to coming to the department he had a distinguished career in engineering in the development and the manufacture of x-ray equipment. He had served as a design engineer, quality control supervisor, and manufacturing engineering supervisor to name a few. His background served the department in project design

courses as well as working with freshmen in GE 103 and GE 104. He retired in 1978. Upon his retirement he established the Herbert J. Sprengel Award described in Chapter 6.

Clifford H. Springer

BS, Civil Engr., Ohio State University, 1917

MS, Theoretical and Applied Mechanics, University of Illinois, 1929

CE, Ohio State University, 1929

Upon graduation Clifford Springer worked for the Pennsylvania Railroad during 1917–18. In World War I he was commissioned a second lieutenant and later rose to the rank of captain, serving in the Argonne in France

from 1917 to 1920. After the war he spent four years as a resident engineer in the St. Louis County Highway Department in Duluth, Minnesota.

He joined the Department of General Engineering Drawing in September 1924 as an instructor and became a full professor in 1943. He co-authored a number of textbooks and workbooks in engineering drawing and descriptive geometry.

Perhaps his greatest contribution was in his role as adviser for the general engineering curriculum. Until September 1953, the curriculum of general engineering was officially administered from the Office of the Associate Dean of Engineering. However, since Associate Dean Jordan was also the head of the Department of General Engineering Drawing, Springer actually provided the glue that held the general engineering curriculum together. He continued to be the principal adviser until his retirement in 1962.

He was active in the Engineering Graphics Division of the American Society for Engineering Education, serving as secretary and chairman. He received its Distinguished Service Award in 1960. He also was active in the American Standards Association.

Ramavarapu S. Sreenivas

B.Tech., Electrical Engr., Indian Institute of Technology, India, 1985

MS, Electrical Engr., Carnegie Mellon University, 1987

PhD, Electrical Engr., Carnegie Mellon University, 1990

Upon obtaining his PhD, Ramavarapu S. Sreenivas was awarded a post-doctoral fellowship in applied science at Harvard University for the academic years 1990-92. He joined the Department of General Engineering as an assistant professor in the fall of 1992, with joint appointments in the Coordinated Science Laboratory and at the Department of Electrical and Computer Engineering.



His general area of research is in the discrete event dynamic systems an emerging area of research that models manmade systems. Applications include manufacturing systems and integrated vehicle highway systems, both of which are vital to the economic growth of the country and require discrete event dynamic modeling and optimization as an enabling technology.

He has papers published in refereed journals and conference proceedings. He has taught GE 222, GE 242, GE 393, and GE 493, as well as supervised graduate students. He is a member of the College of Engineering Controls Laboratory Steering Committee that has developed a collegewide controls laboratory course, GE 224, Dynamic Systems Laboratory, which he also teaches.

William E. Stallman

BS, Civil Engr., University of Illinois, 1950

Prior to coming to the University of Illinois in the fall of 1966, William Stallman was employed by the Illinois Division of Highways from 1950 to 1966, leaving as district traffic engineer in Carbondale, Illinois. In discussing his future career goals with Ellis Danner of the Department of Civil Engineering, Stallman decided to pursue a master's degree in civil engineering. Danner arranged with Jerry S. Dobrovolny for an instructorship in the Department of General Engineering.

Shortly after his arrival, Dobrovolny was contacted by H. D. Bareither, then director of the Central Office on the Use of Space, who was looking for someone to assist him in that office. During the second semester 1966-67, Stallman joined the Office on the Use of Space on a half-time basis. In the fall of 1967, he became full-time as the director of space utilization and was promoted to associate professor in 1974. He retired as the director of space utilization in October 1987.



Paul W. Steinbeck

BS, United States Military Academy, 1929
EdM, University of Illinois, 1959

Upon graduating from the U.S. Military Academy, Paul W. Steinbeck became a regular army officer from 1929 to 1959. He served the army with distinction, being decorated with the Silver Star, four Bronze Stars, Combat Infantry Badge, Parachutist's Badge, and several foreign awards. He rose to the rank of colonel on November 4, 1944. He came to the University of Illinois in June 1956 to be the professor of military science and tactics for the Army ROTC and served in that capacity until his retirement from the army on July 31, 1959. In the fall of 1959, he joined the Department of General Engineering.

Steinbeck's teaching responsibilities were in the teaching of GE 220, History of Engineering. In March 1963, he was called by the university to be the associate director for Civil Defense. He returned to the Department of General Engineering in the fall of 1966 where he continued to teach GE 220 as well as GE 103, Engineering Graphics. He retired in May 1975.

Jerry E. Stoneking

BS, Engr. Mechanics, Georgia Institute of Technology, 1965
MS, Theoretical and Applied Mechanics, University of Illinois, 1966
PhD, Theoretical and Applied Mechanics, University of Illinois, 1969

Jerry E. Stoneking was an assistant professor in the Department of General Engineering. From 1970-73, he was at Clarkson University. In 1973-74, he was at the University of South Carolina. In 1974, he went to the University of Tennessee as an associate professor in the Department of Engineering Science and Mechanics; became head of the department in 1984 and Dean of the College of Engineering in 1992.

His research interests are in structural mechanics with emphasis on computational methods, pressure vessel analysis and micro-matching of optical components.

Mark G. Strauss

BS, Mechanical Engr., Polytechnic Institute of New York, 1979
MS, Biomedical Engr., University of Virginia, 1981
PhD, Biomedical Engr., University of Texas, 1987

While obtaining his master's degree in biomedical engineering, Mark G. Strauss was also a graduate of the Rehabilitation Engineering Traineeship Program at the Rehabilitation Engineering Center in Charlottesville, Virginia. He came to the University of Illinois in the fall of 1987 as an assistant professor with a joint appointment in the Division of Rehabilitation Education Services and the Department of General Engineering.

His teaching has been in the two departments and

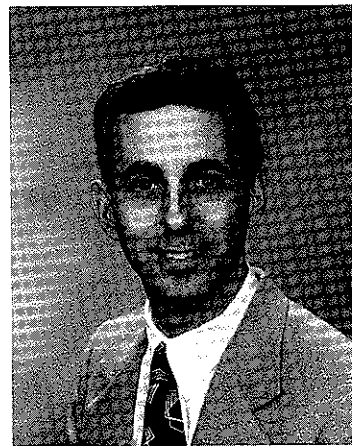

includes the following courses: GE 221, GE 234, GE 242, GE 293, GE 393, GE 499, Bioeng 270, Bioeng 370a, Bioeng 370b, and Rehab 344. He developed both Bioeng 370 courses, Rehabilitation Engineers Design. He has received a grant from the Rehabilitation Services Administration to train graduate engineering students in

the field of rehabilitation engineering. He also developed Rehab 344.

He received a grant from the National Science Foundation to create and administer a unique undergraduate design course in which engineering students design and build solutions to problems faced by persons with disabilities in Illinois. He most recently received an NSF grant to research the causes for the underrepresentation of persons with disabilities in science, engineering, and mathematics college programs and careers.

His research is in three areas. One is to improve the understanding of how the characteristics of manual wheelchair propulsion affect the wheelchair user. Another is the development of an orientation device for those persons who are blind, or possess other orientation disabilities. A third area is understanding and eliminating underrepresentation of people with disabilities in science, engineering, and mathematics.

He has been called upon to do consulting by a large number of companies and government agencies dealing with the disabled. He has presented papers at various technical society meetings and has had them appear in conference proceedings and refereed journals.

Harrison Streeter

BS, Div. of Special Services/War Veteran, University of Illinois, 1949

LLB, University of Illinois, 1951

BS, Mechanical Engr., University of Illinois, 1962

MS, Industrial Engr., University of Illinois, 1965

PhD, Industrial Engr., University of Iowa, 1967

After serving in the U.S. Navy as a Petty Officer Third Class from June 1944 to June 1946, Harrison Streeter enrolled in a special bachelor's degree program designed for returning veterans. He then obtained a law degree and practiced law from 1951 to 1956, at which time he joined the Department of General Engineering as an instructor to teach GE 292, Engineering Law. He also began working on his BS degree in mechanical engineering. He continued his academic studies and obtained his BS in mechanical engineering in 1962 and an MS in mechanical engineering in 1965. He then took a two-year leave of absence to obtain a PhD in industrial engineering in 1967 from the University of Iowa.

In 1963, he organized the General Engineering Honor Society, Gamma Epsilon, and was its faculty adviser until his retirement. In 1961, he was the first editor of the GE Alumni Newsletter. In 1962, he established the course GE 282, Patent Law.

His research interests were in the field of tactile sensitivity and professional liability. In 1988, John Wiley & Sons published his book, *Professional Liability of Architects and Engineers*. He also co-authored an engineering graphics workbook.

In 1988, Streeter was awarded the College of Engineering Stanley H. Pierce Award for outstanding teaching. He was active in a wide range of professional and honorary societies. He was promoted to associate professor in 1968. He had a joint appointment in the Department of Mechanical and Industrial Engineering.



As an interesting side-light, he and Jerry S. Dobrovolny were office mates prior to Dobrovolny becoming department head. At one of the College of Engineering Open House programs, Dobrovolny suggested that Streeter ask Dobrovolny's secretary for a date. He did, and they were subsequently married prior to his going to Iowa for his PhD program. His wife went along and while there she completed her BS in education upon returning to Illinois, she taught high school in Mahomet, Illinois.

Streeter retired in August 1990. Since his retirement, he has continued during the summers advising incoming freshmen to the College of Engineering.

James R. Tague

BS, Civil Engr., United States Naval Academy, 1919

Prior to coming to the University of Illinois, James R. "Dinty" Tague had a distinguished career in the U.S. Navy from 1919 to 1949. He became a naval aviator in 1924. He served on battleships, destroyers, submarines, cruisers, and aircraft carriers. He commissioned the aircraft carrier Antietam and served as her captain until 1945. He finished his tour of duty on shore until his retirement in 1949.

In May of 1953, he wrote Department Head R. P. Hoelscher indicating he was bored with retirement and wondered about a possible teaching position. He was employed as an instructor in the fall of 1953. He was promoted to assistant professor in 1957. He taught GE 101, GE 102, and GE 220. One of his outstanding attributes was his smile and the twinkle in his eye. In 1959, Dean W. L. Everitt appointed him chairman of the search committee for a new department head. The committee recommended Jerry S. Dobrovolny. Tague retired in 1963.

Randall L. Thompson

BS, Educ., Kansas State College, 1966
MS, Tech. Teaching Educ., Kansas State College
1968
Post Bacc. Cert. Electronics, University of Illinois,
1969

Randall L. Thompson came to the University of Illinois as a participant in a National Science Foundation sponsored Academic Year Institute in Electronics and obtained a Post Baccalaureate Certificate in the Teaching of Electronics in 1968-69. In 1969, the Department of General Engineering received a grant of \$183,170 from the NSF for the support of the development of core courses for a two-year Associate Degree Program in Electronics Technology. The grant was conducted with Parkland College and five other community colleges in Illinois to insure the involvement of subject matter specialists in the teaching field.

Thompson was one of the outstanding participants in the 1968-69 Academic Year Institute and was asked to stay on to assist in the curriculum program as specialist in engineering technology. He joined the project in July 1969 and stayed until October 1970 when he resigned to accept an EPDA fellowship to continue his doctoral studies in education.

S. Daniel Thompson

BS, Mining Engr., West Virginia University, 1979
MS, Mining Engr., West Virginia University, 1981
PhD, Mining Engr., West Virginia University, 1985

While pursuing his education, S. Daniel Thompson worked summers in various underground mine operations. After his master's degree, he worked from August 1981 to September 1982 for the U.S. Steel Corp. Coal Division, addressing problems in materials handling, rock blasting, mine machinery, and safety. He returned to work on his PhD in 1982 under a fellowship.

He taught GE 103, GE 221, GE 288, GE 242, and GE 393. His research interests are in applying optimization techniques in materials handling problems and manufacturing engineering. He has published a number of papers in refereed journals and conference proceedings. In 1994, he returned to West Virginia University.



Deborah L. Thurston

BS, Civil Engr., University of Minnesota, 1978
MS, Civil Engr., Massachusetts Institute of Technology, 1984
PhD, Civil Engr., Massachusetts Institute of Technology, 1987

After obtaining her BS degree, Deborah L. Thurston was employed by the Minnesota Pollution Control



Agency from June 1978 to August 1982, where she became the state manager of the Innovative/Alternative Technology Program and was recognized with an Outstanding Performance Award in 1981. She enrolled at MIT in 1982 to pursue her graduate work. She had research assistantships in the Materials Systems Laboratory.

She joined the Department of General Engineering in the fall of 1987 as an assistant professor and was promoted to associate professor in 1993. She has joint appointments in the departments of Civil Engineering and Mechanical and Industrial Engineering. In 1989, she was awarded the National Science Foundation's prestigious Presidential Young Investigator Award. In 1992, she was awarded the Xerox Award for Faculty Research in the College of Engineering.

Her research activities are in the area of engineering design theory and methodology as they relate to the design-evaluate-redesign cycle of the concurrent engineering process. She has developed a theory of normative decision analysis to remedy problems in the manufacturing sector. She integrates rigorous methods for multiple-attribute design evaluations under uncertainty into computer aides to design such as expert systems. The result is new methodology that progresses beyond the automation of inadequate design procedures of the past. Her research has been well supported by industry and the National Science Foundation.

She has taught GE 288, GE 242, GE 393, and GE 493. At the graduate level, she developed a new course, GE 444, Decision Making with Multiattribute Utilities Analysis, as well as supervising master's and doctoral students in their research.

In the publication area, she has contributed chapters to several books, as well as having her papers published in refereed journals and conference proceedings. She is a registered professional engineer and a member of the American Society of Mechanical Engineers, Institute of Electrical and Electronics Engineers, Institute of Indus-

trial Engineers, and ORSA. She serves as associate technical editor in design theory and methodology for the *ASME Journal of Mechanical Design*, and also as area editor for the *Engineering Economist*.

Leonard D. Walker

BS, Civil Engr., South Dakota School of Mines, 1925
MS, Civil Engr., University of Illinois, 1932
Civil Engr., South Dakota State School of Mines, 1934

Leonard D. Walker joined the Department of General Engineering Drawing in 1926 as an assistant. He rose

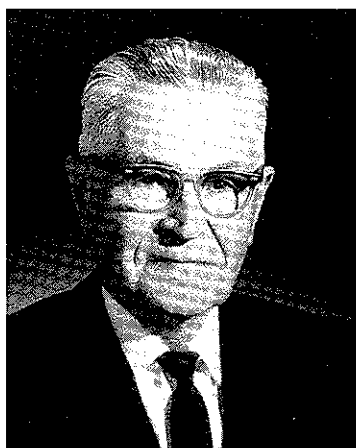

through the ranks to full professor in 1949. He taught various engineering graphics courses, including GE 106 for chemical engineers. He also taught surveying in the summer camps conducted by the Department of Civil Engineering. He handled the correspondence course load for GE 101. He was diligent in his role as department inventory control officer.

During the second semester of 1962–63, he went on disability leave until his retirement on September 1, 1964. He died on November 28, 1974.

Grace Wilson

BS, Architecture, University of Illinois, 1931
MS, Architecture, University of Illinois, 1943

After graduation in 1931, Grace Wilson worked for a number of architectural design firms in the Chicago area. In 1936, she received a Certificate in Dress Design from the Chicago Academy of Fine Arts. From 1941 to 1944, she taught mechanical and architectural drawing at Champaign High School. She was a member of the Women's Army Corps from June 1944 to October 30, 1945. After her service experience, she was employed by the University of Illinois Small Homes Research Council from November 1945 to March 1946. Then for a few months, she worked for a local architect designing homes and schools. She joined the Department of General Engineering as an instructor in the fall of 1946. Her original appointment was temporary, since her father, W. M. Wilson, was on the faculty in the Department of Civil Engineering. When he retired in 1949, she became a permanent employee. She rose through the ranks to full professor in 1972.

She taught GE 107 and GE 108 for architectural students. She also taught GE 101 and GE 103. She co-authored eight workbooks with problems in geometry for architects. She also co-authored a textbook, *Geometry for Architects*. She was highly respected by her students.

In 1961, she helped organize the student chapter of

the Women's Engineering Society and was the faculty adviser for many years. She was also active in various professional societies, including American Society for Engineering Education, American Institute of Architecture, Illinois Society of Professional Engineers, and Society of Women Engineers. In 1965, she became the editor of the *General Engineering Alumni News*. In 1978, she received the 15th Medallion of Honor from the University of Illinois Mother's Association. She retired in 1973, but continued as an emerita on a part-time basis as editor of the alumni newsletter until 1982.



Thomas R. Woodley

BS, Military Engr., United States Military Academy, 1951
MS, Theoretical and Applied Mechanics, University of Illinois, 1958
PhD, Theoretical and Applied Mechanics, University of Illinois, 1979

Prior to coming to the University of Illinois, Thomas R. Woodley had a distinguished career in the U. S. Army. From 1951 to 1955, he served as a troop commander in various commands including West Germany. From 1955 to 1957, he went to school at the U.S. Army Armor School. In 1957–58, he earned his master's degree in

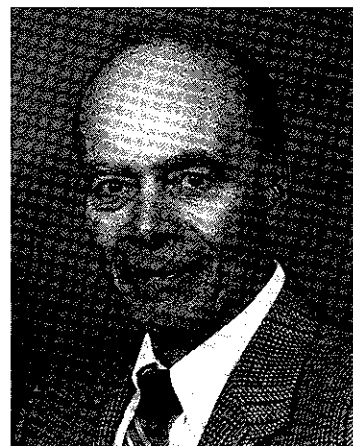

engineering mechanics at the University of Illinois. After that, he taught mechanics from 1958–61 at the U.S. Military Academy. In 1961 and 1962, he was an inspector general for the

1st Cavalry Division in South Korea. He then served as a test officer for the U.S. Army Armor and Engineering Board in Fort Knox, Kentucky, from 1962 to 1965. After six months at the U.S. Army Command and General Staff College, he returned to command the 2nd Armored Cavalry in Amberg, West Germany, until May 1966. From 1966 until 1969, he was at the Pentagon in the Office of the Chief of Research and Development. After that, he had several troop commands until he came to the University of Illinois as professor and head of the Military Science Department as a colonel from 1972 to 1975. He was then selected as director of instrumentation of the U.S. Army Combat Development Experimental Center at Camp Roberts, California. However, because of family considerations, he elected to retire from the army.

He then enrolled in the PhD program in the Department of Theoretical and Applied Mechanics at the University of Illinois from 1975 to 1978 and was a teaching assistant. He was a visiting lecturer in the Department of Mechanical and Industrial Engineering in 1979; visiting assistant professor in Mechanical and Industrial Engineering in 1980; and joined the Department of General Engineering as a lecturer in 1980. He became an associate professor in 1985.

His teaching has covered a wide range of courses, including TAM 156, TAM 221, ME 220, ME 224, GE 220, GE 232, GE 234, GE 393, GE 234, GE 242, and developing new methods for teaching GE 103. In this latter capacity, he collaborated with Michael H. Pleck in Project EXCEL whereby the use of microcomputers was adapted to the instruction of GE 103, Engineering Design Graphics. He also helped develop the use of networked microcomputers in teaching all of the general engineering design sequence and to teaching computer-aided design as a part of the upper division sequence of design courses. He and Pleck received national recognition for the adaptation and use of Auto-CAD in the teaching of engineering graphics. They presented many papers and presentations to vendor organizations, as well as technical societies.

All of his students rated him as an outstanding teacher. In teaching GE 220, History of Engineering, he was particularly recognized for his effectiveness. He retired in January 1994.

Louis Wozniak

BS, Mechanical Engr., University of Illinois, 1961
 MS, Electrical Engr., University of Illinois, 1963
 PhD, Electrical Engr., University of Illinois, 1967

Louis Wozniak joined the Department of General Engineering in 1966 as an instructor. He was a graduate assistant in the Department of Mechanical and Industrial

Engineering from 1961 to 1966. He became an associate professor in 1972. He has a joint appointment with the Department of Mechanical and Industrial Engineering and graduate standing in the Department of Electrical and Computer Engineering.

His research expertise is in the area of digital control theory with applications to control and dynamic mechanical systems. The specific application has been to optimal speed control of hydro power generating systems. He has had support for his research from the Woodward Governor Co. as well as grants from the Bureau of Reclamation, U.S. Department of the Interior, for projects ranging from development of methodology to field application.

He has been active in a number of technical societies, including being elected to the Energy Development

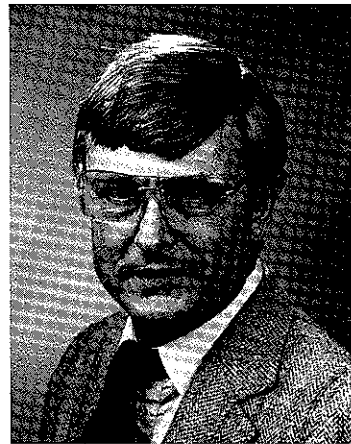

and Power Generating Committee of the Institute of Electrical and Electronics Engineers Power Engineering Society. He has published some 30 papers in refereed journals. In 1990 and again in 1993, he was awarded the prize for the best papers before the IEEE Energy Development and Power Generators Committee. In 1994, he

was elected to serve as chair of the Papers and Sessions Committee of EDPGC and was honored by being named a fellow of IEEE.

His contracts with industry obtained donations to the Department of General Engineering, including: an analog computer from General Electric Co., an AD5 analog computer from the Sundstrand Corp., two EA1680 analog computers from Babcock and Wilcox Corp.

He has been one of the most versatile teachers in the department, having taught GE 101, GE 103, GE 193, GE 221, GE 222, GE 234, GE 236, GE 242, GE 293, GE 313, GE 324, and GE 393, as well as ME 186, ME 312, ME 388, and ECE 260. He has developed and co-developed GE 222, GE 234, and GE 324, including instructional procedures, class notes, and laboratories. Wozniak has videotaped both GE 222 and GE 324. He teaches these courses statewide through the Office of Continuing Engineering Education.

He has supervised graduate students from the Department of General Engineering, Electrical and Computer Engineering, and Mechanical and Industrial Engineering. He is well respected by his students, and has been cited repeatedly for his advising excellence. He has served as faculty adviser to ISGE.

Appendix

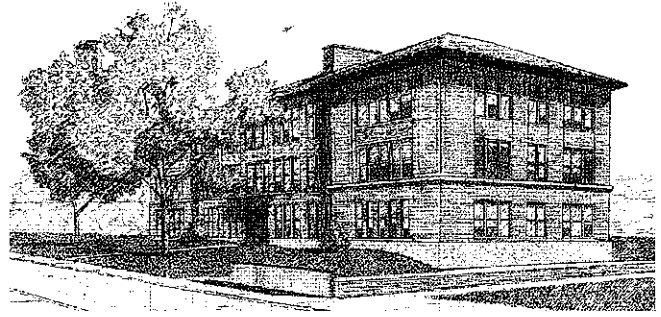

Table of Contents, Proceedings of the Fifth
Conference on Engineering Design and
Design Education, July 15-16, 1971,
University of Illinois at Urbana-Champaign.

FIFTH CONFERENCE ON ENGINEERING DESIGN AND DESIGN EDUCATION

TABLE OF CONTENTS

OPENING THE SESSION—Welcome and Response 1

Greetings

Jerry S. Dobrovolny, Head, Department of General Engineering, University of Illinois, Urbana-Champaign

Appreciation

Clark P. Mangelsdorf, Design Committee, American Society for Engineering Education

KEYNOTE ADDRESS

Transportation Systems as a Field of Engineering Design Opportunity

W. Crawford Dunlap, Science Adviser, Transportation Systems Center, Cambridge, Massachusetts 2

SESSION I — SYSTEMS ASPECTS OF DESIGN

INTRODUCTION TO PANEL REPORTS

Clean Air Car Race—Systems Approach to Design 6

Stephen R. Davis, Wayne State University, Detroit, Michigan

Report I—A Student's Comments on 1970 Clean-Air Car Race 8

Bruce D. Peters, Graduate in Mechanical Engineering, University of Wisconsin, Madison

Report II—Urban Vehicle Design Competition—An Educational Experience 9

Tom Quaka, Undergraduate in Mechanical Engineering, University of Illinois, Urbana

MAJOR PAPER

Computer-Aided Design 11

Rudolph L. Motard, Head, Hybrid Systems Laboratory, University of Houston, Texas

MAJOR ADDRESS — LUNCHEON I

Sin of Simulation 18

Robert A. Frosch, Assistant Secretary of the Navy (Research and Development), Washington, D.C.

SESSION II—ENGINEERING DESIGN EDUCATION TOWARD A "NEW BREED" OF ENGINEERS

INTRODUCTION TO PANEL REPORTS

Directions of Sloan Foundation Design-Sponsorship Grants 23

Lucius Gregg, Program Officer, Sloan Foundation, Detroit, Michigan

COMMENTS OF SLOAN PROGRAM PARTICIPANTS

Report I

Interdisciplinary Design Program for North-Side Chicago 24

Gustave J. Rath, Director, Design and Development Center, Northwestern University, Evanston, Illinois

Report II

Systems Engineering: Content, Applications, Student Involvement 26

Clark P. Mangelsdorf, Environmental Systems Engineering Group, University of Pittsburgh, Pennsylvania

Report III

Producing Design and Development-Oriented Engineering Decision-Makers 28
Charles O. Smith, Director, Sloan Program, University of Detroit, Michigan

Report IV

Interdisciplinary Study in a New "Project" Curriculum 29
Imre Zwiebel, Director, Environmental Systems Study Program, Worcester Polytechnic Institute, Massachusetts

Report V

New Design Curriculum with Societal Orientation 31
George Leppert, Clarkson College of Technology, Potsdam, New York

SESSION III – UNDERGRADUATE ENGINEERING DESIGN

The Freshman Course: Problems and Prospects in Motivating the First-Year Engineer 33
Roland L. Ruhl, Department of General Engineering, University of Illinois, Urbana-Champaign

Senior Design Projects 35
James Adams, Stanford University, Palo Alto, California

Evaluation of Design Projects 37
Percy Hill, Tufts University, Medford, Massachusetts

Team Teaching in Engineering Design 40
L. Daniel Metz, University of Illinois, Urbana-Champaign

Industry Involvement in Engineering Design Education 43
Herbert Sumner, Manager, Administration and Services, Deere & Co. Technical Center, East Moline, Illinois

MAJOR ADDRESS – DINNER

Historical Perspective of Engineering Design as it Relates to Society Today 45
Melvin Kranzberg, Case Western Reserve University, Cleveland, Ohio; Editor, *Technology and Culture*

SESSION IV – GRADUATE ENGINEERING DESIGN

Tool for Engineering Design of our Future 52
John McLeod, La Jolla, California; Editor, *Simulation*

Interdisciplinary Programs in Engineering Design 54
Peter Roe, University of Waterloo, Ontario, Canada

Engineering Design and Societal Needs 57
Bruce Lusigman, Stanford University, Palo Alto, California

Design in a Research Environment—NASA Program 60
Joseph Vitale, Chief, Engineering Systems Design Branch, National Aeronautics and Space Administration, Washington, D.C.

MAJOR ADDRESS – LUNCHEON II

Future Funding Patterns of Governmental Agencies as They Affect Engineering Design Education 65
Alfred J. Eggers, Assistant Director for Applied Research, National Science Foundation, Washington, D.C.

APPENDIX: Contributors—Listed Alphabetically and in Presentation Order
Conference Participants and Program Contributors—Alphabetical Listing